



**ORTHODONTICS®**

Quality Manufacturing. Exceptional Service.



Real patients wearing Vapor™ and miniPrevail® G&H manufactured brackets.

See and order our full line of products at [GHOrthodontics.com](http://GHOrthodontics.com)

**ORTHODONTIC PRODUCTS CATALOG**

Volume 13



## **“Quick Reorder”**

### **The easiest way yet to order products**

G&H® makes reordering products a breeze with our online **“Quick Reorder”** feature.

- View your 2-year order history
- Reorder what you want with a few clicks
- Create or reset your login at [GHOrthodontics.com](http://GHOrthodontics.com)

#### **How to Order**



**Web Orders:**  
[www.GHOrthodontics.com](http://www.GHOrthodontics.com)



**Phone Orders:**  
Toll-free within the USA and Canada  
888-723-7860, or dial +1 317-346-6655  
• Our phone lines are open Monday through Friday from 7:00 a.m. to 5:00 p.m. (EST)



**Email Orders:**  
[orders@ghortho.com](mailto:orders@ghortho.com)



**Our Mission – “To provide our customers a great experience achieved through quality manufacturing and exceptional service.”**

**GHOrthodontics.com • Toll-Free 888-723-7860 • [orders@ghortho.com](mailto:orders@ghortho.com)**

# Table of Contents

## Brackets | Bands | Tubes.....2

### Metal Brackets

miniPrevail™.....	3-6
Focus™ Bracket System.....	7-9
AGILITY® Self-Ligating Passive Bracket System.....	10-13
Agility® Clip Opening Instrument.....	11

### Cosmetic Brackets

Vapor™ Ceramic Bracket System.....	14-16
Prism™ Composite Bracket System.....	17-19

### Buccal Tubes

Viper™ Low Profile Buccal Tubes.....	20-22
Viper™ Low Profile Mini 2nd Tube.....	22
Viper™ CV Low Profile Convertible Tube.....	23
Viper™ CV Combination Convertible Tube.....	24
Magnum™ Buccal Tubes.....	24-28

### Bands & Attachments

Titan™ Molar Bands.....	30-31
Saturn™ Molar Bands.....	32-33
Bicuspid Bands.....	33
Lingual Attachments.....	34

## Wire Products | Springs.....35

Archform Options.....	37-39
Recovery Force Graphs.....	41
G4™ Nickel Titanium Archwires.....	44-45
G4orce™ Progressive Force NiTi Archwires.....	46
Pre-Stopped G4™ NiTi Archwires.....	52
DYB™ Pre-Torqued Archwires.....	50, 51
Pre-Torqued NiTi Archwires.....	52, 54
Reverse Curve NiTi Archwires.....	53
M5™ Thermal Nickel Titanium Archwires.....	42, 43
BT3™ Beta Titanium Archwires.....	55
Stainless Steel Archwires.....	56
Heat-Treated Stainless Steel Archwires.....	57
Looped Archwires.....	58
Posted Archwires.....	59
Ultraesthetic Tooth-Colored Archwires.....	60
Lingual Archwires.....	61-63
Multi-Strand Stainless Steel Archwires.....	64
Straight Lengths, Spools & Lab Wire.....	65
Nickel Cobalt Archwires.....	66
Australian Wire Products.....	67, 68

### Spring & Auxiliaries

G4™ Nickel Titanium Closed Coil Springs.....	69
G4™ NiTi TAD Springs.....	69
Open and Closed Coil Springs.....	70
Crimpable Hooks and Stops.....	71
Stainless Steel Open and Closed Coil Springs.....	70
Expansion Screws.....	72
Palatal Arch Bars.....	71

## Elastomeric Products.....73

Elastic Thread/Tubing.....	74
Elastomeric Separators.....	74
Latex Elastics/Non-Latex Elastics.....	74-75
Private Logo Elastics.....	76
Elastomeric Ligature Ties.....	77
Elastomeric Chain.....	79, 80

## Clinical Supplies.....81

### Bonding Supplies

Reliance Bonding Products.....	82-84
Mixing Tips & Brushes.....	86
Mixing Pads, Wells, Dappen Dishes.....	87
Saliva Ejectors/Oral Evacuators.....	88
Retractors.....	89
SmartBond® Wet Field Bonding Adhesive.....	90
Mini-Mold™ Kit & Bite Bumpers.....	91
Curing Light (LEDEX™).....	92

### Extraoral & Finishing

Protraction Face Masks.....	93
Facebows & Lip Bumpers.....	94
Neckpads, Headcaps, Storage Cases.....	95
Fiber Reinforced Composite, Lingual Retention.....	96
Tooth Positioner.....	97

### Instruments

Pliers, Cutters, Wire Forming, Bracket Removal.....	98-100
Hand Instruments.....	101
Instrument Holders/Racks.....	104
Handpieces.....	105
Prophy Supplies.....	106
Burs, Abrasive Wheels, Stones.....	107-110

### Clinical Supplies

Impression Trays/Supplies.....	111-117
Plaster, Model Formers, Stone Material.....	117
Photographic Mirrors, Hand Mirrors.....	119
Cups, Headrest/Chair Covers.....	122
Gloves, Face Masks.....	125, 125
X-Ray Film, Chemistry.....	127, 128

## Office & Patient Supplies.....129

### For the Patient

Retainer Cases, Mouth Guards.....	130, 131
Floss, Toothbrushes.....	132
Patient Relief Wax.....	134
Elastic Placement Tool/Storage Cases.....	135

### Hygienic/Cleaners

Disinfecting Towelettes.....	136
General Purpose Cleaners.....	136, 137
Sterilants, Ultrasonic Cleaners.....	137
Sterilization Pouches.....	138, 139
Cotton Rolls, Gauze.....	139
Hand Soap, Lotion, Paper Towels.....	140
Eye Protection.....	141
Bio-hazard/Sharps Containers.....	142
Barrier Film.....	142

### Lab Supplies

Utility Wax.....	143, 144
Retainer Material/Plastics.....	145
Solder.....	145

### Equipment

Autoclave/Dry Heat Sterilizers.....	146
Sandblast/Grinding Containment.....	146, 147
Etchers & Supplies.....	147
Micromotors.....	148, 149
Lathes.....	149, 150
Trimmers.....	150, 151
Vibrators.....	152, 153
Plaster Traps.....	153
Vacuum Mixers.....	154
Ultrasonic Units/Waterbath.....	155
Welders.....	156
Vacuum Formers.....	157

# Brackets | Bands | Tubes



Precision engineered and manufactured with a focus on performance and patient comfort.

## miniPrevail® BRACKET SYSTEM

Manufactured by G&H® Orthodontics

**TOP SELLER!**

### A POWERFUL COMFORTABLE BRACKET SYSTEM

A true miniature twin bracket system that incorporates all the benefits of a larger bracket

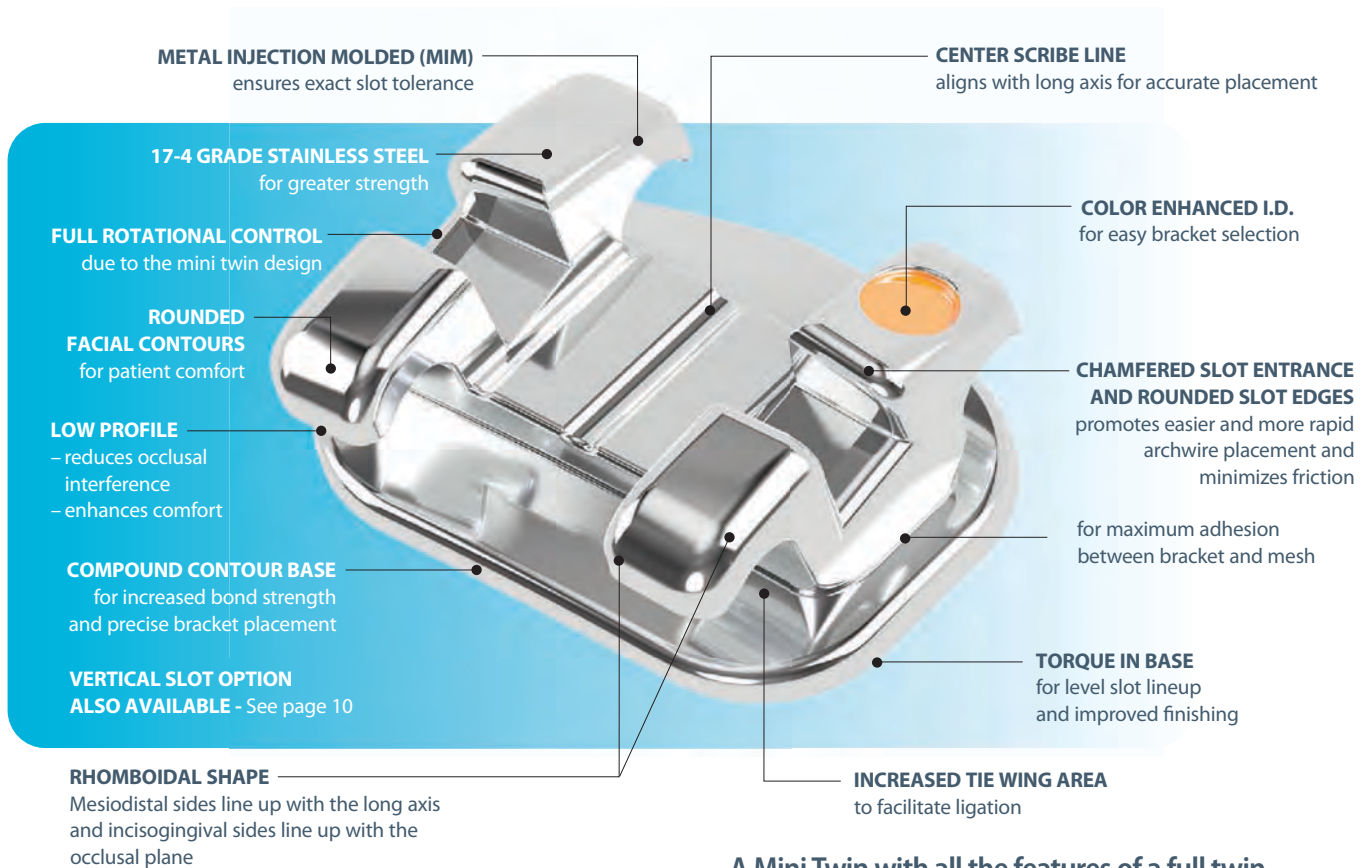

### A Mini Twin with all the features of a full twin

\*\*miniPrevail brackets are constructed of a specialized micro-grain stainless steel MIM powder, ideal for creating small, robust appliances that are inherently stronger and more dimensionally accurate than other similar brackets.



*"miniPrevail brackets are high-quality twin brackets. The base and scribe lines make for easy bracket placement. The tie wings allow for easy tie-ins with multiple ligatures if needed, but are strong and comfortable for the patient."*

– Graham Jones, D.D.S., M.S.D.



### 80 Gauge Mesh Bonding Base

Matches the anatomy of the tooth for maximum contact and a strong, consistent bond. The miniPrevail™ bracket is also designed with torque-in-base to provide level slot lineup and help avoid occlusal interference.

### miniPrevail® Bracket Identification System

			<b>UPPER RIGHT</b>		<b>UPPER LEFT</b>				
5	4	3	White 2	Orange 1	Orange 1	White 2	3	4	5
Bicuspid whk	Bicuspid whk	Cuspid whk	Lateral	Central	Central	Lateral	Cuspid whk	Bicuspid whk	Bicuspid whk
			<b>Anterior 2</b>	<b>Anterior 1</b>	<b>Anterior 1</b>	<b>Anterior 2</b>			
2nd Bicuspid	1st Bicuspid	Cuspid	<b>Black</b>	<b>Black</b>	<b>Black</b>	<b>Black</b>	3	4	5
2nd Bicuspid	1st Bicuspid	Cuspid	<b>LOWER RIGHT</b>		<b>LOWER LEFT</b>				
<b>Yellow</b>	<b>Blue</b>	<b>Green</b>					<b>Green</b>	<b>Blue</b>	<b>Yellow</b>

# MINIPREVAIL® BRACKET SYSTEM

## Roth\* Prescription

### Maxillary

Tooth	Torque	Angle	Rotation	M/D	R/L	ID	Mesh Base		Offset Mesh Base Option	
							.018	.022	.018	.022
Central	12°	5°	0°	.140"	R	●	36-U1-8R	36-U1-2R	-	-
					L	●	36-U1-8L	36-U1-2L		
Central Hi-Torque	22°	5°	0°	.140"	R	●	39-U1-8R	39-U1-2R	-	-
					L	●	39-U1-8L	39-U1-2L		
Lateral	8°	9°	0°	.115"	R	○	36-U2-8R	36-U2-2R	-	-
					L	○	36-U2-8L	36-U2-2L		
Lateral Hi-Torque	14°	9°	0°	.115"	R	○	39-U2-8R	39-U2-2R	-	-
					L	○	39-U2-8L	39-U2-2L		
Cuspid (without Hook)	0°	11°	0°	.122"	R	●	36-U3-8R	36-U3-2R	-	-
					L	●	36-U3-8L	36-U3-2L		
Cuspid Hk (with Hook)	0°	11°	0°	.122"	R	●	36-U3-8RK	36-U3-2RK	-	-
					L	●	36-U3-8LK	36-U3-2LK		
Bicuspid	-7°	0°	0°	.122"	U	●●	36-U4-8U	36-U4-2U	36-U4-8UO	36-U4-2UO
Bicuspid Hk	-7°	0°	0°	.122"	R	●	36-U4-8RK	36-U4-2RK	36-U4-8RKO	36-U4-2RKO
					L	●	36-U4-8LK	36-U4-2LK		

### Mandibular

Tooth	Torque	Angle	Rotation	M/D	R/L	ID	Mesh Base		Offset Mesh Base Option	
							.018	.022	.018	.022
Anterior	0°	0°	0°	.100"	U	●●	36-L1-8U	36-L1-2U	-	-
Cuspid (without Hook)	-11°	5°	0°	.122"	R	●	36-L3-8R	36-L3-2R	-	-
					L	●	36-L3-8L	36-L3-2L		
Cuspid Hk (with Hook)	-11°	5°	0°	.122"	R	●	36-L3-8RK	36-L3-2RK	-	-
					L	●	36-L3-8LK	36-L3-2LK		
1 <sup>st</sup> Bicuspid	-17°	0°	0°	.122"	U	●●	36-L4-8U	36-L4-2U	36-L4-8UO	36-L4-2UO
1 <sup>st</sup> Bicuspid Hk	-17°	0°	0°	.122"	R	●	36-L4-8RK	36-L4-2RK	36-L4-8RKO	36-L4-2RKO
					L	●	36-L4-8LK	36-L4-2LK		
2 <sup>nd</sup> Bicuspid	-22°	0°	0°	.122"	U	●●	36-L5-8U	36-L5-2U	36-L5-8UO	36-L5-2UO
2 <sup>nd</sup> Bicuspid Hk	-22°	0°	0°	.122"	R	●	36-L5-8RK	36-L5-2RK	36-L5-8RKO	36-L5-2RKO
					L	●	36-L5-8LK	36-L5-2LK		

#### Patient Kits - Roth\* Rx

	.018	.022	Offset Mesh Base Option**	
			.018	.022
Upper/Lower 5x5 Hook on 3	36K-3-18-01	36K-3-22-01	36KO-3-18-01	36KO-3-22-01
Upper/Lower 5x5 Hook on 3, 4, & 5	36K-345-18-01	36K-345-22-01	36KO-345-18-01	36KO-345-22-01

Brackets are packaged with 1 case oriented in a kit box.  
 Brackets are also available as kits in bags.  
 Brackets are also available in kits of 5 or 10 cases oriented in a carousel dispenser.

Custom kits with different bracket configurations available on request.

\*\*Indicates bicuspid brackets with offset base.

\*G&H® bracket prescriptions are not implied to be an exact version of any other system, nor do we claim any endorsement by the doctor.  
 MBT is a trademark of 3M Unitek Corporation.

## MINIPREVAIL® BRACKET SYSTEM

### MBT® Prescription

#### Maxillary

Tooth	Torque	Angle	Rotation	M/D	R/L	ID	Mesh Base		Offset Mesh Base Option	
							.018	.022	.018	.022
Central	17°	4°	0°	.140"	R L	● ●	37-U1-8R 37-U1-8L	37-U1-2R 37-U1-2L	-	-
Lateral	10°	8°	0°	.115"	R L	○ ○	37-U2-8R 37-U2-8L	37-U2-2R 37-U2-2L	-	-
Cuspid (without Hook)	-7°	8°	0°	.122"	R L	● ●	37-U3-8R 37-U3-8L	37-U3-2R 37-U3-2L	-	-
Cuspid Hk (with Hook)	-7°	8°	0°	.122"	R L	● ●	37-U3-8RK 37-U3-8LK	37-U3-2RK 37-U3-2LK	-	-
Cuspid (without Hook)	0°	8°	0°	.122"	R L	● ●	37-U3-8R0 37-U3-8L0	37-U3-2R0 37-U3-2L0	-	-
Cuspid Hk (with Hook)	0°	8°	0°	.122"	R L	● ●	37-U3-8RK0 37-U3-8LK0	37-U3-2RK0 37-U3-2LK0	-	-
Bicuspid	-7°	0°	0°	.122"	U	●●	37-U4-8U	37-U4-2U	37-U4-8UO	37-U4-2UO
Bicuspid Hk	-7°	0°	0°	.122"	R L	● ●	37-U4-8RK 37-U4-8LK	37-U4-2RK 37-U4-2LK	37-U4-8RK0 37-U4-8LK0	37-U4-2RK0 37-U4-2LK0

#### Mandibular

Tooth	Torque	Angle	Rotation	M/D	R/L	ID	Mesh Base		Offset Mesh Base Option	
							.018	.022	.018	.022
Anterior	-6°	0°	0°	.100"	U	●●	37-L1-8U	37-L1-2U	-	-
Cuspid (without Hook)	-6°	3°	0°	.122"	R L	● ●	37-L3-8R 37-L3-8L	37-L3-2R 37-L3-2L	-	-
Cuspid Hk (with Hook)	-6°	3°	0°	.122"	R L	● ●	37-L3-8RK 37-L3-8LK	37-L3-2RK 37-L3-2LK	-	-
Cuspid (without Hook)	0°	3°	0°	.122"	R L	● ●	37-L3-8R0 37-L3-8L0	37-L3-2R0 37-L3-2L0	-	-
Cuspid Hk (with Hook)	0°	3°	0°	.122"	R L	● ●	37-L3-8RK0 37-L3-8LK0	37-L3-2RK0 37-L3-2LK0	-	-
1 <sup>st</sup> Bicuspid	-12°	0°	0°	.122"	U	●●	37-L4-8U	37-L4-2U	37-L4-8UO	37-L4-2UO
1 <sup>st</sup> Bicuspid Hk	-12°	0°	0°	.122"	R L	● ●	37-L4-8RK 37-L4-8LK	37-L4-2RK 37-L4-2LK	37-L4-8RK0 37-L4-8LK0	37-L4-2RK0 37-L4-2LK0
2 <sup>nd</sup> Bicuspid	-17°	0°	0°	.122"	U	●●	37-L5-8U	37-L5-2U	37-L5-8UO	37-L4-2UO
2 <sup>nd</sup> Bicuspid Hk	-17°	0°	0°	.122"	R L	● ●	37-L5-8RK 37-L5-8LK	37-L5-2RK 37-L5-2LK	37-L5-8RK0 37-L5-8LK0	37-L5-2RK0 37-L5-2LK0

Patient Kits - MBT® Rx	Mesh Base		Offset Mesh Base Option**	
	.018	.022	.018	.022
Upper/Lower 5x5 Hook on 3	37K-3-18-01	37K-3-22-01	37KO-3-18-01	37KO-3-22-01
Upper/Lower 5x5 Hook on 3, 4, & 5	37K-345-18-01	37K-345-22-01	37KO-345-18-01	37KO-345-22-01

MBT Rx kits include 0° torque on the cuspids - custom kits available upon request.  
 Brackets are packaged with 1 case oriented in a kit box.  
 Brackets are also available as kits in bags.  
 Brackets are also available in kits of 5 or 10 cases oriented in a carousel dispenser.

Custom kits with different bracket configurations available on request.

\*\*Indicates bicuspid brackets with offset base.

\*G&H® bracket prescriptions are not implied to be an exact version of any other system, nor do we claim any endorsement by the doctor.  
 MBT is a trademark of 3M Unitek Corporation.

# MINIPREVAIL® BRACKET SYSTEM

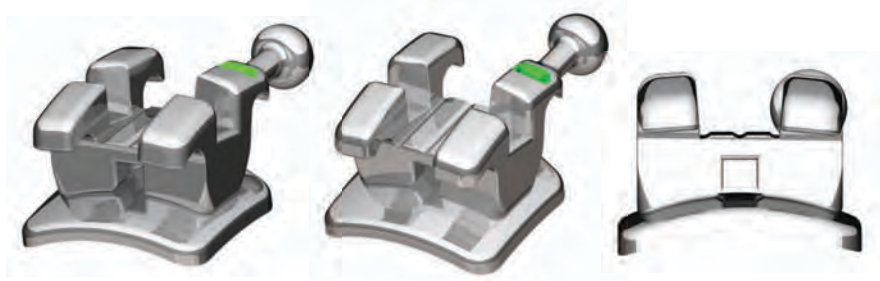

## Roth® V-Slot Prescription – Vertical slot measures .018x.018

### Maxillary

Tooth	Torque	Angle	Rotation	M/D	R/L	ID	Mesh Base		Offset Mesh Base Option	
							.018	.022	.018	.022
Central	12°	5°	0°	.140"	R	●	38-U1-8R	38-U1-2R	–	–
					L	●	38-U1-8L	38-U1-2L		
Lateral	8°	9°	0°	.115"	R	○	38-U2-8R	38-U2-2R	–	–
					L	○	38-U2-8L	38-U2-2L		
Cuspid (without Hook)	0°	11°	0°	.122"	R	●	38-U3-8R	38-U3-2R	–	–
					L	●	38-U3-8L	38-U3-2L		
Cuspid Hk (with Hook)	0°	11°	0°	.122"	R	●	38-U3-8RK	38-U3-2RK	–	–
					L	●	38-U3-8LK	38-U3-2LK		
Bicuspid	-7°	0°	0°	.122"	U	●●	38-U4-8U	38-U4-2U	38-U4-8UO	38-U4-2UO
Bicuspid Hk	-7°	0°	0°	.122"	R	●	38-U4-8RK	38-U4-2RK	38-U4-8RKO	38-U4-2RKO
					L	●	38-U4-8LK	38-U4-2LK		

### Mandibular

Tooth	Torque	Angle	Rotation	M/D	R/L	ID	Mesh Base		Offset Mesh Base Option	
							.018	.022	.018	.022
Anterior	0°	0°	0°	.100"	U	●●	38-L1-8U	38-L1-2U	–	–
Cuspid (without Hook)	-11°	5°	0°	.122"	R	●	38-L3-8R	38-L3-2R	–	–
					L	●	38-L3-8L	38-L3-2L		
Cuspid Hk (with Hook)	-11°	5°	0°	.122"	R	●	38-L3-8RK	38-L3-2RK	–	–
					L	●	38-L3-8LK	38-L3-2LK		
1 <sup>st</sup> Bicuspid	-17°	0°	0°	.122"	U	●●	38-L4-8U	38-L4-2U	38-L4-8UO	38-L4-2UO
1 <sup>st</sup> Bicuspid Hk	-17°	0°	0°	.122"	R	●	38-L4-8RK	38-L4-2RK	38-L4-8RKO	38-L4-2RKO
					L	●	38-L4-8LK	38-L4-2LK		
2 <sup>nd</sup> Bicuspid	-22°	0°	0°	.122"	U	●●	38-L5-8U	38-L5-2U	38-L5-8UO	38-L5-2UO
2 <sup>nd</sup> Bicuspid Hk	-22°	0°	0°	.122"	R	●	38-L5-8RK	38-L5-2RK	38-L5-8RKO	38-L5-2RKO
					L	●	38-L5-8LK	38-L5-2LK		

Patient Kits - Roth® Rx	Offset Mesh Base Option**			
	.018	.022	.018	.022
Upper/Lower 5x5 Hook on 3	38K-3-18-01	38K-3-22-01	38KO-3-18-01	38KO-3-22-01
Upper/Lower 5x5 Hook on 3, 4, & 5	38K-345-18-01	38K-345-22-01	38KO-345-18-01	38KO-345-22-01

Brackets are packaged with 1 case oriented in a kit box.  
 Brackets are also available as kits in bags.  
 Brackets are also available in kits of 5 or 10 cases oriented in a carousel dispenser.  
 Custom kits with different bracket configurations available on request.

\*\*Indicates bicuspid brackets with offset base.

\*G&H® bracket prescriptions are not implied to be an exact version of any other system, nor do we claim any endorsement by the doctor.  
 MBT is a trademark of 3M Unitek Corporation.



## Focus™ BRACKET SYSTEM

Manufactured by G&H® Orthodontics

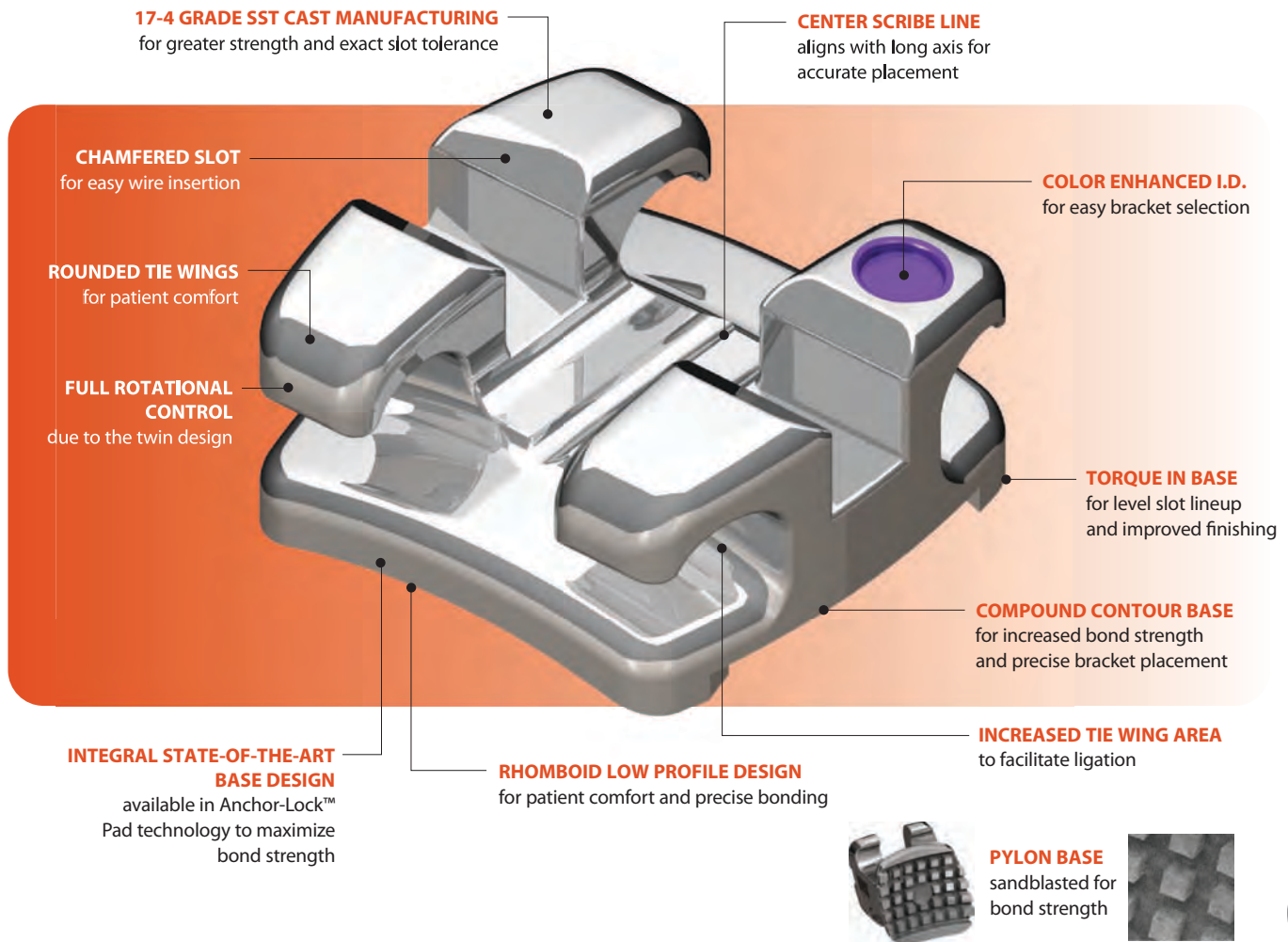

### Focus on Innovation

G&H®'s innovative Focus™ bracket system establishes a new standard for quality and reliability, offering all the advantages of a mini bracket with the control of a full size bracket.

The innovative design of the Focus™ bracket system starts from the bottom up, with an integral pylon base that provides enhanced bond strength. The Focus™ bracket is also designed with torque-in-base to provide level slot lineup and improved finishing.

**Focus on Results.**  
**Focus on Innovation.**  
**Focus on G&H®.**



Focus™ brackets applied to demonstration model

### Focus on Results

Experience uncompromising results while your patients appreciate the comfort of G&H®'s Focus™ bracket system.

The Focus™ bracket has an integral base design which allows you to take full advantage of all aspects of the prescription. This enables you to easily achieve all of your desired prescription torques and angulations.

Choosing the right bracket is key to every successful orthodontic practice. G&H®'s Focus™ bracket is precisely engineered and manufactured with an emphasis on performance and accuracy.

# FOCUS™ BRACKET SYSTEM



## Roth® Prescription

### Maxillary

Tooth	Torque	Angle	Rotation	M/D	R/L	ID	Anchor-Lock Pad	
							.018	.022
Central	12°	5°	0°	3.9 mm	R	●	19-U1-8R	19-U1-2R
					L	●	19-U1-8L	19-U1-2L
Lateral	8°	9°	0°	3.3 mm	R	○	19-U2-8R	19-U2-2R
					L	○	19-U2-8L	19-U2-2L
Cuspid (without Hook)	0°	11°	0°	3.4 mm	R	●	19-U3-8R	19-U3-2R
					L	●	19-U3-8L	19-U3-2L
Cuspid Hk (with Hook)	0°	11°	0°	3.4 mm	R	●	19-U3-8RK	19-U3-2RK
					L	●	19-U3-8LK	19-U3-2LK
1 <sup>st</sup> & 2 <sup>nd</sup> Bicuspид	-7°	0°	0°	3.4 mm	U	●●	19-U4-8U	19-U4-2U
1 <sup>st</sup> & 2 <sup>nd</sup> Bicuspид Hk	-7°	0°	0°	3.4 mm	R	●	19-U4-8RK	19-U4-2RK
					L	●	19-U4-8LK	19-U4-2LK

### Mandibular

Tooth	Torque	Angle	Rotation	M/D	R/L	ID	Anchor-Lock Pad	
							.018	.022
Anterior	0°	0°	0°	2.6 mm	U	●●	19-L1-8U	19-L1-2U
Cuspid (without Hook)	-11°	5°	0°	3.4 mm	R	●	19-L3-8R	19-L3-2R
					L	●	19-L3-8L	19-L3-2L
Cuspid Hk (with Hook)	-11°	5°	0°	3.4 mm	R	●	19-L3-8RK	19-L3-2RK
					L	●	19-L3-8LK	19-L3-2LK
1 <sup>st</sup> Bicuspид	-17°	0°	0°	3.4 mm	U	●●	19-L4-8U	19-L4-2U
1 <sup>st</sup> Bicuspид Hk	-17°	0°	0°	3.4 mm	R	●	19-L4-8RK	19-L4-2RK
					L	●	19-L4-8LK	19-L4-2LK
2 <sup>nd</sup> Bicuspид	-22°	0°	0°	3.4 mm	U	●●	19-L5-8U	19-L5-2U
2 <sup>nd</sup> Bicuspид Hk	-22°	0°	0°	3.4 mm	R	●	19-L5-8RK	19-L5-2RK
					L	●	19-L5-8LK	19-L5-2LK

### Full Sets - Roth® Rx

	.018	.022
Upper/Lower 5x5 Hook on 3	19K-3-18-01	19K-3-22-01
Upper/Lower 5x5 Hook on 3, 4, & 5	19K-345-18-01	19K-345-22-01

\*G&H® bracket prescriptions are not implied to be an exact version of any other system, nor do we claim any endorsement by the doctor. MBT is a trademark of 3M Unitek Corporation.

Brackets are packaged with 1 case oriented in a kit box.

Brackets are also available as kits in bags.

Brackets are also available in kits of 5 or 10 cases oriented in a carousel dispenser.

Custom kits with different bracket configurations can be ordered on request.

## Focus™ Bracket Identification System

UPPER RIGHT					UPPER LEFT				
Red Bicuspид	Red Bicuspид	Purple Cuspid	White Lateral	Orange Central	Orange Central	White Lateral	Purple Cuspid	Red Bicuspид	Red Bicuspид
5	4	3	2	1	1	2	3	4	5
Bicuspид w/hk	Bicuspид w/hk	Cuspid w/hk	Lateral	Central	Central	Lateral	Cuspid w/hk	Bicuspид w/hk	Bicuspид w/hk
2 <sup>nd</sup> Bic w/hk	1 <sup>st</sup> Bic w/hk	Cuspid w/hk	Anterior	Anterior	Anterior	Anterior	Cuspid w/hk	1 <sup>st</sup> Bic w/hk	2 <sup>nd</sup> Bic w/hk
5	4	3	2	1	1	2	3	4	5
2 <sup>nd</sup> Bicuspид	1 <sup>st</sup> Bicuspид	Cuspid	Black	Black	Black	Black	Green	Blue	Yellow
Yellow	Blue	Green	LOWER RIGHT		LOWER LEFT		Green	Blue	Yellow



## FOCUS™ BRACKET SYSTEM



### MBT® Prescription

#### Maxillary

Tooth	Torque	Angle	Rotation	M/D	R/L	ID	Anchor-Lock Pad	
							.018	.022
Central	17°	4°	0°	3.9 mm	R	●	21-U1-8R	21-U1-2R
					L	●	21-U1-8L	21-U1-2L
Lateral	10°	8°	0°	3.3 mm	R	○	21-U2-8R	21-U2-2R
					L	○	21-U2-8L	21-U2-2L
Cuspid (without Hook)	-7°	8°	0°	3.4 mm	R	●	21-U3-8R	21-U3-2R
					L	●	21-U3-8L	21-U3-2L
Cuspid Hk (with Hook)	-7°	8°	0°	3.4 mm	R	●	21-U3-8RK	21-U3-2RK
					L	●	21-U3-8LK	21-U3-2LK
Cuspid (without Hook)	0°	8°	0°	3.4 mm	R	●	21-U3-8R0	21-U3-2R0
					L	●	21-U3-8L0	21-U3-2L0
Cuspid Hk (with Hook)	0°	8°	0°	3.4 mm	R	●	21-U3-8RK0	21-U3-2RK0
					L	●	21-U3-8LK0	21-U3-2LK0
1 <sup>st</sup> & 2 <sup>nd</sup> Bicuspid	-7°	0°	0°	3.4 mm	U	●●	21-U4-8U	21-U4-2U
1 <sup>st</sup> & 2 <sup>nd</sup> Bicuspid Hk	-7°	0°	0°	3.4 mm	R	●	21-U4-8RK	21-U4-2RK
					L	●	21-U4-8LK	21-U4-2LK

#### Mandibular

Tooth	Torque	Angle	Rotation	M/D	R/L	ID	Anchor-Lock Pad	
							.018	.022
Anterior	-6°	0°	0°	2.6 mm	U	●●	21-L1-8U	21-L1-2U
Cuspid (without Hook)	-6°	3°	0°	3.4 mm	R	●	21-L3-8R	21-L3-2R
					L	●	21-L3-8L	21-L3-2L
Cuspid Hk (with Hook)	-6°	3°	0°	3.4 mm	R	●	21-L3-8RK	21-L3-2RK
					L	●	21-L3-8LK	21-L3-2LK
Cuspid (without Hook)	0°	3°	0°	3.4 mm	R	●	21-L3-8R0	21-L3-2R0
					L	●	21-L3-8L0	21-L3-2L0
Cuspid Hk (with Hook)	0°	3°	0°	3.4 mm	R	●	21-L3-8RK0	21-L3-2RK0
					L	●	21-L3-8LK0	21-L3-2LK0
1 <sup>st</sup> Bicuspid	-12°	0°	0°	3.4 mm	U	●●	21-L4-8U	21-L4-2U
1 <sup>st</sup> Bicuspid Hk	-12°	0°	0°	3.4 mm	R	●	21-L4-8RK	21-L4-2RK
					L	●	21-L4-8LK	21-L4-2LK
2 <sup>nd</sup> Bicuspid	-17°	0°	0°	3.4 mm	U	●●	21-L5-8U	21-L5-2U
2 <sup>nd</sup> Bicuspid Hk	-17°	0°	0°	3.4 mm	R	●	21-L5-8RK	21-L5-2RK
					L	●	21-L5-8LK	21-L5-2LK

Full Sets - MBT® Rx	.018	.022
Upper/Lower 5x5 Hook on 3	21K-3-18-01	21K-3-22-01
Upper/Lower 5x5 Hook on 3, 4, & 5	21K-345-18-01	21K-345-22-01

MBT Rx kits include 0° torque on the cuspids - custom kits available upon request.  
 Brackets are packaged with 1 case oriented in a kit box.  
 Brackets are also available as kits in bags.  
 Brackets are also available in kits of 5 or 10 cases oriented in a carousel dispenser.

Custom kits with different bracket configurations can be ordered on request.

\*G&H® bracket prescriptions are not implied to be an exact version of any other system, nor do we claim any endorsement by the doctor.  
 MBT is a trademark of 3M Unitek Corporation.

# AGILITY<sup>®</sup>

## SELF-LIGATING BRACKET SYSTEM

Manufactured by G&H<sup>®</sup> Orthodontics

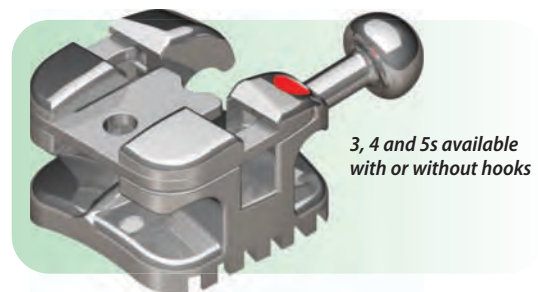
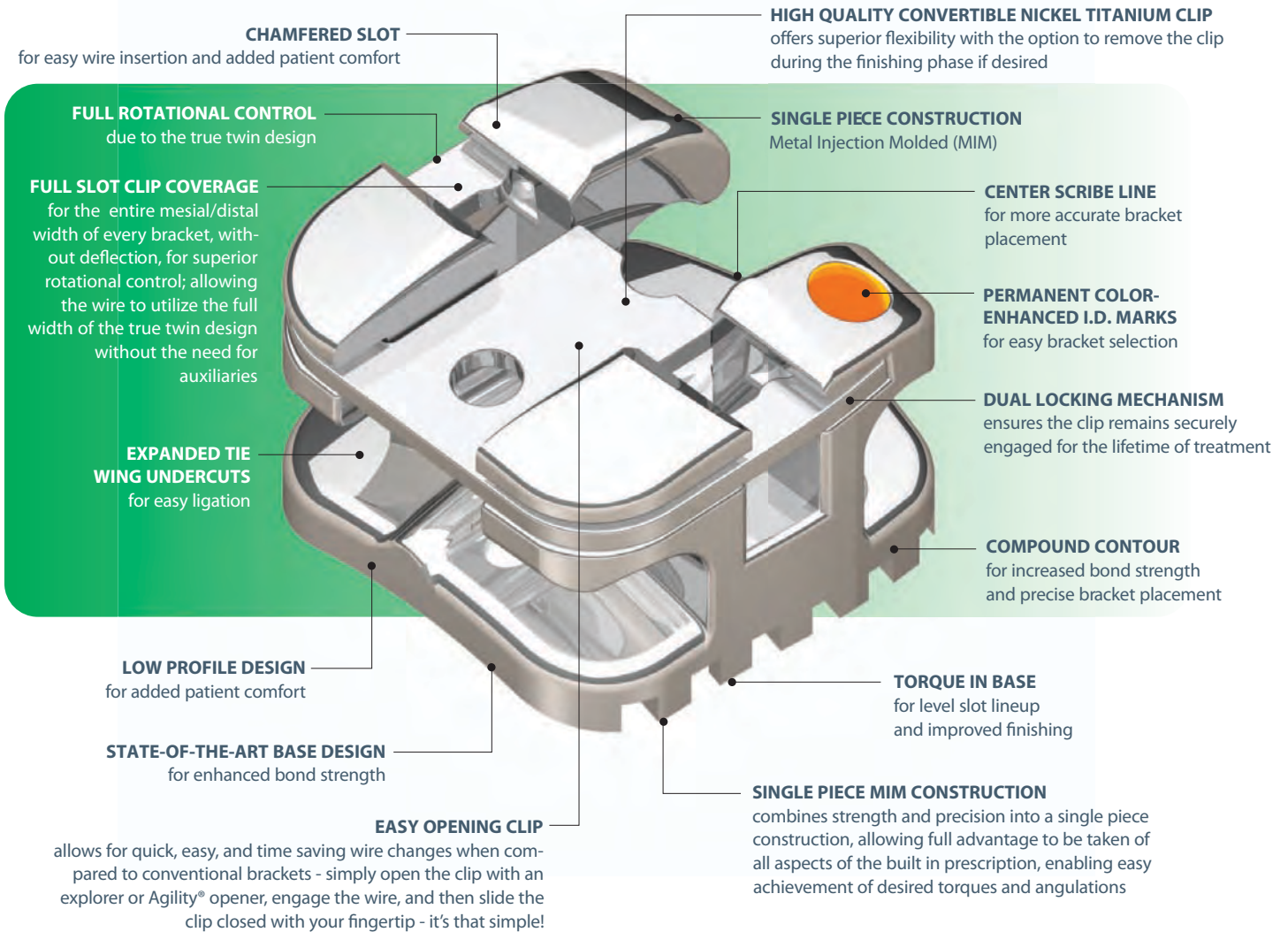

## AGILITY® SELF-LIGATING BRACKET SYSTEM



### The Agility® Opener

The new Agility® Instrument makes opening the bracket even easier.

#### Agility® Opener

Each

ISP-001

### Recommended Opening Technique - Agility® Opener

Opening the clip of the Agility® bracket is a snap! The first “click” you hear will be the clip disengaging from the top lock, and the second “click,” assures you the clip is fully open.



Simply insert the round engagement pin, located on the beveled edge of the opener, into the lumen on the clip.



Rotate the opener until the side of the beveled edge contacts the tip of the tie wing, making sure the pin stays in the lumen.



Continue to rotate the opener, using the tie wing as a leverage point, until the clip disengages. Then pull the clip towards the incisal until the clip is fully open.

### Alternate Opening Techniques

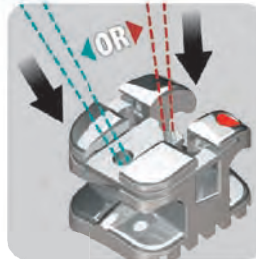

Place the tip of an explorer **1** into the clip's easily accessible circular opening or **2** at the end of the clip's alignment guide.

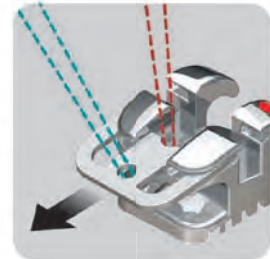

**1** or **2** Pull the explorer towards the incisal to open the clip.

### Optional Convertible Clip

The clips can be easily removed during the finishing phase, allowing the use of ligatures to secure the archwire into the slot.

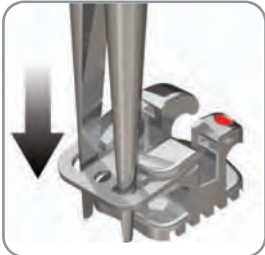

To convert, simply insert the ends of a tweezer between the mesial/distal grooves.

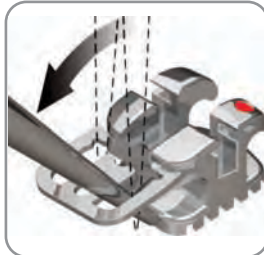

Rotate the tweezer towards the incisal in a 45° motion, gently easing the clip open.



### Closing Technique

Closing the Agility® clip is even easier.

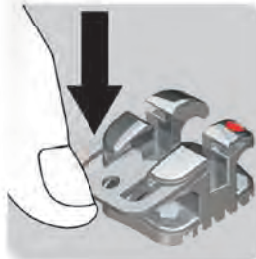

Using a utility plier, a tweezer, or even your own fingertip, gently apply pressure to the bottom lock, gently apply pressure to the occlusal side of the clip to slide closed.



When the clip begins to close, it will “click” once as it disengages from the bottom lock, and will then “click” a second time to indicate it is fully closed.

# AGILITY® SELF-LIGATING BRACKET SYSTEM

## Roth® Prescription

### Maxillary

Tooth	Torque	Angle	Rotation	M/D	R/L	ID	Anchor-Lock Pad	
							.018	.022
Central	12°	5°	0°	3.5 mm	R	●	15-U1-8R	15-U1-2R
					L	●	15-U1-8L	15-U1-2L
Lateral	8°	9°	0°	3.0 mm	R	○	15-U2-8R	15-U2-2R
					L	○	15-U2-8L	15-U2-2L
Cuspid (without Hook)	0°	11°	0°	3.3mm	R	●	15-U3-8R	15-U3-2R
					L	●	15-U3-8L	15-U3-2L
Cuspid Hk (with Hook)	0°	11°	0°	3.3mm	R	●	15-U3-8RK	15-U3-2RK
					L	●	15-U3-8LK	15-U3-2LK
1 <sup>st</sup> & 2 <sup>nd</sup> Bicuspid	-7°	0°	2°	3.0 mm	R	●	15-U4-8R	15-U4-2R
					L	●	15-U4-8L	15-U4-2L
1 <sup>st</sup> & 2 <sup>nd</sup> Bicuspid Hk	-7°	0°	2°	3.0 mm	R	●	15-U4-8RK	15-U4-2RK
					L	●	15-U4-8LK	15-U4-2LK

### Mandibular

Tooth	Torque	Angle	Rotation	M/D	R/L	ID	Anchor-Lock Pad	
							.018	.022
Anterior	0°	0°	0°	2.5 mm	U	●●	15-L1-8U	15-L1-2U
Cuspid (without Hook)	-11°	5°	0°	3.0 mm	R	●	15-L3-8R	15-L3-2R
					L	●	15-L3-8L	15-L3-2L
Cuspid Hk (with Hook)	-11°	5°	0°	3.0 mm	R	●	15-L3-8RK	15-L3-2RK
					L	●	15-L3-8LK	15-L3-2LK
1 <sup>st</sup> Bicuspid	-17°	0°	4°	3.0 mm	R	●	15-L4-8R	15-L4-2R
					L	●	15-L4-8L	15-L4-2L
1 <sup>st</sup> Bicuspid Hk	-17°	0°	4°	3.0 mm	R	●	15-L4-8RK	15-L4-2RK
					L	●	15-L4-8LK	15-L4-2LK
2 <sup>nd</sup> Bicuspid	-22°	0°	4°	3.0 mm	R	●	15-L5-8R	15-L5-2R
					L	●	15-L5-8L	15-L5-2L
2 <sup>nd</sup> Bicuspid Hk	-22°	0°	4°	3.0 mm	R	●	15-L5-8RK	15-L5-2RK
					L	●	15-L5-8LK	15-L5-2LK

Full Sets - Roth® Rx	.018	.022
Upper/Lower 5x5 Hook on 3	15K-3-18-01	15K-3-22-01
Upper/Lower 5x5 Hook on 3, 4, & 5	15K-345-18-01	15K-345-22-01

Brackets are packaged with 1 case oriented in a kit box.  
 Brackets are also available as kits in bags.  
 Brackets are also available in kits of 5 or 10 cases oriented in a carousel dispenser.

Custom kits with different bracket configurations can be ordered on request.

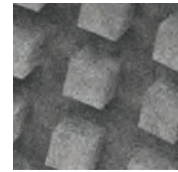

### Anchor-Lock Pad™

With retention equal to or greater than mesh bonding pads, the technologically advanced design of G&H's Anchor-Lock Pad™ bases feature miniature pylons that function like sturdy anchors embedded firmly into the adhesive.

- Technologically advanced design
- Retention equal to or greater than mesh bonding pads
- Pylons function like miniature anchors embedded firmly into the adhesive
- EDM finish on all 5 pylon surfaces to maximize bracket retention
- Pylons are designed at an acute angle relative to the torque, generating geometric undercuts when bonded

## Agility® Bracket Identification System

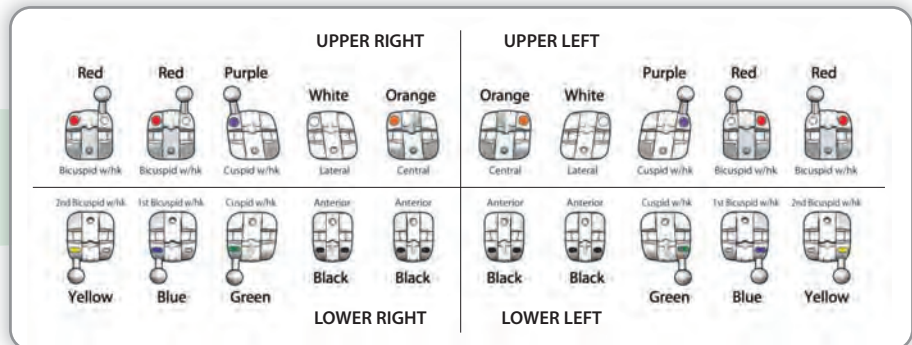

\*G&H® bracket prescriptions are not implied to be an exact version of any other system, nor do we claim any endorsement by the doctor.  
 MBT is a trademark of 3M Unitek Corporation.

## AGILITY® SELF-LIGATING BRACKET SYSTEM

### MBT® Prescription

#### Maxillary

Tooth	Torque	Angle	Rotation	M/D	R/L	ID	Anchor-Lock Pad	
							.018	.022
Central	17°	4°	0°	3.9 mm	R	● 14-U1-8R	14-U1-2R	
					L	● 14-U1-8L	14-U1-2L	
Lateral	10°	8°	0°	3.3 mm	R	○ 14-U2-8R	14-U2-2R	
					L	○ 14-U2-8L	14-U2-2L	
Cuspid (without Hook)	-7°	8°	0°	3.3 mm	R	● 14-U3-8R	14-U3-2R	
					L	● 14-U3-8L	14-U3-2L	
Cuspid Hk (with Hook)	-7°	8°	0°	3.3 mm	R	● 14-U3-8RK	14-U3-2RK	
					L	● 14-U3-8LK	14-U3-2LK	
Cuspid	0°	8°	0°	3.3 mm	R	● 14-U3-8R0	14-U3-2R0	
					L	● 14-U3-8L0	14-U3-2L0	
Cuspid Hk	0°	8°	0°	3.3 mm	R	● 14-U3-8RK0	14-U3-2RK0	
					L	● 14-U3-8LK0	14-U3-2LK0	
1 <sup>st</sup> & 2 <sup>nd</sup> Bicuspid	-7°	0°	0°	3.5 mm	U	●● 14-U4-8U	14-U4-2U	
1 <sup>st</sup> & 2 <sup>nd</sup> Bicuspid Hk	-7°	0°	0°	3.5 mm	R	● 14-U4-8RK	14-U4-2RK	
					L	● 14-U4-8LK	14-U4-2LK	

#### Mandibular

Tooth	Torque	Angle	Rotation	M/D	R/L	ID	Anchor-Lock Pad	
							.018	.022
Anterior	-6°	0°	0°	2.6 mm	U	●● 14-L1-8U	14-L1-2U	
Cuspid (without Hook)	-6°	3°	0°	3.5 mm	R	● 14-L3-8R	14-L3-2R	
					L	● 14-L3-8L	14-L3-2L	
Cuspid Hk (with Hook)	-6°	3°	0°	3.5 mm	R	● 14-L3-8RK	14-L3-2RK	
					L	● 14-L3-8LK	14-L3-2LK	
Cuspid (without Hook)	0°	3°	0°	3.5 mm	R	● 14-L3-8R0	14-L3-2R0	
					L	● 14-L3-8L0	14-L3-2L0	
Cuspid Hk (with Hook)	0°	3°	0°	3.5 mm	R	● 14-L3-8RK0	14-L3-2RK0	
					L	● 14-L3-8LK0	14-L3-2LK0	
1 <sup>st</sup> Bicuspid	-12°	0°	0°	3.5 mm	U	●● 14-L4-8U	14-L4-2U	
1 <sup>st</sup> Bicuspid Hk	-12°	0°	0°	3.5 mm	R	● 14-L4-8RK	14-L4-2RK	
					L	● 14-L4-8LK	14-L4-2LK	
2 <sup>nd</sup> Bicuspid	-17°	0°	0°	3.5 mm	U	●● 14-L5-8U	14-L5-2U	
2 <sup>nd</sup> Bicuspid Hk	-17°	0°	0°	3.5 mm	R	● 14-L5-8RK	14-L5-2RK	
					L	● 14-L5-8LK	14-L5-2LK	

#### Full Sets - MBT Rx

	.018	.022
Upper/Lower 5x5 Hook on 3	14K-3-18-01	14K-3-22-01
Upper/Lower 5x5 Hook on 3, 4, & 5	14K-345-18-01	14K-345-22-01

MBT Rx kits include 0° torque on the cuspids - custom kits available upon request.  
 Brackets are packaged with 1 case oriented in a kit box.  
 Brackets are also available as kits in bags.  
 Brackets are also available in kits of 5 or 10 cases oriented in a carousel dispenser.

Custom kits with different bracket configurations can be ordered on request.

\*G&H® bracket prescriptions are not implied to be an exact version of any other system, nor do we claim any endorsement by the doctor.  
 MBT is a trademark of 3M Unitek Corporation.

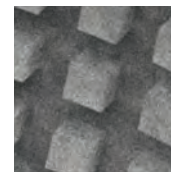

#### Anchor-Lock Pad™

With retention equal to or greater than mesh bonding pads, the technologically advanced design of G&H's Anchor-Lock Pad™ bases feature miniature pylons that function like sturdy anchors embedded firmly into the adhesive.

- Technologically advanced design
- Retention equal to or greater than mesh bonding pads
- Pylons function like miniature anchors embedded firmly into the adhesive
- EDM finish on all 5 pylon surfaces to maximize bracket retention
- Pylons are designed at an acute angle relative to the torque, generating geometric undercuts when bonded

# Metal Brackets

TOP SELLER!

# VAPOR™ CERAMIC BRACKET SYSTEM

Patent Pending

Ceramic Injection Molded – CIM Manufacturing  
Full Feature Mini Twin Design  
Made in the U.S.A. by G&H Orthodontics

## A NEARLY INVISIBLE POLYCRYSTALLINE CERAMIC BRACKET

**FULL ROTATIONAL CONTROL**  
due to the twin design

**CONTOURED TIE WINGS**  
for enhanced patient comfort

**TORQUE-IN-BASE**  
for level slot lineup  
and accurate finishing

**UNIQUE BASE DESIGN**  
for enhanced bond strength

- 100% mechanical bonds
- No chemical enhancers added
- Precise anatomical contours

**TRANSLUCENT IN APPEARANCE**  
for optimum aesthetics

**COLOR ENHANCED I.D.**  
for easy bracket selection

**COMPOUND CONTOUR BASE**

- Enhances comfort
- Reduces occlusal interference

**ROUNDED EDGES**  
at the slot entrance and exit  
for reduced friction

**PORTAL**  
for secure mechanical bonds

**EXPANDED TIE WING UNDERCUTS**  
for easy ligation

Hooks available on 3's, 4's and 5's



*"The Vapor system provides all the characteristics one would look for in a high quality ceramic bracket: esthetics, ease of bonding, smoothness and strength. Thanks to the unique portals in the base, mechanical bond strength is enhanced yet the bracket is easy to debond. It is made in the USA and is cost-effective. I can't think of anything else one could possibly ask for!"*

– Howard Fine, D.M.D., M.M.S.c



## Vapor's Revolutionary "Portal" Bonding Base\*\*

Only G&H® offers "Portal Base" Bonding Technology

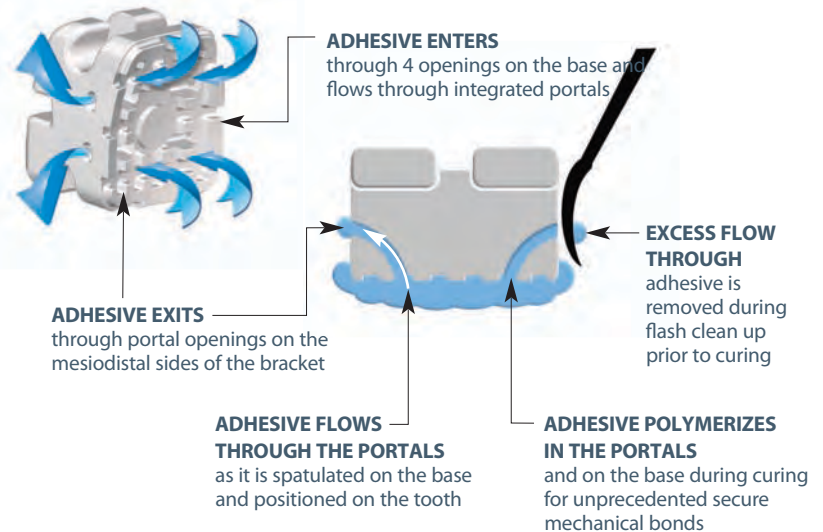

*Easy and safe debonding with the same routine procedures used with metal brackets.*

\*\*100% mechanical bonds – No chemical bond enhancers added – No special or specific adhesive necessary

\*G&H® bracket prescriptions are not implied to be an exact version of any other system, nor do we claim any endorsement by the doctor.  
MBT is a trademark of 3M Unitek Corporation.



## VAPOR CERAMIC BRACKET SYSTEM

### Roth® Prescription

#### Maxillary

Tooth	Torque	Angle	Rotation	M/D	Slot Prof.	R/L	ID	.018	.022
Central	12°	5°	0°	.150"	.044"	R	●	75-U1-8R	75-U1-2R
						L	●	75-U1-8L	75-U1-2L
Lateral	8°	9°	0°	.132"	.051"	R	○	75-U2-8R	75-U2-2R
						L	○	75-U2-8L	75-U2-2L
Cuspid Hk	0°	11°	0°	.135"	.037"	R	●	75-U3-8RK	75-U3-2RK
						L	●	75-U3-8LK	75-U3-2LK
1 <sup>st</sup> & 2 <sup>nd</sup> Bicuspid	-7°	0°	0°	.130"	.042"	U	●●	75-U4-8U	75-U4-2U
1 <sup>st</sup> & 2 <sup>nd</sup> Bicuspid Hk	-7°	0°	0°	.130"	.042"	R	●	75-U4-8RK	75-U4-2RK
						L	●	75-U4-8LK	75-U4-2LK

#### Mandibular

Tooth	Torque	Angle	Rotation	M/D	Slot Prof.	R/L	ID	.018	.022
Anterior	0°	0°	0°	.120"	.052"	U	●●	75-L1-8U	75-L1-2U
Cuspid Hk	-11°	5°	0°	.135"	.043"	R	●	75-L3-8RK	75-L3-2RK
						L	●	75-L3-8LK	75-L3-2LK
1 <sup>st</sup> Bicuspid	-17°	0°	0°	.130"	.043"	U	●●	75-L4-8U	75-L4-2U
1 <sup>st</sup> Bicuspid Hk	-17°	0°	0°	.130"	.043"	R	●	75-L4-8RK	75-L4-2RK
						L	●	75-L4-8LK	75-L4-2LK
2 <sup>nd</sup> Bicuspid	-22°	0°	0°	.130"	.043"	U	●●	75-L5-8U	75-L5-2U
2 <sup>nd</sup> Bicuspid Hk	-22°	0°	0°	.130"	.043"	R	●	75-L5-8RK	75-L5-2RK
						L	●	75-L5-8LK	75-L5-2LK

#### Full Sets - Roth® Rx

	.018	.022
Upper/Lower 5x5 Hook on 3	75K-3-18-01	75K-3-22-01
Upper/Lower 5x5 Hook on 3, 4, & 5	75K-345-18-01	75K-345-22-01

Brackets are packaged with 1 case oriented in a kit box.

Brackets are also available as kits in bags.

Brackets are also available in kits of 5 or 10 cases oriented in a carousel dispenser.

Custom kits with different bracket configurations can be ordered on request.

### VAPOR IDENTIFICATION SYSTEM

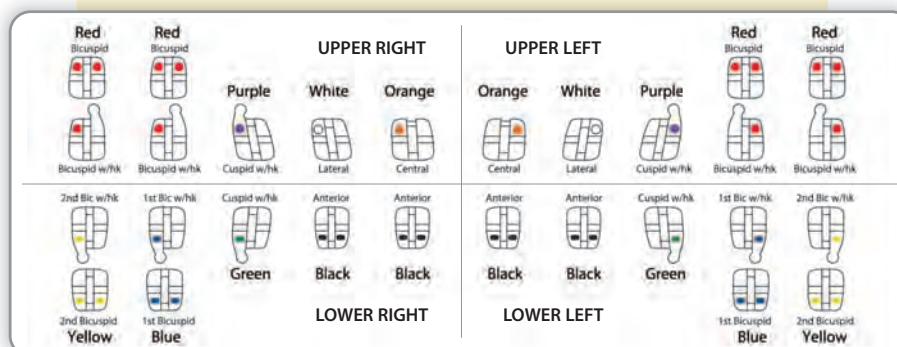

\*G&H® bracket prescriptions are not implied to be an exact version of any other system, nor do we claim any endorsement by the doctor. MBT is a trademark of 3M Unitek Corporation.

# VAPOR CERAMIC BRACKET SYSTEM

## MBT\* Prescription

### Maxillary

Tooth	Torque	Angle	Rotation	M/D	Slot Prof.	R/L	ID	.018	.022
Central	17°	4°	0°	.150"	.044"	R	●	76-U1-8R	76-U1-2R
						L	●	76-U1-8L	76-U1-2L
Lateral	10°	8°	0°	.132"	.051"	R	○	76-U2-8R	76-U2-2R
						L	○	76-U2-8L	76-U2-2L
Cuspid Hk	-7°	8°	0°	.135"	.036"	R	●	76-U3-8RK	76-U3-2RK
						L	●	76-U3-8LK	76-U3-2LK
Cuspid Hk	0°	8°	0°	.135"	.036"	R	●	76-U3-8RK0	76-U3-2RK0
						L	●	76-U3-8LK0	76-U3-2LK0
1 <sup>st</sup> & 2 <sup>nd</sup> Bicuspid	-7°	0°	0°	.130"	.042"	U	●●	76-U4-8U	76-U4-2U
1 <sup>st</sup> & 2 <sup>nd</sup> Bicuspid Hk	-7°	0°	0°	.130"	.042"	R	●	76-U4-8RK	76-U4-2RK
						L	●	76-U4-8LK	76-U4-2LK

### Mandibular

Tooth	Torque	Angle	Rotation	M/D	Slot Prof.	R/L	ID	.018	.022
Anterior	-6°	0°	0°	.120"	.052"	U	●●	76-L1-8U	76-L1-2U
Cuspid Hk	-6°	3°	0°	.135"	.043"	R	●	76-L3-8RK	76-L3-2RK
						L	●	76-L3-8LK	76-L3-2LK
Cuspid Hk	0°	3°	0°	.135"	.043"	R	●	76-L3-8RK0	76-L3-2RK0
						L	●	76-L3-8LK0	76-L3-2LK0
1 <sup>st</sup> Bicuspid	-12°	0°	0°	.130"	.042"	U	●●	76-L4-8U	76-L4-2U
1 <sup>st</sup> Bicuspid Hk	-12°	0°	0°	.130"	.042"	R	●	76-L4-8RK	76-L4-2RK
						L	●	76-L4-8LK	76-L4-2LK
2 <sup>nd</sup> Bicuspid	-17°	0°	0°	.130"	.042"	U	●●	76-L5-8U	76-L5-2U
2 <sup>nd</sup> Bicuspid Hk	-17°	0°	0°	.130"	.042"	R	●	76-L5-8RK	76-L5-2RK
						L	●	76-L5-8LK	76-L5-2LK

#### Full Sets - MBT\* Rx

	.018	.022
Upper/Lower 5x5 Hook on 3	76K-3-18-01	76K-3-22-01
Upper/Lower 5x5 Hook on 3, 4, & 5	76K-345-18-01	76K-345-22-01

MBT Rx kits include 0° torque on the cuspids - custom kits available upon request.  
 Brackets are packaged with 1 case oriented in a kit box.  
 Brackets are also available as kits in bags.  
 Brackets are also available in kits of 5 or 10 cases oriented in a carousel dispenser.  
 Custom kits with different bracket configurations can be ordered on request.



\*G&H® bracket prescriptions are not implied to be an exact version of any other system, nor do we claim any endorsement by the doctor.  
 MBT is a trademark of 3M Unitek Corporation.

## PRISM™ COMPOSITE BRACKET SYSTEM

Manufactured by G&H® Orthodontics

**TRANSLUCENT**  
for pleasing aesthetics

**PRECISION MILLED  
ARCHWIRE SLOT**  
for accurate bracket  
prescriptions

**CONTOURED  
TIE WING**  
for added  
patient comfort

**ROUNDED  
CORNERS**  
for enhanced  
patient comfort

**AMPLE TIE WING AREA**  
for easy bracket ligation

**COLOR ENHANCED I.D.**  
for easy bracket selection

**COMPOUND  
CONTOUR BASE**  
for an ideal bracket fit

**TORQUE-IN-BASE**  
for level slot lineup and  
accurate finishing

**MECHANICAL LOCK BASE with DOVETAIL GROOVES**  
for increased retention

Prism™ aesthetic brackets applied to a demonstration model.



### Prism™ Bracket Identification System

UPPER RIGHT					UPPER LEFT				
Blue	Blue	Red	Green	Orange	Orange	Green	Red	Blue	Blue
Bicuspid	Bicuspid	Cuspid	Lateral	Central	Central	Lateral	Cuspid	Bicuspid	Bicuspid
Black	Brown	Yellow	Purple	Purple	Purple	Purple	Yellow	Brown	Black
LOWER RIGHT					LOWER LEFT				
Black	Brown	Yellow	Purple	Purple	Purple	Purple	Yellow	Brown	Black
2nd Bicuspid	1st Bicuspid	Cuspid	Anterior	Anterior	Anterior	Anterior	Cuspid	1st Bicuspid	2nd Bicuspid

## PRISM™ COMPOSITE BRACKET SYSTEM

### Roth\* Prescription

#### Maxillary

Tooth	Torque	Angle	Rotation	M/D	R/L	ID	.018	.022
Central	12°	5°	0°	3.9 mm	R	●	45-U1-8R	45-U1-2R
					L	●	45-U1-8L	45-U1-2L
Lateral	8°	9°	0°	3.3 mm	R	●	45-U2-8R	45-U2-2R
					L	●	45-U2-8L	45-U2-2L
Cuspid (without Hook)	0°	11°	4°	3.3 mm	R	●	45-U3-8R	45-U3-2R
					L	●	45-U3-8L	45-U3-2L
Cuspid Hk (with Hook)	0°	11°	4°	3.3 mm	R	●	45-U3-8RK	45-U3-2RK
					L	●	45-U3-8LK	45-U3-2LK
1 <sup>st</sup> & 2 <sup>nd</sup> Bicuspid	-7°	0°	0°	3.3 mm	U	●●	45-U4-8U	45-U4-2U
1 <sup>st</sup> & 2 <sup>nd</sup> Bicuspid Hk	-7°	0°	0°	3.3 mm	U	●●	45-U4-8UK	45-U4-2UK

#### Mandibular

Tooth	Torque	Angle	Rotation	M/D	R/L	ID	.018	.022
Anterior	0°	0°	0°	2.8 mm	U	●●	45-L1-8U	45-L1-2U
Cuspid (without Hook)	-11°	5°	2°	3.3 mm	R	●	45-L3-8R	45-L3-2R
					L	●	45-L3-8L	45-L3-2L
Cuspid Hk (with Hook)	-11°	5°	2°	3.3 mm	R	●	45-L3-8RK	45-L3-2RK
					L	●	45-L3-8LK	45-L3-2LK
1 <sup>st</sup> Bicuspid	-17°	0°	0°	3.3 mm	U	●●	45-L4-8U	45-L4-2U
1 <sup>st</sup> Bicuspid Hk	-17°	0°	0°	3.3 mm	U	●●	45-L4-8UK	45-L4-2UK
2 <sup>nd</sup> Bicuspid	-22°	0°	0°	3.3 mm	U	●●	45-L5-8U	45-L5-2U
2 <sup>nd</sup> Bicuspid Hk	-22°	0°	0°	3.3 mm	U	●●	45-L5-8UK	45-L5-2UK

#### Full Sets - Roth\* Rx

	.018	.022
Upper/Lower 5x5 Hook on 3	45K-3-18-01	45K-3-22-01
Upper/Lower 5x5 Hook on 3, 4, & 5	45K-345-18-01	45K-345-22-01

### Edgewise Prescription

#### Maxillary & Mandibular

Tooth	Torque	Angle	Rotation	M/D	R/L	ID	.018	.022
Central	0°	0°	0°	3.9 mm	U	--	47-CENT-18	47-CENT-22
Lateral	0°	0°	0°	3.3 mm	U	--	47-LAT-18	47-LAT-22
Cuspid	0°	0°	0°	3.3 mm	U	--	47-CUSP-18	47-CUSP-22
Bicuspid	0°	0°	0°	3.3 mm	U	--	47-BIC-18	47-BIC-22
Lower Anterior	0°	0°	0°	2.8 mm	U	--	47-ANT-18	47-ANT-22

#### Full Sets - Edgewise Rx

	.018	.022
Upper/Lower 5x5 No Hooks	47K-EDGE-18-01	47K-EDGE-22-01

Brackets are packaged with 1 case oriented in a kit box.

Brackets are also available as kits in bags.

Brackets are also available in kits of 5 or 10 cases oriented in a carousel dispenser.

Custom kits with different bracket configurations can be ordered on request.

\*G&H® bracket prescriptions are not implied to be an exact version of any other system, nor do we claim any endorsement by the doctor. MBT is a trademark of 3M Unitek Corporation.

## PRISM™ COMPOSITE BRACKET SYSTEM

### MBT\* Prescription

#### Maxillary

Tooth	Torque	Angle	Rotation	M/D	R/L	ID	.018	.022
Central	17°	4°	0°	3.9 mm	R	●	46-U1-8R	46-U1-2R
					L	●	46-U1-8L	46-U1-2L
Lateral	10°	8°	0°	3.3 mm	R	●	46-U2-8R	46-U2-2R
					L	●	46-U2-8L	46-U2-2L
Cuspid (without Hook)	-7°	8°	0°	3.3 mm	R	●	46-U3-8R	46-U3-2R
					L	●	46-U3-8L	46-U3-2L
Cuspid Hk (with Hook)	0°	8°	0°	3.3 mm	R	●	46-U3-8RK	46-U3-2RK
					L	●	46-U3-8LK	46-U3-2LK
1 <sup>st</sup> & 2 <sup>nd</sup> Bicuspid	-7°	0°	0°	3.3 mm	U	●●	46-U4-8U	46-U4-2U
1 <sup>st</sup> & 2 <sup>nd</sup> Bicuspid Hk	-7°	0°	0°	3.3 mm	U	●●	46-U4-8UK	46-U4-2UK

#### Mandibular

Tooth	Torque	Angle	Rotation	M/D	R/L	ID	.018	.022
Anterior	-6°	0°	0°	2.8 mm	U	●●	46-L1-8U	46-L1-2U
Cuspid (without Hook)	-6°	3°	0°	3.3 mm	R	●	46-L3-8R	46-L3-2R
					L	●	46-L3-8L	46-L3-2L
Cuspid Hk (with Hook)	0°	3°	0°	3.3 mm	R	●	46-L3-8RK	46-L3-2RK
					L	●	46-L3-8LK	46-L3-2LK
1 <sup>st</sup> Bicuspid	-12°	2°	0°	3.3 mm	R	●	46-L4-8R	46-L4-2R
					L	●	46-L4-8L	46-L4-2L
1 <sup>st</sup> Bicuspid Hk	-12°	2°	0°	3.3 mm	R	●	46-L4-8RK	46-L4-2RK
					L	●	46-L4-8LK	46-L4-2LK
2 <sup>nd</sup> Bicuspid	-17°	2°	0°	3.3 mm	R	●	46-L5-8R	46-L5-2R
					L	●	46-L5-8L	46-L5-2L
2 <sup>nd</sup> Bicuspid Hk	-17°	2°	0°	3.3 mm	R	●	46-L5-8RK	46-L5-2RK
					L	●	46-L5-8LK	46-L5-2LK

Full Sets - MBT* Rx	.018	.022
Upper/Lower 5x5 Hook on 3	46K-3-18-01	46K-3-22-01
Upper/Lower 5x5 Hook on 3, 4, & 5	46K-345-18-01	46K-345-22-01

MBT Rx kits include 0° torque on the cuspids - custom kits available upon request.

Brackets are packaged with 1 case oriented in a kit box.

Brackets are also available as kits in bags.

Brackets are also available in kits of 5 or 10 cases oriented in a carousel dispenser.

Custom kits with different bracket configurations can be ordered on request.

\*G&H® bracket prescriptions are not implied to be an exact version of any other system, nor do we claim any endorsement by the doctor. MBT is a trademark of 3M Unitek Corporation.

Orthodontists requested innovative technology and sleek, stylish comfort. We delivered.

# VIPER™

## LOW PROFILE BUCCAL TUBES

Manufactured by G&H® Orthodontics

### VIPER™ Low Profile Buccal Tubes

**You spoke. We listened.** Sleek and stylish, G&H's Viper™ buccal tube incorporates the latest design technology with a growing industry demand for comfortable, easy-to-use appliances that simplify treatment and reduce valuable chair time.

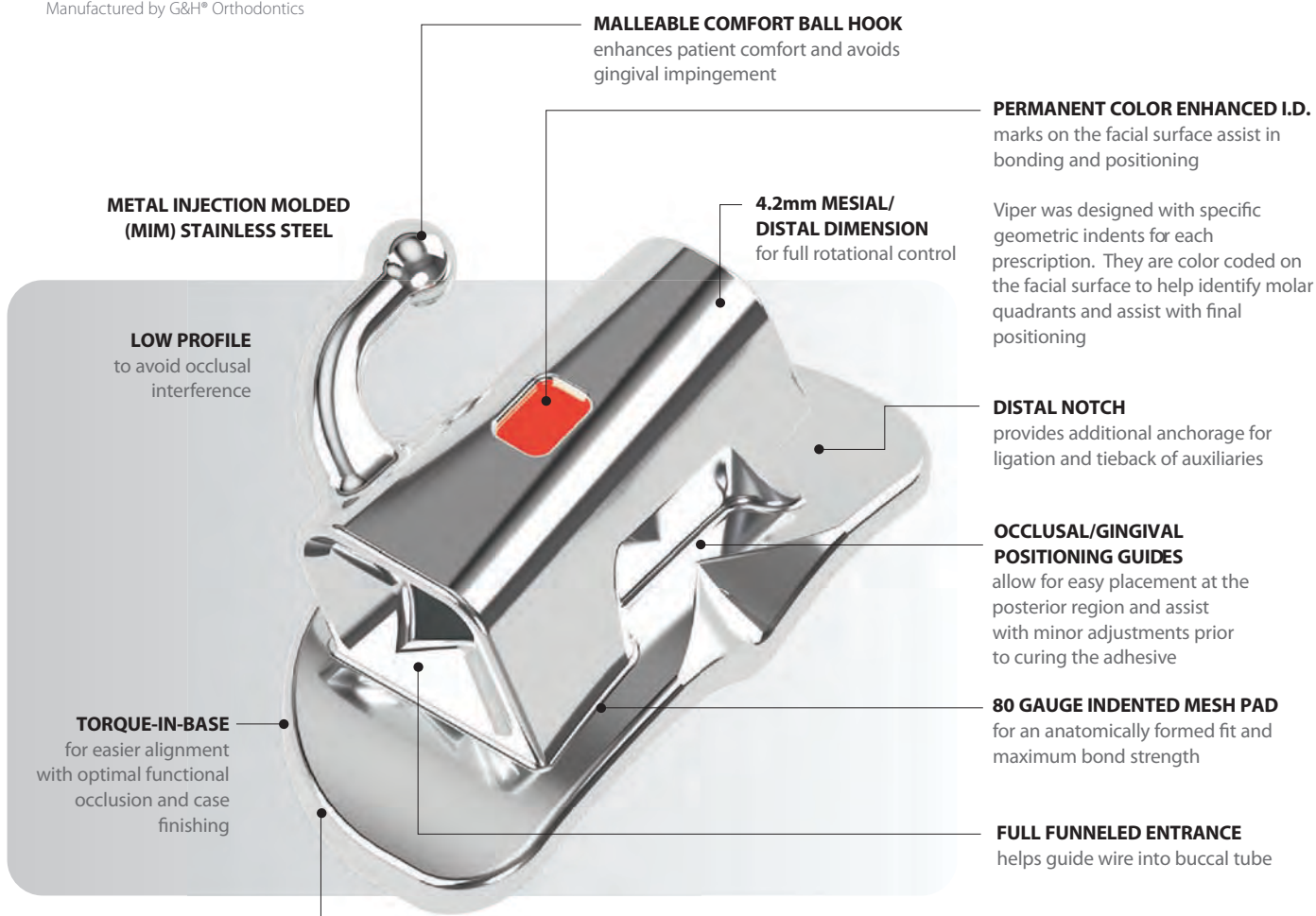

### Confidence is in the Design

Achieving stronger, more consistent bonds in every case is made possible by unique pad designs that accommodate a wide array of treatment needs.

#### Developmental Indent

Because precise positioning is critical in establishing an effective treatment and avoiding occlusal interference with opposing teeth, we designed our bond pads with pronounced developmental indents to make locating the optimal bonding position a snap.

#### Unique Pad Design

A uniquely crafted distal gingival cutout enables the bonding of partially erupted molars without sacrificing the size and strength of the pad.

#### Molded Compound Contour Base

Anatomically conforms to the tooth and provides proper fit and appliance expression.

#### 80 Gauge Mesh

Featuring an 80 gauge mesh base in three different pad configurations, our direct bond tubes are sure to meet all of your treatment needs.

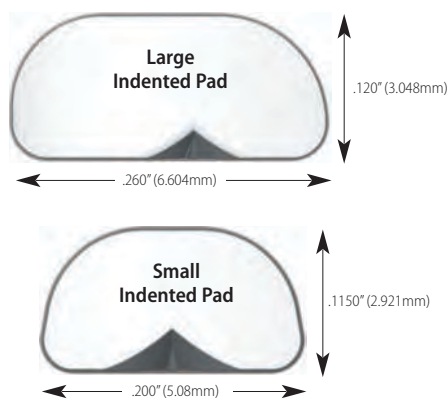

## VIPER™ NON-CONVERTIBLE TUBES



G&H® has eliminated the frustration and wasted time of threading a wire into the small opening of traditional buccal tubes. The Viper's trumpeted entrance facilitates easy wire insertion. Wires are guided easily and gently into Viper's expansive entrance, simplifying arch wire adjustments and saving valuable chair time.



### Custom Welding

Viper™ buccal tubes are also available custom welded directly onto bands to meet your specific requirements and provide added convenience. With consistent quality products and custom applications that you can count on every time, G&H® is here to help your practice thrive.

**No charge for custom welding on G&H bands.** (Bands are on pages 29-33)

### Single Non-Convertible

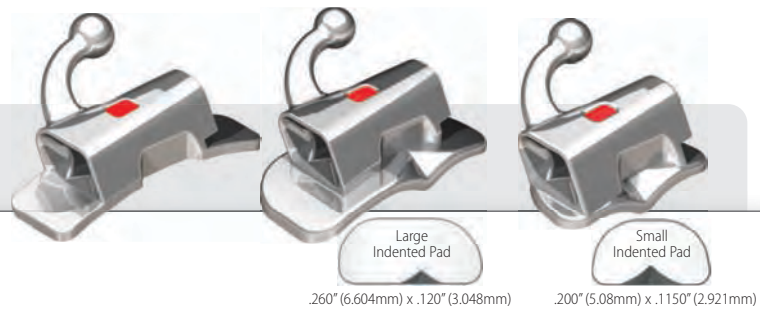

### Maxillary 1<sup>st</sup> & 2<sup>nd</sup> Molar

Torque	Offset	Rx	M/D	R/L	ID	Weldable		Bondable			
						.018	.022	.018	.022	.018	.022
0° (W/O Distal Extension)	0°	STD	4.2 mm	R	◆	NS3-821	NS3-221	NS3B-821E	NS3B-221E	NS3B-821I	NS3B-221I
				L	◆	NS3-822	NS3-222	NS3B-822E	NS3B-222E	NS3B-822I	NS3B-222I
-10° (W/Distal Extension)	8°	Roth*	4.2 mm	R	●	NS3-825	NS3-225	NS3B-825E	NS3B-225E	NS3B-825I	NS3B-225I
				L	●	NS3-826	NS3-226	NS3B-826E	NS3B-226E	NS3B-826I	NS3B-226I
-14° (W/Distal Extension)	10°	MBT*	4.2 mm	R	●	NS3-833	NS3-233	NS3B-833E	NS3B-233E	NS3B-833I	NS3B-233I
				L	●	NS3-834	NS3-234	NS3B-834E	NS3B-234E	NS3B-834I	NS3B-234I

### Mandibular 1<sup>st</sup> & 2<sup>nd</sup> Molar

Torque	Offset	Rx	M/D	R/L	ID	Weldable		Bondable			
						.018	.022	.018	.022	.018	.022
0° (W/O Distal Extension)	0°	STD	4.2 mm	R	◆	NS3-822	NS3-222	NS3B-822E	NS3B-222E	NS3B-822I	NS3B-222I
				L	◆	NS3-821	NS3-221	NS3B-821E	NS3B-221E	NS3B-821I	NS3B-221I
-25° (W/Distal Extension)	5°	Roth*	4.2 mm	R	■	NS3-827	NS3-227	NS3B-827E	NS3B-227E	NS3B-827I	NS3B-227I
				L	■	NS3-828	NS3-228	NS3B-828E	NS3B-228E	NS3B-828I	NS3B-228I
-20° (W/O Distal Extension)	0°	MBT*	4.2 mm	R	▲	NS3-809	NS3-209	NS3B-809E	NS3B-209E	NS3B-809I	NS3B-209I
				L	▲	NS3-810	NS3-210	NS3B-810E	NS3B-210E	NS3B-810I	NS3B-210I

\*G&H® bracket prescriptions are not implied to be an exact version of any other system, nor do we claim any endorsement by the doctor. MBT is a trademark of 3M Unitek Corporation.

## VIPER™ NON-CONVERTIBLE TUBES

### Viper™ Low Profile Mini 2<sup>nd</sup> Tube

Specially designed for partially erupted 2<sup>nd</sup> Molars.

Viper™ Mini Low Profile Buccal Tubes incorporate all the great features of our standard Viper™ series, but in a small feature-rich design that allows for earlier bonding of partially erupted second molars. The Viper's trumpeted entrance facilitates easy wire insertion. Wires are guided easily and gently into Viper's expansive entrance, simplifying archwire adjustments and saving valuable chair time. Bonds with less effort by the clinician and less soft tissue trauma to the patient.



Specially designed for partially erupted 2<sup>nd</sup> Molars

- Single piece construction
- 2.5mm mesiodistal length

#### Maxillary & Mandibular 2<sup>nd</sup> Molar

Torque	Offset	M/D	R/L	ID	.018	.022
0°	0°	2.5 mm	UR/LL	◆	NS4B-821	NS4B-221
			UL/LR	◆	NS4B-822	NS4B-222
-10°	0°	2.5 mm	UR	●	NS4B-831	NS4B-231
			UL	●	NS4B-832	NS4B-232
-14°	0°	2.5 mm	UR/LL	●	NS4B-835	NS4B-235
			UL/LR	●	NS4B-836	NS4B-236
-25°	0°	2.5 mm	LR	■	NS4B-833	NS4B-233
			LL	■	NS4B-834	NS4B-234

\*G&H® bracket prescriptions are not implied to be an exact version of any other system, nor do we claim any endorsement by the doctor.  
MBT is a trademark of 3M Unitek Corporation.



## VIPER™ CONVERTIBLE TUBES

# VIPER™ CV

## LOW PROFILE BUCCAL TUBES

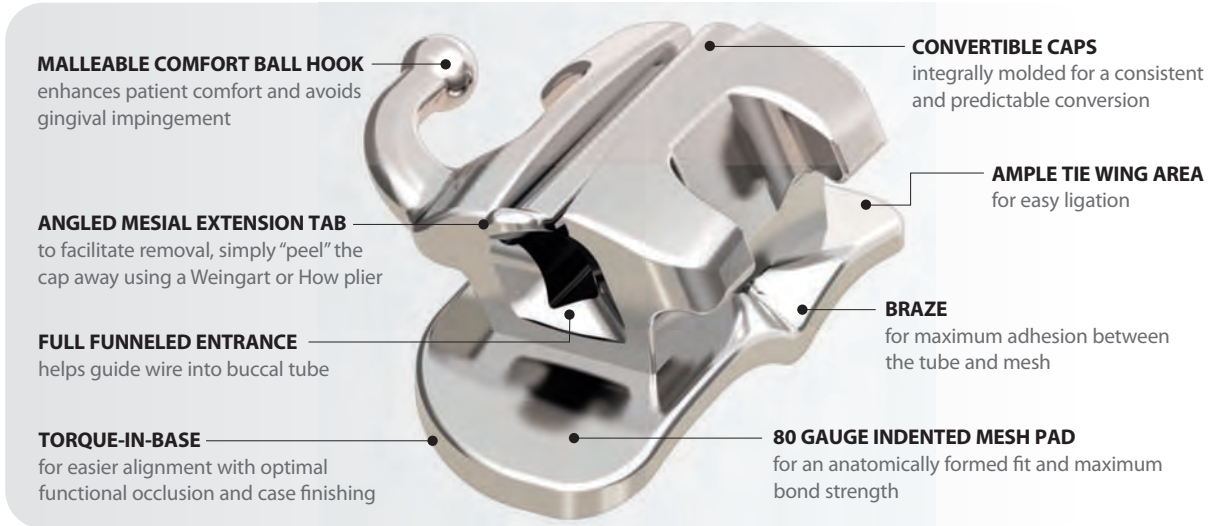

**MALLEABLE COMFORT BALL HOOK**  
enhances patient comfort and avoids gingival impingement

**ANGLED MESIAL EXTENSION TAB**  
to facilitate removal, simply “peel” the cap away using a Weingart or How plier

**FULL FUNNELED ENTRANCE**  
helps guide wire into buccal tube

**TORQUE-IN-BASE**  
for easier alignment with optimal functional occlusion and case finishing

**CONVERTIBLE CAPS**  
integrally molded for a consistent and predictable conversion

**AMPLE TIE WING AREA**  
for easy ligation

**BRAZE**  
for maximum adhesion between the tube and mesh

**80 GAUGE INDENTED MESH PAD**  
for an anatomically formed fit and maximum bond strength

**METAL INJECTION MOLDED (MIM) STAINLESS STEEL**

### Single Convertible



### Maxillary 1<sup>st</sup> Molar

Torque	Offset	Rx	M/D	R/L	Weldable		Bondable			
					.018	.022	.018	.022	.018	.022
-10°	8°	Roth*	4.2 mm	R	CS3-805	CS3-205	CS3B-805E	CS3B-205E	CS3B-805I	CS3B-205I
				L	CS3-806	CS3-206	CS3B-806E	CS3B-206E	CS3B-806I	CS3B-206I
-14°	10°	MBT*	4.2 mm	R	CS3-813	CS3-213	CS3B-813E	CS3B-213E	CS3B-813I	CS3B-213I
				L	CS3-814	CS3-214	CS3B-814E	CS3B-214E	CS3B-814I	CS3B-214I

### Mandibular 1<sup>st</sup> Molar

Torque	Offset	Rx	M/D	R/L	Weldable		Bondable			
					.018	.022	.018	.022	.018	.022
-25°	5°	Roth*	4.2 mm	R	CS3-807	CS3-207	CS3B-807E	CS3B-207E	CS3B-807I	CS3B-207I
				L	CS3-808	CS3-208	CS3B-808E	CS3B-208E	CS3B-808I	CS3B-208I
-20°	0°	MBT*	4.2 mm	R	CS3-815	CS3-215	CS3B-815E	CS3B-215E	CS3B-815I	CS3B-215I
				L	CS3-816	CS3-216	CS3B-816E	CS3B-216E	CS3B-816I	CS3B-216I

\*G&H® bracket prescriptions are not implied to be an exact version of any other system, nor do we claim any endorsement by the doctor. MBT is a trademark of 3M Unitek Corporation.

**VIPER™ COMBINATION CONVERTIBLE TUBES**

**VIPER™ CV**  
COMBINATION  
BUCCAL TUBES

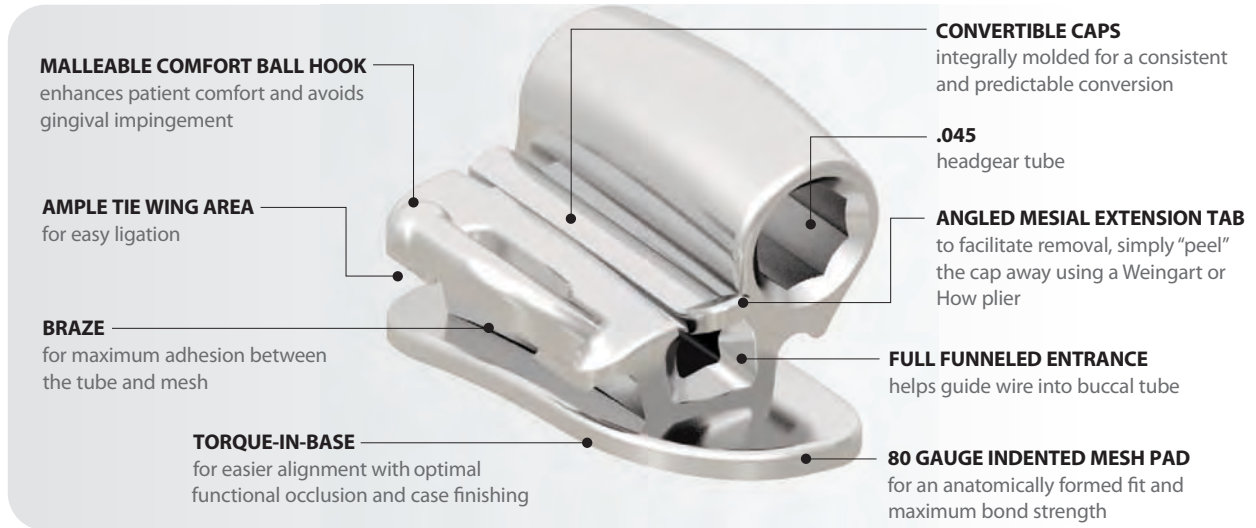

**METAL INJECTION MOLDED (MIM) STAINLESS STEEL**

**Combination  
Convertible**



**Maxillary 1<sup>st</sup> Molar**

Torque	Offset	Rx	M/D	R/L	Weldable		Bondable	
					.018	.022	.018	.022
-10°	8°	Roth*	4.2 mm	R	CC3-805	CC3-205	CC3B-805E	CC3B-205E
				L	CC3-806	CC3-206	CC3B-806E	CC3B-206E
-14°	10°	MBT*	4.2 mm	R	CC3-817	CC3-217	CC3B-817E	CC3B-217E
				L	CC3-818	CC3-218	CC3B-818E	CC3B-218E

\*G&H® bracket prescriptions are not implied to be an exact version of any other system, nor do we claim any endorsement by the doctor. MBT is a trademark of 3M Unitek Corporation.

## MAGNUM™ BUCCAL TUBES

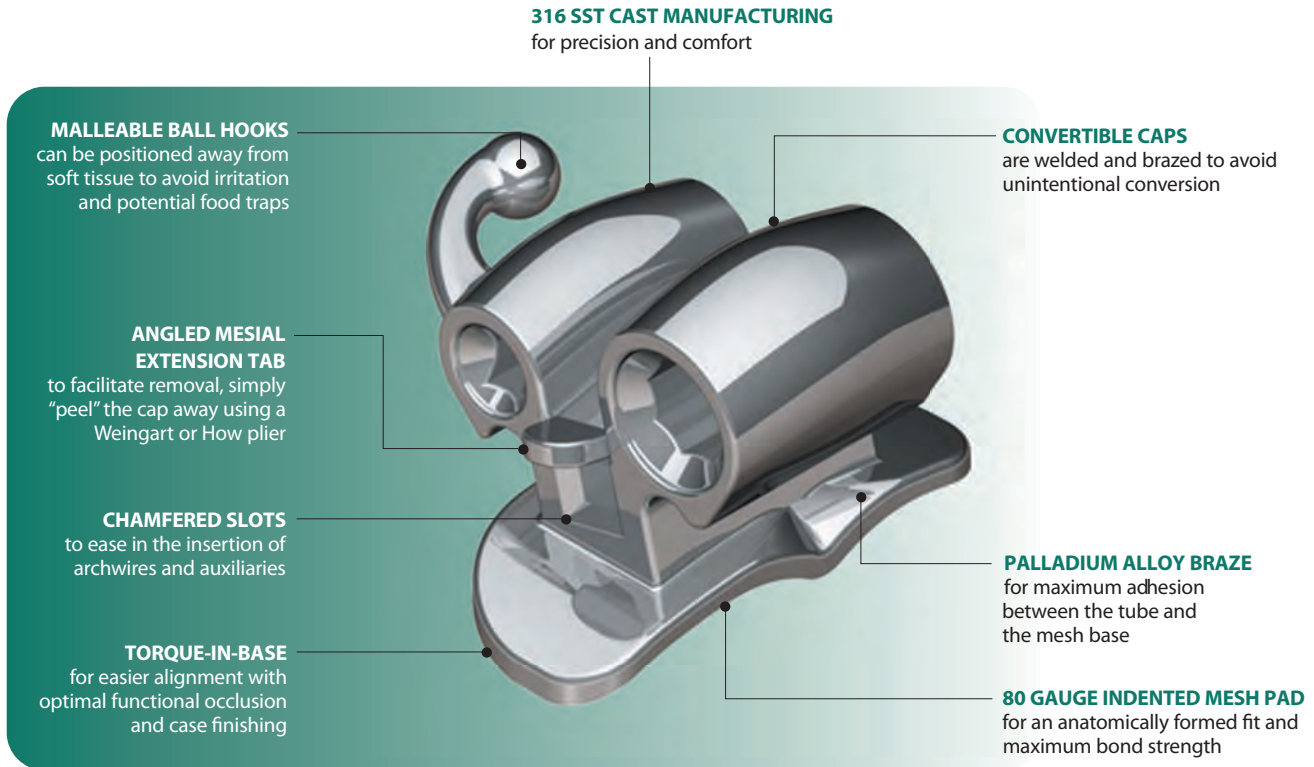

### Available Three Ways: Bondable, Weldable or Pre-Welded

All buccal tubes offered by G&H® are available with direct bond bases, weldable for welding your own assemblies, or pre-welded directly on bands to meet your specific needs and to provide added convenience. With consistent quality products and custom applications that you can count on every time, G&H® is here to help your practice thrive.

G&H®'s Magnum™ Buccal Tube line offers miniaturized cast buccal tubes with rounded surfaces for exceptional patient comfort and acceptance.

### Comfort is in the Design

G&H®'s advanced design and manufacturing technologies ensure the maximum strength of our small, precision tubes for increased clinical efficiency and patient comfort. Both occlusal interference and gingival impingement are reduced, and hygiene is improved. All convertible tubes incorporate a true "twin" bracket tie wing design to aid in ligation. Our combination tubes also incorporate a distinctive tie wing design for secure ligation following archwire slot conversion, and are offset from the gingival to avoid tissue impingement.

## MAGNUM™ CONVERTIBLE TUBES



### Triple Convertible HG Occlusal

Large Indented Pad  
.260" (6.604mm) x .120" (3.048mm)

#### Maxillary 1<sup>st</sup> Molar

Torque	Offset	Rx	HG I.D.	Aux. Tube	M/D	R/L	Weldable		Bondable	
							.018	.022	.018	.022
-10°	8°	Roth*	.045" Occl.	.018 / 0°T	3.5 mm	R	CT1-805	CT1-205	CT1B-805E	CT1B-205E
						L	CT1-806	CT1-206	CT1B-806E	CT1B-206E
-10°	8°	Roth*	.051" Occl.	.018 / 0°T	3.5 mm	R	CT1-855	CT1-255	--	--
						L	CT1-856	CT1-256	--	--
-14°	10°	MBT*	.045" Occl.	.018 / 0°T	3.5 mm	R	CT1-807	CT1-207	CT1B-807E	CT1B-207E
						L	CT1-808	CT1-208	CT1B-808E	CT1B-208E
-14°	10°	MBT*	.051" Occl.	.018 / 0°T	3.5 mm	R	CT1-857	CT1-257	--	--
						L	CT1-858	CT1-258	--	--

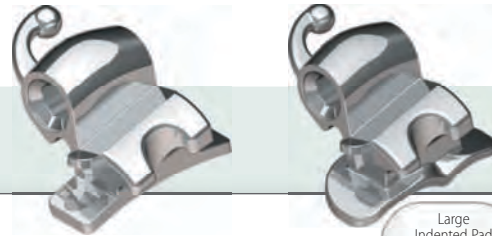

Large Indented Pad  
.260" (6.604mm) x .120" (3.048mm)

### Combination Convertible HG Gingival

#### Maxillary 1<sup>st</sup> Molar

Torque	Offset	Rx	HG I.D.	Aux. Tube	M/D	R/L	Weldable		Bondable	
							.018	.022	.018	.022
-10°	8°	Roth*	.045" Ging.	--	3.5 mm	R	CC-815	CC-215	CCB-815E	CCB-215E
						L	CC-816	CC-216	CCB-816E	CCB-216E
-10°	8°	Roth*	.051" Ging.	--	3.5 mm	R	CC-855	CC-255	--	--
						L	CC-856	CC-256	--	--
-14°	10°	MBT*	.045" Ging.	--	3.5 mm	R	CC1-817	CC1-217	CC1B-817E	CC1B-217E
						L	CC1-818	CC1-218	CC1B-818E	CC1B-218E
-14°	10°	MBT*	.051" Ging.	--	3.5 mm	R	CC1-857	CC1-257	--	--
						L	CC1-858	CC1-258	--	--

#### Mandibular 1<sup>st</sup> Molar

Torque	Offset	Rx	HG I.D.	Aux. Tube	M/D	R/L	Weldable		Bondable	
							.018	.022	.018	.022
-25°	5°	Roth*	.045" Ging.	--	3.5 mm	R	CL1-807	CL1-207	CL1B-807E	CL1B-207E
						L	CL1-808	CL1-208	CL1B-808E	CL1B-208E

\*G&H\* bracket prescriptions are not implied to be an exact version of any other system, nor do we claim any endorsement by the doctor.  
MBT is a trademark of 3M Unitek Corporation.

## MAGNUM™ CONVERTIBLE TUBES

### Double Convertible

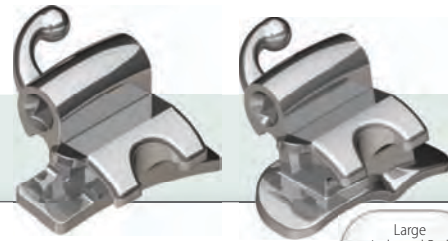

Large Indented Pad

.260" (6.604mm) x .120" (3.048mm)

### Maxillary 1<sup>st</sup> Molar

Torque	Offset	Rx	HG I.D.	Aux. Tube	M/D	R/L	Weldable		Bondable	
							.018	.022	.018	.022
-10°	8°	Roth*	--	.018 / 0°T	3.5 mm	R	CD1-805	CD1-205	CD1B-805E	CD1B-205E
						L	CD1-806	CD1-206	CD1B-806E	CD1B-206E

### Mandibular 1<sup>st</sup> Molar

Torque	Offset	Rx	HG I.D.	Aux. Tube	M/D	R/L	Weldable		Bondable	
							.018	.022	.018	.022
-25°	5°	Roth*	--	.018 / 0°T	3.5 mm	R	CD1-807	CD1-207	CD1B-807E	CD1B-207E
						L	CD1-808	CD1-208	CD1B-808E	CD1B-208E
-20°	0°	MBT*	--	.018 / 0°T	3.5 mm	R	CD1-809	CD1-209	CD1B-809E	CD1B-209E
						L	CD1-810	CD1-210	CD1B-810E	CD1B-210E

## MAGNUM™ NON-CONVERTIBLE TUBES

### Combination Non-Convertible HG Occlusal



Large Indented Pad

.260" (6.604mm) x .120" (3.048mm)

### Maxillary 1<sup>st</sup> Molar

Torque	Offset	Rx	HG I.D.	M/D	R/L	Weldable		Bondable	
						.018	.022	.018	.022
0°	0°	--	.045" Occl.	3.5 mm	R	NC1-821	NC1-221	NC1B-821E	NC1B-221E
					L	NC1-822	NC1-222	NC1B-822E	NC1B-222E
0°	0°	--	.051" Occl.	3.5 mm	R	NC1-851	NC1-251	--	--
					L	NC1-852	NC1-252	--	--
0°	8°	--	.045" Occl.	3.5 mm	R	NC1-823	NC1-223	--	--
					L	NC1-824	NC1-224	--	--
0°	8°	--	.051" Occl.	3.5 mm	R	NC1-853	NC1-253	--	--
					L	NC1-854	NC1-254	--	--
-10°	8°	Roth*	.045" Occl.	3.5 mm	R	NC1-825	NC1-225	NC1B-825E	NC1B-225E
					L	NC1-826	NC1-226	NC1B-826E	NC1B-226E
-10°	8°	Roth*	.051" Occl.	3.5 mm	R	NC1-855	NC1-255	--	--
					L	NC1-856	NC1-256	--	--
-14°	10°	MBT*	.045" Occl.	3.5 mm	R	NC1-827	NC1-227	NC1B-827E	NC1B-227E
					L	NC1-828	NC1-228	NC1B-828E	NC1B-228E
-14°	10°	MBT*	.051" Occl.	3.5 mm	R	NC1-857	NC1-257	--	--
					L	NC1-858	NC1-258	--	--

\*G&H® bracket prescriptions are not implied to be an exact version of any other system, nor do we claim any endorsement by the doctor. MBT is a trademark of 3M Unitek Corporation.

## MAGNUM™ NON-CONVERTIBLE TUBES

### Ricketts® Triple Non-Convertible HG Occlusal

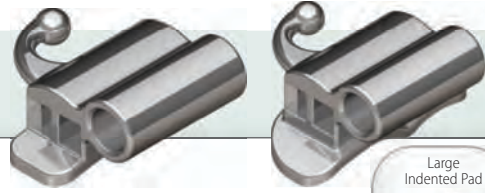

Large Indented Pad

.260" (6.604mm) x .120" (3.048mm)

#### Maxillary 1<sup>st</sup> Molar

Torque	Offset	Rx	HG I.D.	M/D	R/L	Weldable		Bondable	
						.018	.022	.018	.022
0°	0°	--	.045" Occl.	3.5 mm	R	NRT1-821	--	NRT1B-821E	--
					L	NRT1-822	--	NRT1B-822E	--

### Ricketts® Double Non-Convertible w/Aux. Hk

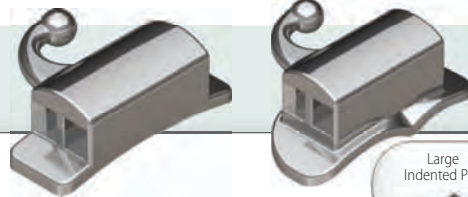

Large Indented Pad

.260" (6.604mm) x .120" (3.048mm)

#### Maxillary 1<sup>st</sup> Molar

Torque	Offset	Rx	HG I.D.	M/D	R/L	Weldable		Bondable	
						.018	.022	.018	.022
0°	0°	--	--	3.5 mm	UL/LR	NRD1-821	--	NRD1B-821E	--
					UR/LL	NRD1-822	--	NRD1B-822E	--

### Ricketts® Double Non-Convertible w/Ball Hk

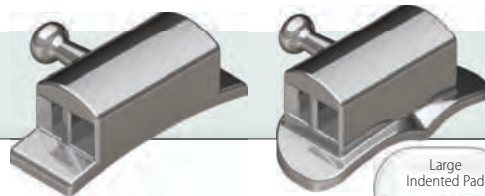

Large Indented Pad

.260" (6.604mm) x .120" (3.048mm)

#### Maxillary and/or Mandibular 1<sup>st</sup> Molar

Torque	Offset	Rx	HG I.D.	M/D	R/L	Weldable		Bondable	
						.018	.022	.018	.022
0°	0°	--	--	3.5 mm	UL/LR	NRD1-819	--	NRD1B-819E	--
					UR/LL	NRD1-820	--	NRD1B-820E	--

\*G&H® bracket prescriptions are not implied to be an exact version of any other system, nor do we claim any endorsement by the doctor.  
MBT is a trademark of 3M Unitek Corporation.

## Providing a secure fit you can count on!

**Precision-shaped tooth anatomy for a tight, secure fit and excellent retention, time after time.**

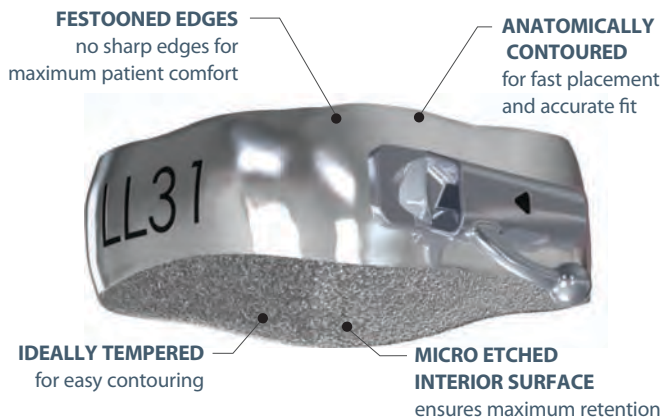

### FEATURES INCLUDE:

- Precision-shaped tooth anatomy for a tight, secure fit with excellent retention. Our distinct right and left anatomy is completely proportioned in all planes and for each band size.
- Stainless steel that exhibits properties of “hardness” for strength to avoid wall collapse when fitting, yet is malleable enough for “snap” fitting that requires little or no burnishing.
- Increased buccal height for greater flexibility in the placement and positioning of buccal tubes and lingual attachments.
- Interiors are micro-etched to provide a rough ended surface for increased bond strength.
- Permanently etched using an Electro Chemical Etching process for easy permanent identification.
- 36 upper and lower sizes graduated in even, closely spaced increments for improved fit. Saturn Bands are available in 36 sizes (full-size increments) and Titan Bands are available in 30 sizes (half-size increments).

Whether you are upgrading from your current band system or are just starting out, G&H has a band system to meet your specifications. Manufactured under stringent quality control measures, you can count on Titan and Saturn Anatomical Molar Band Systems to meet the demands of your orthodontic practice.

### FREE! PREWELDING SERVICE\*

Ordering bands with attachments can be a time consuming process, not to mention the time and expertise required to weld the attachment. G&H® offers complimentary welding with all of our appliances.

When we receive an order, the weld specifications are kept on file so reorders utilizing the same appliances and weld specifications can be simplified by asking us to duplicate your last order. We can even provide you with our order form to further facilitate processing.

G&H® also offers “custom” welding to meet specific prescriptions. However, you will find that our standard weld specifications will satisfy most prescriptions. Additionally, we will weld appliances from other companies at a nominal charge, but the appliances and weld specifications must be submitted when the order is placed.

Also available –

**Band Seating Instruments -** (See page 101)



### Plastic Band Organizer with Lid

Plastic band organizers are designed for proper band storage and will fit most band cabinets. Included with kit purchase.

Titan™ Plastic Band Organizer **M620-01**  
(Sizes 29 1/2 to 44)

Saturn™ Plastic Band Organizer **M630-01**  
(Sizes 1 to 32)



### Stackable Band Organizer

- Modular interlocking design
- Constructed with high quality durable plastic
- Accommodates our plastic band organizer (ordered separately)

Stackable Band Organizer **S407-01**

## TITAN™ MOLAR BANDS

G&H® has taken the guesswork out of ordering a band kit. Each band kit includes left and right molar bands graduated in even, closely spaced increments. Choose from four kit assortments:

### Trial Kit

80 Total Bands  
40 Lefts and 40 Rights  
Sizes 32-39

### Intro Kit

150 Total Bands  
75 Lefts and 75 Rights  
Sizes 29½ - 44

### Pro Kit

300 Total Bands  
150 Lefts and 150 Rights  
Sizes 29½ - 44

### Master Kit

600 Total Bands  
300 Lefts and 300 Rights  
Sizes 29½ - 44

Kits include a plastic band organizer.

### Individual Titan™ Molar Bands

Size	Maxillary 1 <sup>st</sup> & 2 <sup>nd</sup> Molar		Mandibular 1 <sup>st</sup> Molar		Mandibular 2 <sup>nd</sup> Molar	
	Left	Right	Left	Right	Left	Right
29.5	B10-UL-295	B10-UR-295	B10-LL-295	B10-LR-295	B11-LL-295	B11-LR-295
30	B10-UL-300	B10-UR-300	B10-LL-300	B10-LR-300	B11-LL-300	B11-LR-300
30.5	B10-UL-305	B10-UR-305	B10-LL-305	B10-LR-305	B11-LL-305	B11-LR-305
31	B10-UL-310	B10-UR-310	B10-LL-310	B10-LR-310	B11-LL-310	B11-LR-310
31.5	B10-UL-315	B10-UR-315	B10-LL-315	B10-LR-315	B11-LL-315	B11-LR-315
32	B10-UL-320	B10-UR-320	B10-LL-320	B10-LR-320	B11-LL-320	B11-LR-320
32.5	B10-UL-325	B10-UR-325	B10-LL-325	B10-LR-325	B11-LL-325	B11-LR-325
33	B10-UL-330	B10-UR-330	B10-LL-330	B10-LR-330	B11-LL-330	B10-LR-330
33.5	B10-UL-335	B10-UR-335	B10-LL-335	B10-LR-335	B11-LL-335	B11-LR-335
34	B10-UL-340	B10-UR-340	B10-LL-340	B10-LR-340	B11-LL-340	B11-LR-340
34.5	B10-UL-345	B10-UR-345	B10-LL-345	B10-LR-345	B11-LL-345	B11-LR-345
35	B10-UL-350	B10-UR-350	B10-LL-350	B10-LR-350	B11-LL-350	B11-LR-350
35.5	B10-UL-355	B10-UR-355	B10-LL-355	B10-LR-355	B11-LL-355	B11-LR-355
36	B10-UL-360	B10-UR-360	B10-LL-360	B10-LR-360	B11-LL-360	B11-LR-360
36.5	B10-UL-365	B10-UR-365	B10-LL-365	B10-LR-365	B11-LL-365	B11-LR-365
37	B10-UL-370	B10-UR-370	B10-LL-370	B10-LR-370	B11-LL-370	B11-LR-370
37.5	B10-UL-375	B10-UR-375	B10-LL-375	B10-LR-375	B11-LL-375	B11-LR-375
38	B10-UL-380	B10-UR-380	B10-LL-380	B10-LR-380	B11-LL-380	B11-LR-380
38.5	B10-UL-385	B10-UR-385	B10-LL-385	B10-LR-385	B11-LL-385	B11-LR-385
39	B10-UL-390	B10-UR-390	B10-LL-390	B10-LR-390	B11-LL-390	B11-LR-390
39.5	B10-UL-395	B10-UR-395	B10-LL-395	B10-LR-395	B11-LL-395	B11-LR-395
40	B10-UL-400	B10-UR-400	B10-LL-400	B10-LR-400	B11-LL-400	B11-LR-400
40.5	B10-UL-405	B10-UR-405	B10-LL-405	B10-LR-405	B11-LL-405	B11-LR-405
41	B10-UL-410	B10-UR-410	B10-LL-410	B10-LR-410	B11-LL-410	B11-LR-410
41.5	B10-UL-415	B10-UR-415	B10-LL-415	B10-LR-415	B11-LL-415	B11-LR-415
42	B10-UL-420	B10-UR-420	B10-LL-420	B10-LR-420	B11-LL-420	B11-LR-420
42.5	B10-UL-425	B10-UR-425	B10-LL-425	B10-LR-425	B11-LL-425	B11-LR-425
43	B10-UL-430	B10-UR-430	B10-LL-430	B10-LR-430	N/A	N/A
43.5	B10-UL-435	B10-UR-435	B10-LL-435	B10-LR-435	N/A	N/A
44	B10-UL-440	B10-UR-440	B10-LL-440	B10-LR-440	N/A	N/A



## TITAN™ MOLAR BANDS

Choose from four kit assortments:

- Trial Kit containing 80 bands*
- Intro Kit containing 150 bands*
- Pro Kit containing 300 bands*
- Master Kit containing 600 bands*

Kit quantities include half left and half right.



### Maxillary 1<sup>st</sup> & 2<sup>nd</sup> Molar Bands

Catalog No./Type	29%	30	30%	31	31%	32	32%	33	33%	34	34%	35	35%	36	36%	37	37%	38	38%	39	39%	40	40%	41	41%	42	42%	43	43%	44
K10-UP-TRIAL (80)	-	-	-	-	-	2	2	4	4	4	6	6	10	10	10	6	6	4	4	2	-	-	-	-	-	-	-	-	-	-
K10-UP-INTRO (150)	2	2	2	2	2	2	4	4	6	8	10	10	10	10	12	12	10	8	6	4	4	4	2	2	2	2	2	2	2	2
K10-UP-PRO-(300)	4	4	4	4	4	4	8	8	12	16	20	20	20	20	24	24	20	16	12	8	8	8	4	4	4	4	4	4	4	4
K10-UP-MASTER (600)	8	8	8	8	8	8	16	16	24	32	40	40	40	40	48	48	40	32	24	16	16	16	8	8	8	8	8	8	8	8



### Mandibular 1<sup>st</sup> Molar Bands

Catalog No./Type	29%	30	30%	31	31%	32	32%	33	33%	34	34%	35	35%	36	36%	37	37%	38	38%	39	39%	40	40%	41	41%	42	42%	43	43%	44
K10-LO-TRIAL (80)	-	-	-	-	-	2	2	4	4	4	6	6	10	10	10	6	6	4	4	2	-	-	-	-	-	-	-	-	-	-
K10-LO-INTRO (150)	2	2	2	2	2	2	4	4	6	8	10	10	10	10	12	12	10	8	6	4	4	4	2	2	2	2	2	2	2	2
K10-LO-PRO-(300)	4	4	4	4	4	4	8	8	12	16	20	20	20	20	24	24	20	16	12	8	8	8	4	4	4	4	4	4	4	4
K10-LO-MASTER (600)	8	8	8	8	8	8	16	16	24	32	40	40	40	40	48	48	40	32	24	16	16	16	8	8	8	8	8	8	8	8



### Mandibular 2<sup>nd</sup> Molar Bands

Catalog No./Type	29%	30	30%	31	31%	32	32%	33	33%	34	34%	35	35%	36	36%	37	37%	38	38%	39	39%	40	40%	41	41%	42
K11-LO-TRIAL (80)	-	-	-	-	-	2	2	4	4	4	6	6	10	10	10	6	6	4	4	-	-	-	-	-	-	-
K11-LO-INTRO (150)	2	2	2	2	2	2	4	6	8	8	10	10	10	10	12	12	10	8	8	6	4	4	2	2	2	2
K11-LO-PRO-(300)	4	4	4	4	6	8	8	8	12	14	16	18	20	24	24	24	20	18	16	12	10	6	6	6	4	4
K11-LO-MASTER (600)	8	8	8	8	12	16	18	22	26	32	40	40	48	48	48	40	36	30	24	20	16	12	12	12	8	8



## SATURN™ MOLAR BANDS

G&H® has taken the guesswork out of ordering a band kit. Each band kit includes left and right molar bands graduated in even, closely spaced increments. Choose from four kit assortments:

### Trial Kit

80 Total Bands  
40 Lefts and 40 Rights  
Sizes 6-20

### Intro Kit

150 Total Bands  
75 Lefts and 75 Rights  
Sizes 1-32

### Pro Kit

300 Total Bands  
150 Lefts and 150 Rights  
Sizes 1-32

### Master Kit

600 Total Bands  
300 Lefts and 300 Rights  
Sizes 1-32

Kits include a plastic band organizer.

### Individual Saturn™ Molar Bands

### Saturn™ Bicuspid Bands

Size	Maxillary 1 <sup>st</sup> & 2 <sup>nd</sup> Molar		Mandibular 1 <sup>st</sup> Molar		Mandibular 2 <sup>nd</sup> Molar		Upper/Lower Bicuspid	
	Left	Right	Left	Right	Left	Right	Upper	Lower
1	B12-UL-01	B12-UR-0-1	B12-LL-01	B12-LR-01	B13-LL-01	B13-LR-01	B22-UP-01	B24-LO-01
2	B12-UL-02	B12-UR-02	B12-LL-02	B12-LR-02	B13-LL-02	B13-LR-02	B22-UP-02	B24-LO-02
3	B12-UL-03	B12-UR-03	B12-LL-03	B12-LR-03	B13-LL-03	B13-LR-03	B22-UP-03	B24-LO-03
4	B12-UL-04	B12-UR-04	B12-LL-04	B12-LR-04	B13-LL-04	B13-LR-04	B22-UP-04	B24-LO-04
5	B12-UL-05	B12-UR-05	B12-LL-05	B12-LR-05	B13-LL-05	B13-LR-05	B22-UP-05	B24-LO-05
6	B12-UL-06	B12-UR-06	B12-LL-06	B12-LR-06	B13-LL-06	B13-LR-06	B22-UP-06	B24-LO-06
7	B12-UL-07	B12-UR-07	B12-LL-07	B12-LR-07	B13-LL-07	B13-LR-07	B22-UP-07	B24-LO-07
8	B12-UL-08	B12-UR-08	B12-LL-08	B12-LR-08	B13-LL-08	B13-LR-08	B22-UP-08	B24-LO-08
9	B12-UL-09	B12-UR-09	B12-LL-09	B12-LR-09	B13-LL-09	B13-LR-09	B22-UP-09	B24-LO-09
10	B12-UL-10	B12-UR-10	B12-LL-10	B12-LR-10	B13-LL-10	B13-LR-10	B22-UP-10	B24-LO-10
11	B12-UL-11	B12-UR-11	B12-LL-11	B12-LR-11	B13-LL-11	B13-LR-11	B22-UP-11	B24-LO-11
12	B12-UL-12	B12-UR-12	B12-LL-12	B12-LR-12	B13-LL-12	B13-LR-12	B22-UP-12	B24-LO-12
13	B12-UL-13	B12-UR-13	B12-LL-13	B12-LR-13	B13-LL-13	B13-LR-13	B22-UP-13	B24-LO-13
14	B12-UL-14	B12-UR-14	B12-LL-14	B12-LR-14	B13-LL-14	B13-LR-14	B22-UP-14	B24-LO-14
15	B12-UL-15	B12-UR-15	B12-LL-15	B12-LR-15	B13-LL-15	B13-LR-15	B22-UP-15	B24-LO-15
16	B12-UL-16	B12-UR-16	B12-LL-16	B12-LR-16	B13-LL-16	B13-LR-16	B22-UP-16	B24-LO-16
17	B12-UL-17	B12-UR-17	B12-LL-17	B12-LR-17	B13-LL-17	B13-LR-17	B22-UP-17	B24-LO-17
18	B12-UL-18	B12-UR-18	B12-LL-18	B12-LR-18	B13-LL-18	B13-LR-18	B22-UP-18	B24-LO-18
19	B12-UL-19	B12-UR-19	B12-LL-19	B12-LR-19	B13-LL-19	B13-LR-19	B22-UP-19	B24-LO-19
20	B12-UL-20	B12-UR-20	B12-LL-20	B12-LR-20	B13-LL-20	B13-LR-20	B22-UP-20	B24-LO-20
21	B12-UL-21	B12-UR-21	B12-LL-21	B12-LR-21	B13-LL-21	B13-LR-21	B22-UP-21	B24-LO-21
22	B12-UL-22	B12-UR-22	B12-LL-22	B12-LR-22	B13-LL-22	B13-LR-22	B22-UP-22	B24-LO-22
23	B12-UL-23	B12-UR-23	B12-LL-23	B12-LR-23	B13-LL-23	B13-LR-23	B22-UP-23	B24-LO-23
24	B12-UL-24	B12-UR-24	B12-LL-24	B12-LR-24	B13-LL-24	B13-LR-24	B22-UP-24	B24-LO-24
25	B12-UL-25	B12-UR-25	B12-LL-25	B12-LR-25	B13-LL-25	B13-LR-25	N/A	N/A
26	B12-UL-26	B12-UR-26	B12-LL-26	B12-LR-26	B13-LL-26	B13-LR-26	N/A	N/A
27	B12-UL-27	B12-UR-27	B12-LL-27	B12-LR-27	B13-LL-27	B13-LR-27	N/A	N/A
28	B12-UL-28	B12-UR-28	B12-LL-28	B12-LR-28	B13-LL-28	B13-LR-28	N/A	N/A
29	B12-UL-29	B12-UR-29	B12-LL-29	B12-LR-29	B13-LL-29	B13-LR-29	N/A	N/A
30	B12-UL-30	B12-UR-30	B12-LL-30	B12-LR-30	B13-LL-30	B13-LR-29	N/A	N/A
31	B12-UL-31	B12-UR-31	B12-LL-31	B12-LR-31	B13-LL-31	B13-LR-31	N/A	N/A
32	B12-UL-32	B12-UR-32	B12-LL-32	B12-LR-32	B13-LL-32	B13-LR-32	N/A	N/A
33	B12-UL-33	B12-UR-33	B12-LL-33	B12-LR-33	B13-LL-33	B13-LR-33	N/A	N/A
34	B12-UL-34	B12-UR-34	B12-LL-34	B12-LR-34	B13-LL-34	B13-LR-34	N/A	N/A
35	B12-UL-35	B12-UR-35	B12-LL-35	B12-LR-35	B13-LL-35	B13-LR-35	N/A	N/A
36	B12-UL-36	B12-UR-36	B12-LL-36	B12-LR-36	B13-LL-36	B13-LR-36	N/A	N/A

## SATURN™ MOLAR BANDS

Choose from four kit assortments:

**Trial Kit containing 80 bands**

**Pro Kit containing 300 bands**

**Intro Kit containing 150 bands**

**Master Kit containing 600 bands**



Kit quantities include half left and half right.

### Maxillary 1<sup>st</sup> & 2<sup>nd</sup> Molar Bands

Catalog No./Type	1	2	3	4	5	6	7	8	9	10	11	12	13	14	15	16	17	18	19	20	21	22	23	24	25	26	27	28	29	30	31	32
K12-UP-TRIAL (80)	-	-	-	-	-	2	2	4	4	4	6	6	10	10	10	6	6	4	4	2	-	-	-	-	-	-	-	-	-	-	-	-
K12-UP-INTRO (150)	2	2	2	2	2	2	4	4	6	8	8	10	10	10	12	10	10	8	6	4	4	4	2	2	2	2	2	2	2	2	2	
K12-UP-PRO-(300)	4	4	4	4	4	4	8	8	12	16	16	20	20	20	24	20	20	16	12	8	8	8	4	4	4	4	4	4	4	4	4	
K12-UP-MASTER (600)	8	8	8	8	8	8	16	16	24	32	32	40	40	40	48	40	40	32	24	16	16	16	8	8	8	8	8	8	8	8	8	

### Mandibular 1<sup>st</sup> Molar Bands

Catalog No./Type	1	2	3	4	5	6	7	8	9	10	11	12	13	14	15	16	17	18	19	20	21	22	23	24	25	26	27	28	29	30	31	32
K12-LO-TRIAL (80)	-	-	-	-	-	2	2	4	4	4	6	6	10	10	10	6	6	4	4	2	-	-	-	-	-	-	-	-	-	-	-	
K12-LO-INTRO (150)	2	2	2	2	2	2	4	4	6	8	8	10	10	10	12	10	10	8	6	4	4	4	2	2	2	2	2	2	2	2	2	
K12-LO-PRO-(300)	4	4	4	4	4	4	8	8	12	16	16	20	20	20	24	20	20	16	12	8	8	8	4	4	4	4	4	4	4	4	4	
K12-LO-MASTER (600)	8	8	8	8	8	8	16	16	24	32	32	40	40	40	48	40	40	32	24	16	16	16	8	8	8	8	8	8	8	8	8	

### Mandibular 2<sup>nd</sup> Molar Bands

Catalog No./Type	1	2	3	4	5	6	7	8	9	10	11	12	13	14	15	16	17	18	19	20	21	22	23	24	25	26	27	28	29	30	31	32
K13-LO-TRIAL (80)	-	-	-	-	-	2	2	4	4	4	6	6	10	10	10	6	6	4	4	2	-	-	-	-	-	-	-	-	-	-	-	
K13-LO-INTRO (150)	2	2	2	2	2	2	4	4	6	8	8	10	10	10	12	10	10	8	6	4	4	4	2	2	2	2	2	2	2	2	2	
K13-LO-PRO-(300)	4	4	4	4	4	4	8	8	12	16	16	20	20	20	24	20	20	16	12	8	8	8	4	4	4	4	4	4	4	4	4	
K13-LO-MASTER (600)	8	8	8	8	8	8	16	16	24	32	32	40	40	40	48	40	40	32	24	16	16	16	8	8	8	8	8	8	8	8	8	

## SATURN™ BICUSPID BANDS

All Saturn™ bicuspids bands are permanently etched using an electro Chemical Etching process for easy permanent identification. Interiors are micro-etched for roughness to increase bond strength.

### Maxillary 1<sup>st</sup> & 2<sup>nd</sup> Bicuspid Bands

Catalog No./Type	1	2	3	4	5	6	7	8	9	10	11	12	13	14	15	16	17	18	19	20	21	22	23	24
K22-UP-TRIAL (80)	-	-	2	2	2	4	4	4	6	6	6	8	8	6	4	4	4	2	2	2	2	2	-	-
K22-UP-INTRO (150)	2	2	4	4	4	6	6	8	10	10	12	12	12	10	10	8	6	6	4	4	4	2	2	2
K22-UP-PRO-(300)	4	4	8	8	8	12	12	16	20	20	24	24	24	20	20	16	12	12	8	8	8	4	4	4
K22-UP-MASTER (600)	8	8	16	16	16	24	24	32	40	40	48	48	48	40	40	32	24	24	16	16	16	8	8	8

### Mandibular 1<sup>st</sup> & 2<sup>nd</sup> Bicuspid Bands

Catalog No./Type	1	2	3	4	5	6	7	8	9	10	11	12	13	14	15	16	17	18	19	20	21	22	23	24
K24-LO-TRIAL (80)	-	-	2	2	2	4	4	4	6	6	6	8	8	6	4	4	4	2	2	2	2	2	-	-
K24-LO-INTRO (150)	2	2	4	4	4	6	6	8	10	10	12	12	12	10	10	8	6	6	4	4	4	2	2	2
K24-LO-PRO-(300)	4	4	8	8	8	12	12	16	20	20	24	24	24	20	20	16	12	12	8	8	8	4	4	4
K24-LO-MASTER (600)	8	8	16	16	16	24	24	32	40	40	48	48	48	40	40	32	24	24	16	16	16	8	8	8

# Auxiliary Attachments

## NEW ITEM!

Freddy™ Patent pending, by Gestenco International AB

### Ceramic Buttons

10/pkg.

Maintains the transparent look with aligners as anchorage for elastics. Works lingually & labially. Anatomical mesh base for strong bond fits all teeth.

**CLB10**



Weldable

### Lingual Buttons

20/pkg.

Flat  
Curved

**WLBF20**  
**WLBC20**



Direct Bond

### Lingual Buttons

20/pkg.

Flat  
Curved

**BLBF20**  
**BLBC20**



### Buttons

The domed head allows for maximum patient comfort.

Semi-Flat Ea.

Weldable  
**M020-01**

Semi-Flat Low Prof. Ea.

**M020-02**

Mini Ea.

•

Bondable

•

•

**M021B-01**



Weldable

### Lingual Cleats

Short - 2,000/pkg.  
Long - 1,000/pkg.

**WLCSHORTS**  
**WLCLONGS**

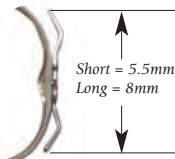

Direct Bond

### Lingual Cleats

20/pkg.

Curved

**270-212**



### Lingual Cleats

Large 8.1mm Ea.

Weldable  
**M015-01**

Small 5.3mm Ea.

**M015-02**

Gull Wing 4.2mm Ea.

**M015-03**

Bondable

**M015B-01**

**M015B-02**

**M015B-03**



Weldable

### Lingual Sheaths

10/pkg.

.036" Right - w/Hook  
.036" Left - w/Hook

**WLS055R**  
**WLS055L**



Weldable

### Lingual Sheaths

Universal

Ea.

**M040-01**



Weldable, Universal

### Lingual Sheaths

With no window, with indent.

Ea.

**M040-06**

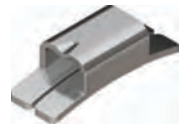

Weldable

### Lingual Sheaths

With window, indent, and mesial ball hook.

UR/LL Ea.

**M040-04**

UL/LR Ea.

**M040-05**



Weldable

### Lingual Sheaths

With window, indent and distal ball hook.

UR/LL Ea.

**M040-09**

UL/LR Ea.

**M040-10**



Weldable, Universal

### Seating Lug

Ea.

**M010-03**



Weldable

### Eyelets

.036 ID

Small Ea.

**M005-01**



Direct Bond

### Coil Eyelets

Round base with .036 inside dia. opening.

Ea.

**M006B-01**



Direct Bond

### Composite Eyelets

5/pkg.

**CMEYE**



Weldable

### Elastic Lugs

Combining an elongated hook with a seating lug prevents elastics from slipping off.

Flat Ea.

**M011-01**

Curved Ea.

**M011-02**



# Wire Products | Springs

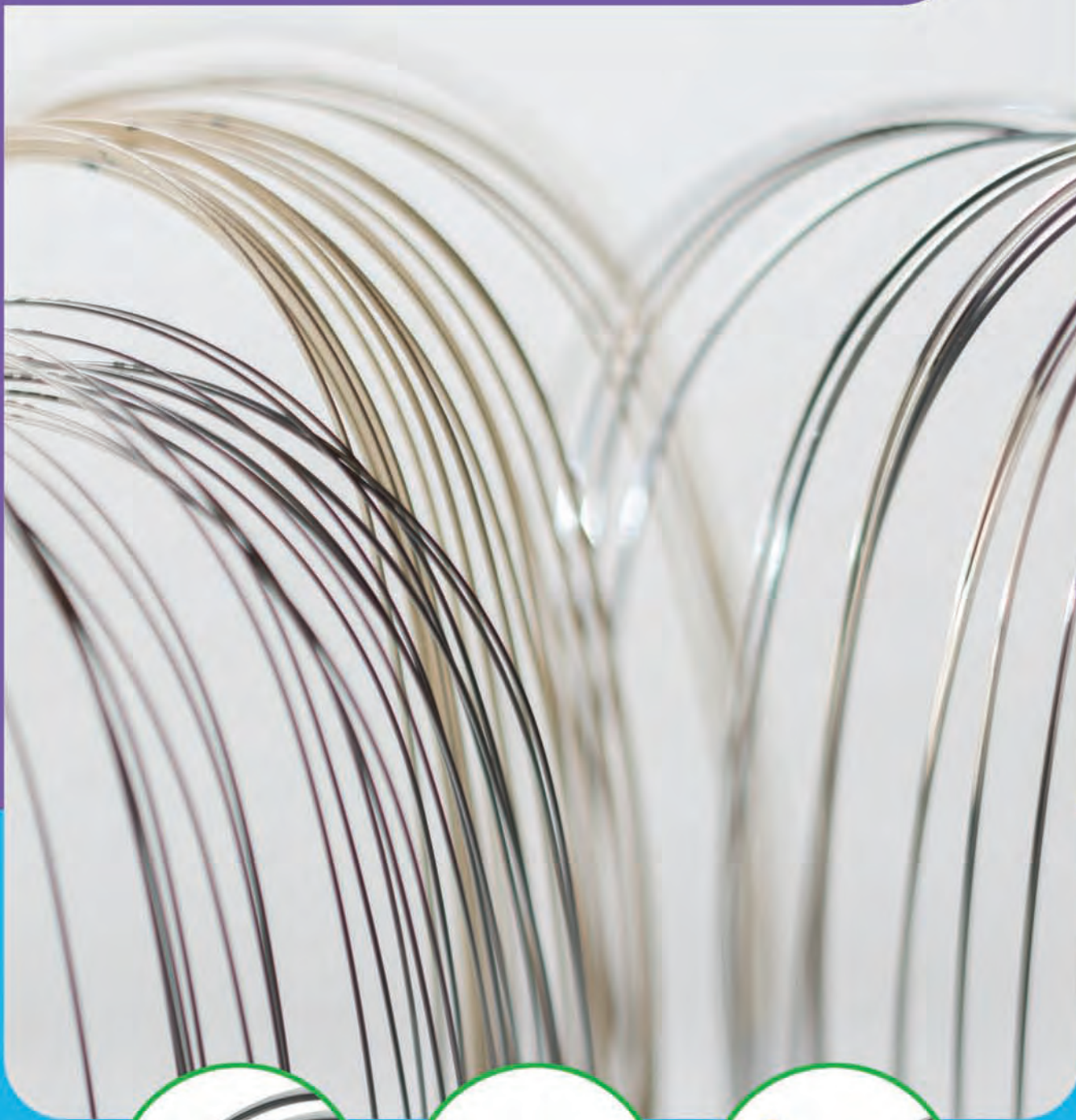

As a wire manufacturer, G&H® maintains total control of all production processes .

# Archwires



## M5™ THERMAL COPPER NICKEL TITANIUM

- Available in:**
- All Archforms
  - Reverse Curve
  - Pre-Stopped
  - Lingual Arches

See Page 43



## G4™ NICKEL TITANIUM

- Available in:**
- All Archforms
  - Pre-Stopped
  - Pre-Torqued
  - G4orce™ Triple Force
  - Reverse Curve
  - Ultraesthetic™ Tooth-Colored
  - Lingual Arches

See Page 45



## BT3™ BETA TITANIUM

### Titanium Molybdenum Alloy\*

- Available in:**
- 5 Archforms
  - T-Loop
  - Lingual Arches

See Page 55

\*TMA is a registered trademark of Ormco Corporation



## G4™ NITI REVERSE CURVE

- Available in:**
- Reverse Curve 1 & 3
  - Europa II Reverse Curve
  - Pre-Stopped
  - Pre-Torqued
  - Thermal Niti
  - Ultraesthetic™ Tooth-Colored

See Page 53



## S304VM STAINLESS STEEL

- Available in:**
- All Archforms
  - Ultraesthetic™ Tooth-Colored
  - Lingual Arches

See Page 56



## STAINLESS STEEL MULTI-STRAND ARCHWIRES

- Available in:**
- 2 Archforms
  - Three-Strand (twisted)
  - Six-Strand (coaxial)
  - Seven-Strand (twisted)
  - Eight-Strand (woven)

See Page 64



## XR1™ HEAT TREATED STAINLESS STEEL

- Available in:**
- All Archforms
  - Brass Ball-Post Posted Archwire

See Page 57



## STAINLESS STEEL LOOPED ARCHWIRES

- Available in:**
- 2 Archforms
  - T-Loop
  - Keyhole Loop (2 & 4 Loop)

See Page 58



## STAINLESS STEEL POSTED ARCHWIRES

- Available in:**
- 4 Archforms
  - Heat-Treated Archwire with Brass Ball-Post
  - Straight Brass Post

See Page 59



## ULTRAESTHETIC™ TOOTH-COLORED

- Available in:**
- 5 Archforms
  - G4™ Nickel Titanium
  - Stainless Steel
  - Reverse Curve
  - Pre-Stopped

See Page 60

**Try G&H® Solo-Packs!**

Solo-Pack™ your archwires to eliminate cross-contamination - individually pouched, autoclavable archwires.



### Archwire Storage Box

Bulk wire box **AWCSLD**  
Solo-Pack™ box **AWCSOD**

### Additional Dividers:

Bulk wire box (5/pkg.) **DIVIDSL**  
Solo-Pack™ box (5/pkg.) **DIVIDESO**

# ARCHFORMS

ARCHFORMS ARE PICTURED ACTUAL SIZE.

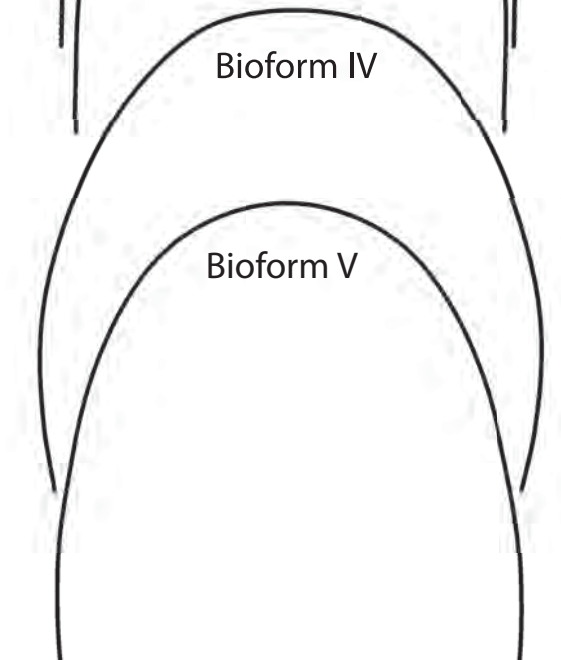
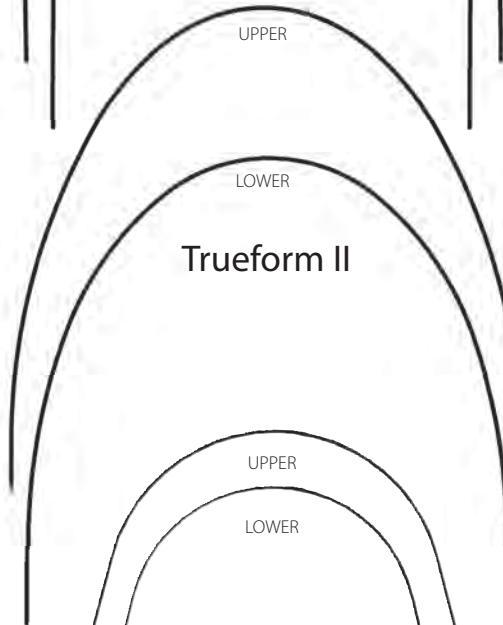
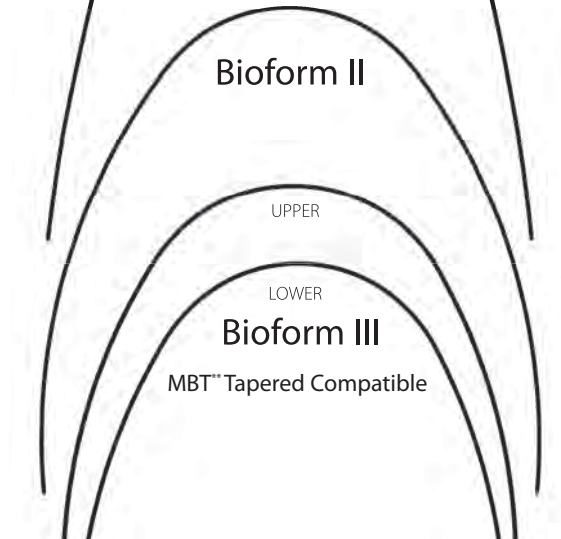
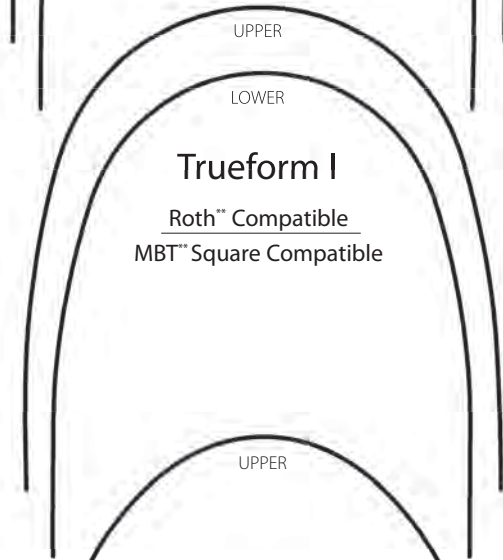
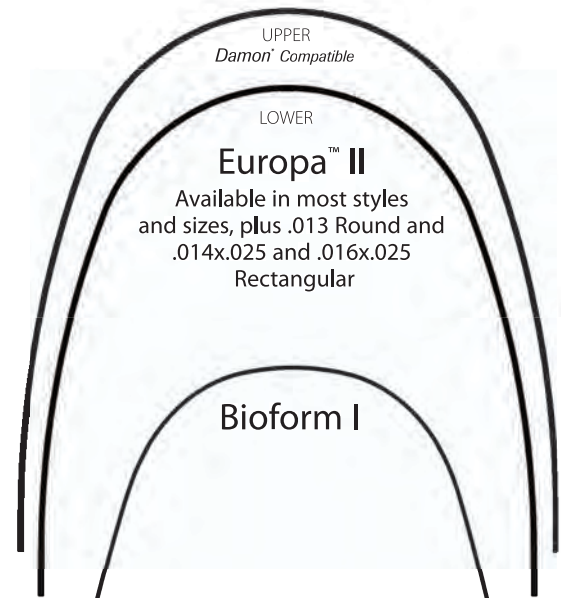
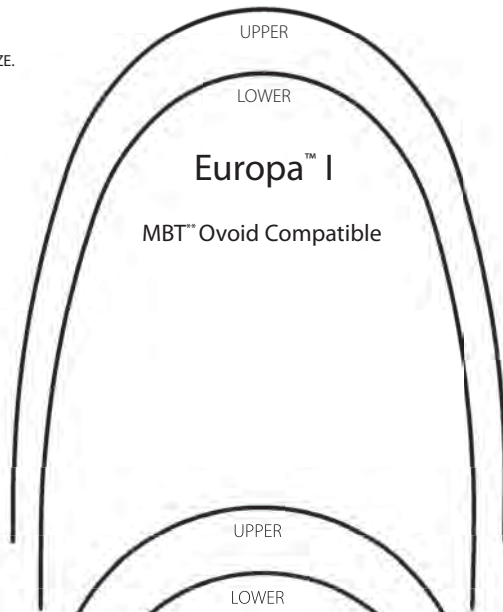

Compare size to scale for reproduction distortion.

\*G&H® Wire is in no way affiliated with or endorsed by Ormco Corporation or Dr. Dwight Damon.

\*\*G&H® prescriptions are not implied to be an exact version of any other system, nor do we claim any endorsement by the doctor.

MBT is a trademark of 3M Unitek Corporation.

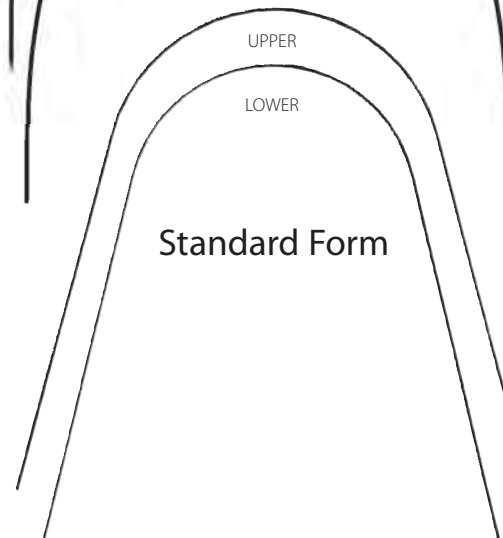

# Lingual Archform Options

See pages 61-62 for more information on these archforms.

## Preformed Lingual Arches

(Shown actual size)

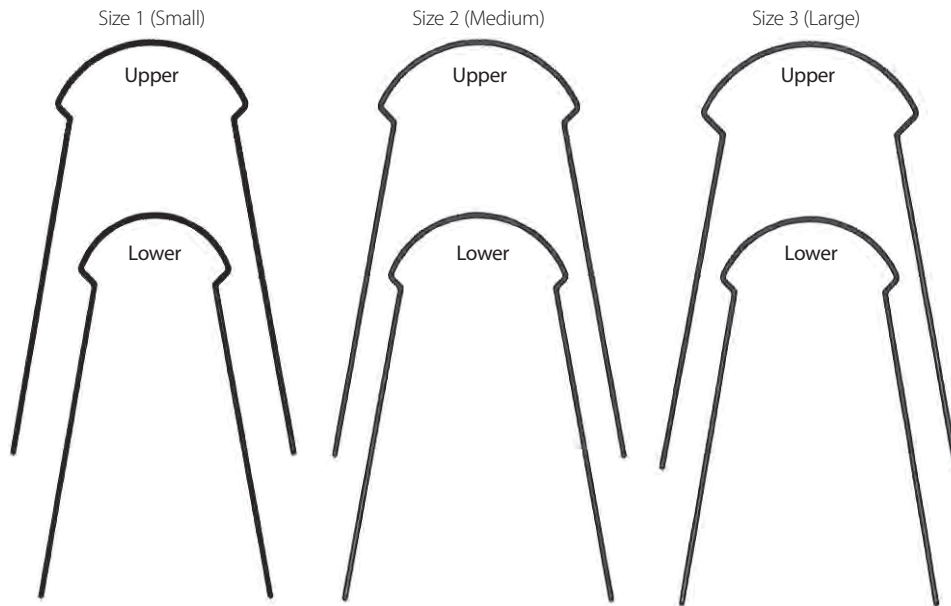

## Universal Lingual Arches

(Shown actual size)

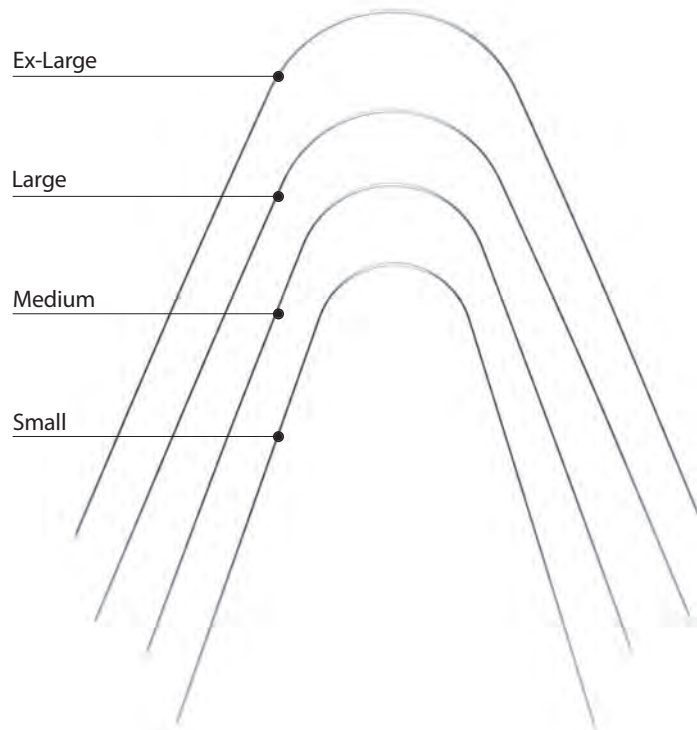

Compare size to scale for reproduction distortion.



G&H® Exclusive Archforms

# DYB™ Pretorqued Archwire Series

ARCHFORMS ARE PICTURED ACTUAL SIZE. See pages 50-52 for more information on these archforms

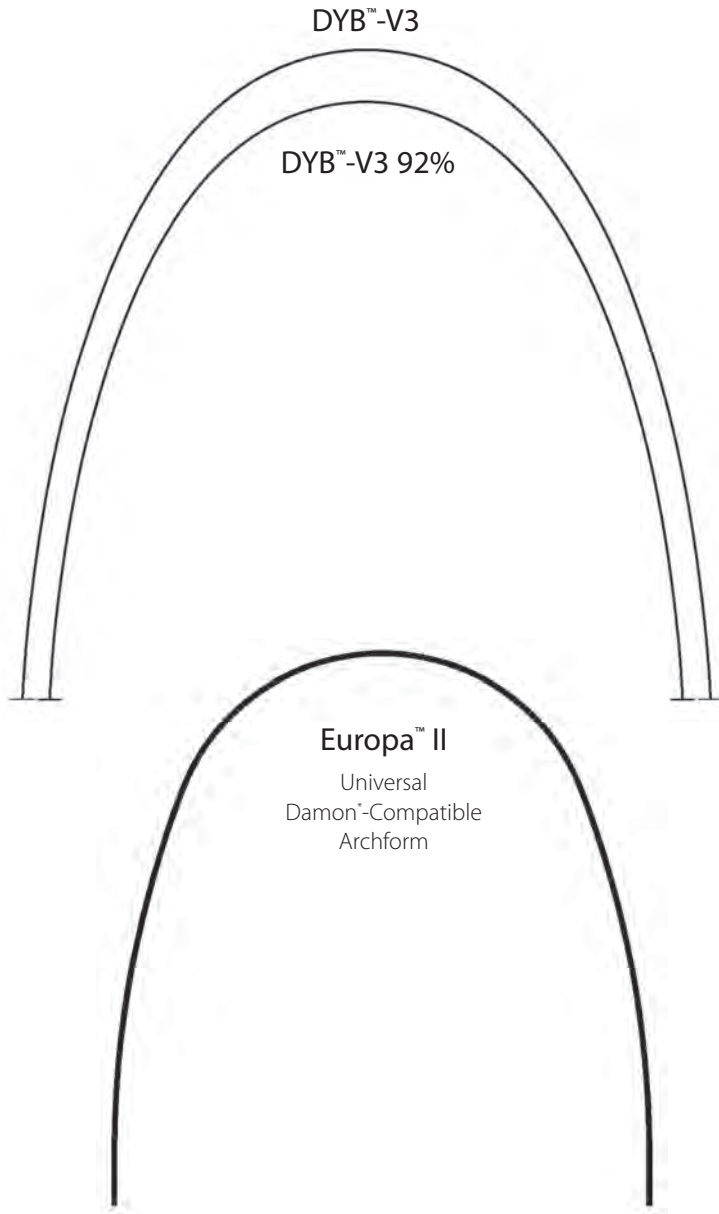

*"For over 40 years, we have manufactured wires that provide consistent working properties for optimal clinical results."*

## Archwire Dispenser

Our archwire dispenser organizes up to 12 sets of archwires neatly and efficiently. Manufactured of anodized aluminum, this rack can be thoroughly cleaned and sterilized as desired. Light weight and attractive, this dispenser will compliment any office décor.

3 3/4" wide x 7 7/8" long x 1 3/4" high

Anodized aluminum **AWDSA100**



Compare size to scale for reproduction distortion.

\*G&H® Wire is in no way affiliated with or endorsed by Ormco Corporation or Dr. Dwight Damon.

## Material Science / Scientific Testing

G&H® NiTi archwires deliver the clinical expectations of extreme elasticity, consistent force, and shape memory, realized over a range of deflection.

G&H® Orthodontics is a recognized leader in manufacturing Nickel Titanium wire products. Continuous and meticulous testing of our wires ensures the high standards of performance we guarantee. State-of-the-art stress/strain testing of Nickel Titanium wire is performed employing a three-point deflection test (fig. A) with a load cell probe impacting a wire and recording the forces throughout the range from deflection to recovery. The test data (force vs. deflection) must validate that each production batch meets our stringent specifications. The data is then documented and archived on a hysteresis graph (fig. B) for each production batch we manufacture.



### How a Hysteresis Graph demonstrates if a NiTi wire will fulfill the clinical expectations of elasticity, consistent force and shape memory.

- 1 Start test – Load cell contacts wire and begins deflection in 37 °C waterbath
- 2 Extreme elasticity shown by the Load Resistance Force (bump in the graph) at 0.6mm deflection
  - This wire is active and aggressive as it transitions from the Austenitic (increasing force) to Martensitic (constant force) state
- 3 Consistent forces of Martensitic response
  - Engagement forces have “flatlined” at 230g as the wire is deflected from 0.6mm to 2.0mm
  - Desired, defined excursion of Martensitic phenomenon (constant force over a large deflection) exhibited represents properties unique to effective Superelastic Niti wire
- 4 Extreme elasticity and consistent force shown at 3.0mm deflection
  - Peak load force of 230g at 2.0mm deflection is consistent with force levels at the 0.6mm deflection point during engagement
  - Transitional rebound shows the wire is active and aggressive as engagement forces cease and recovery forces begin applying tooth moving force
- 5 Consistent unload force as Martensitic state is reentered during recovery
  - Tooth moving forces dissipate slightly then stabilize to ensure consistent unload to shape memory - Average unload (tooth moving) force is 138.75g
- 6 Shape memory and elasticity are expressed
  - Full shape memory rebound occurs at 130g ensuring continuity of effective tooth moving forces through complete shape recovery

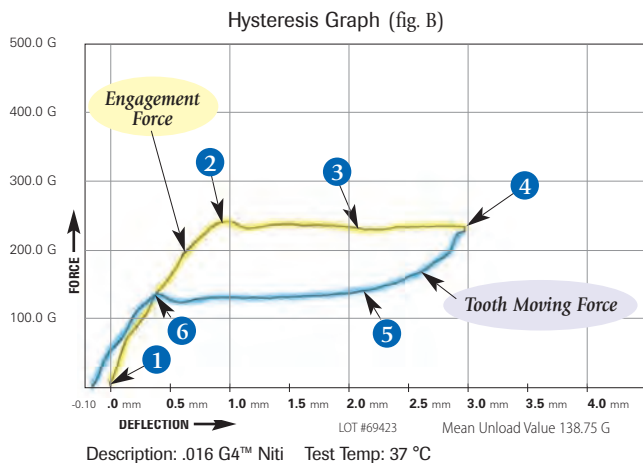
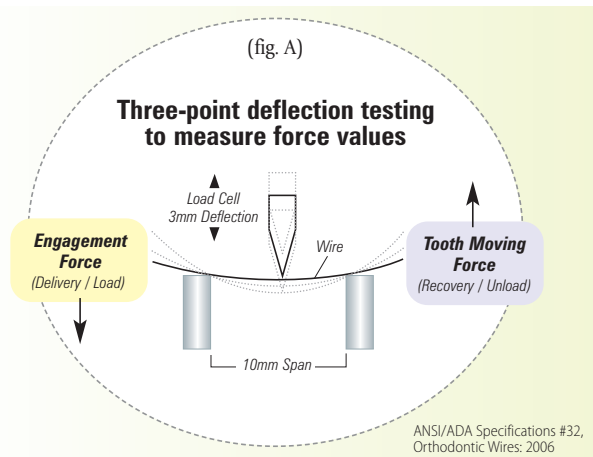

## Force Value Graphs of G&H® Archwires

G&H® tests and evaluates every production run of archwires to ensure they meet our stringent performance standards. All results are relative only to G&H® brand archwires.

*Each wire lot undergoes continuous & meticulous testing and 100% final inspection so that performance characteristics can be guaranteed.*

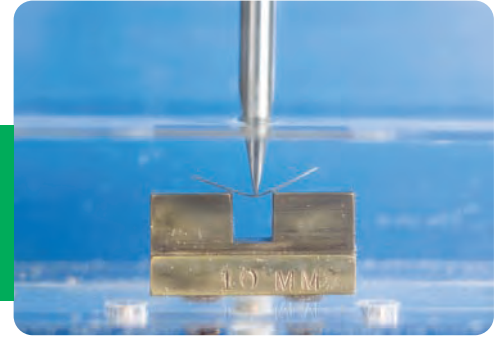

### Recovery Force of G4™ Nickel Titanium\*

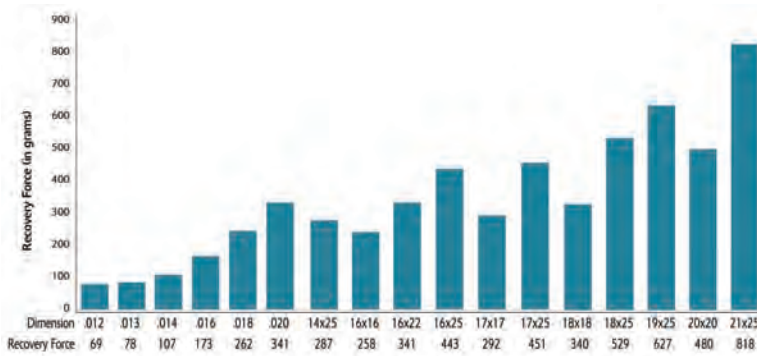

### Recovery Force of BT3™ Beta Titanium\* (Titanium Molybdenum)



### Recovery Force of M5™ Thermal Copper Nickel Titanium\*



### Recovery Force of Multi-Strand S304vm Stainless Steel

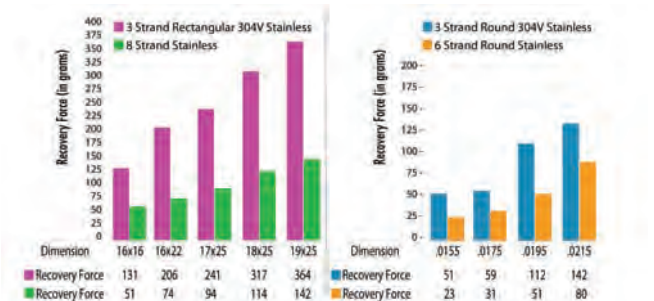

### Recovery Force of S304vm Stainless Steel

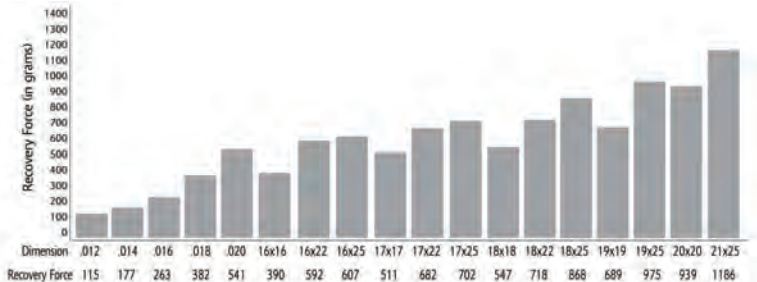

### Recovery Force of XR1™ Heat Treated Stainless Steel

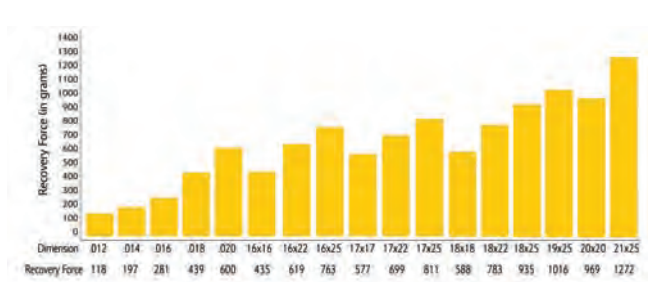

\*Tested to ANSI/ADA Specifications #32, Orthodontic Wires: 2006  
Rectangular wires measured on the vertical plane.

# More choices in Nickel Titanium

FROM THE WORLD'S BEST MANUFACTURER OF PREMIUM ARCHWIRES



Compare our best selling  
**G4™ NiTi** and **NEW M5™ Thermal Copper NiTi!**

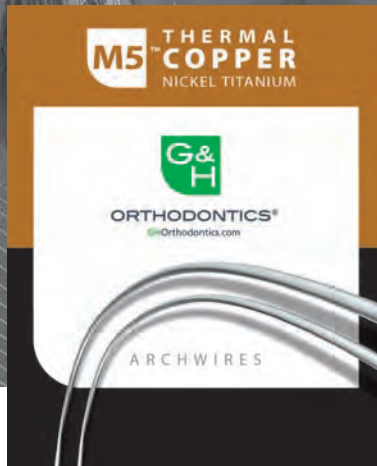

M5™ Thermal Copper NiTi is available in all archform shapes - Please contact us for a sample in your preferred wire size. It is our pleasure to send it to you!

G4™ NiTi is available in all archform shapes - Please contact us for a sample in your preferred wire size. It is our pleasure to send it to you!

See pages 43 & 44 for product details

Experience the G&H difference – Request a

**FREE SAMPLE\***

Call 888-526-1026  
 or visit [GHOrthodontics.com](http://GHOrthodontics.com)  
 Promo code: WIRESAMPLE

See and order our full line of products at  
[GHOrthodontics.com](http://GHOrthodontics.com)

\*First-time users only

Comparative Hysteresis Graph  
 M5™ Thermal Copper NiTi & G4™ Nickel Titanium Archwires

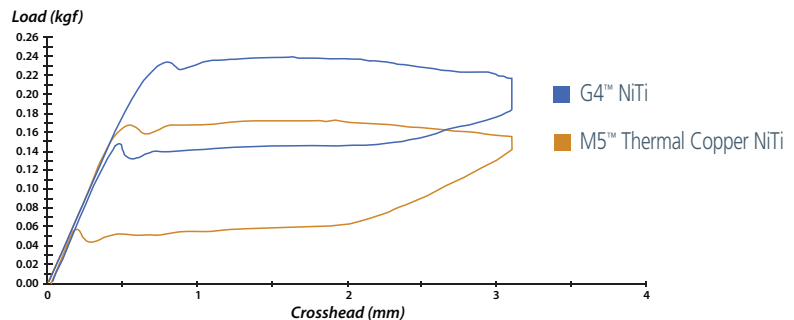

## M5™ Thermal Copper NiTi Archwires

G&H®

### M5™ Thermal Copper Nickel Titanium Archwires TOP SELLER!

Precision Manufactured By G&H® Orthodontics



#### New and Improved – M5™ Thermal Copper Nickel Titanium

A premium wire that incorporates a precise temperature transformation of 27°C for predictable tooth moving forces. G&H quality manufacturing and testing processes make M5™ Copper Nickel Titanium distinct from all other archwires used in orthodontics.

#### Order Information:

**Standard Pack** – 25 archwires/pack

**Solo-Packs™** – 10 individually sealed autoclavable archwires per carton. For Solo-Pack™ wires, add "S" to the end of part number. Please allow 2-3 days for Solo-Pack™ packaging.



**Dimpled Midline** – For Dimpled Midline wires, add "D" to the end of part number – for Dimpled Solo-Pack™ add "DS" to the end of part number. (Note: size .012 is not available with dimple).

#### Optional Dimpled Midline wires available –

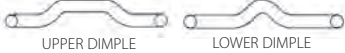

### M5™ Thermal Copper Nickel Titanium Archwires - Archform chart on page 37

• 25/pack - Bulk Pack

Damon®-Compatible

	Trueform™ I		Trueform™ II		Europa™ I		Europa™ II	
	UPPER	LOWER	UPPER	LOWER	UPPER	LOWER	UPPER	LOWER
.012	M5TFU012	M5TFL012	M5TFU112	M5TFL112	M5EFU012	M5EFL012	M5EFU112	M5EFL112
.014	M5TFU014	M5TFL014	M5TFU114	M5TFL114	M5EFU014	M5EFL014	M5EFU114	M5EFL114
.016	M5TFU016	M5TFL016	M5TFU116	M5TFL116	M5EFU016	M5EFL016	M5EFU116	M5EFL116
.018	M5TFU018	M5TFL018	M5TFU118	M5TFL118	M5EFU018	M5EFL018	M5EFU118	M5EFL118
.020	M5TFU020	M5TFL020	M5TFU120	M5TFL120	M5EFU020	M5EFL020	M5EFU120	M5EFL120
.014x.025	N/A	N/A	N/A	N/A	N/A	N/A	M5EFU3425	M5EFL3425
.016x.016	M5TFU1616	M5TFL1616	M5TFU3616	M5TFL3616	M5EFU1616	M5EFL1616	M5EFU3616	M5EFL3616
.016x.022	M5TFU1622	M5TFL1622	M5TFU3622	M5TFL3622	M5EFU1622	M5EFL1622	M5EFU3622	M5EFL3622
.016x.025	N/A	N/A	N/A	N/A	N/A	N/A	M5EFU3625	M5EFL3625
.017x.017	M5TFU1717	M5TFL1717	N/A	N/A	M5EFU1717	M5EFL1717	M5EFU3717	M5EFL3717
.017x.025	M5TFU1725	M5TFL1725	M5TFU3725	M5TFL3725	M5EFU1725	M5EFL1725	M5EFU3725	M5EFL3725
.018x.018	M5TFU1818	M5TFL1818	M5TFU3818	M5TFL3818	M5EFU1818	M5EFL1818	M5EFU3818	M5EFL3818
.018x.025	M5TFU1825	M5TFL1825	M5TFU3825	M5TFL3825	M5EFU1825	M5EFL1825	M5EFU3825	M5EFL3825
.019x.025	M5TFU1925	M5TFL1925	M5TFU3925	M5TFL3925	M5EFU1925	M5EFL1925	M5EFU3925	M5EFL3925
.020x.020	M5TFU2020	M5TFL2020	M5TFU3020	M5TFL3020	M5EFU2020	M5EFL2020	M5EFU3020	M5EFL3020
.021x.025	M5TFU2125	M5TFL2125	M5TFU3125	M5TFL3125	M5EFU2125	M5EFL2125	M5EFU3125	M5EFL3125

### M5™ Thermal Copper Nickel Titanium Archwires - Cont.

	Standard Form		Bioform I	Bioform II	Bioform III		Bioform IV	Bioform V
	UPPER	LOWER			UPPER	LOWER		
.012	M5SFU012	M5SFL012	M5BF112	M5BF212	M5BF3U012	M5BF3L012	M5BF412	M5BF512
.014	M5SFU014	M5SFL014	M5BF114	M5BF214	M5BF3U014	M5BF3L014	M5BF414	M5BF514
.016	M5SFU016	M5SFL016	M5BF116	M5BF216	M5BF3U016	M5BF3L016	M5BF416	M5BF516
.018	M5SFU018	M5SFL018	M5BF118	M5BF218	M5BF3U018	M5BF3L018	M5BF418	M5BF518
.020	M5SFU020	M5SFL020	M5BF120	M5BF220	M5BF3U020	M5BF3L020	M5BF420	M5BF520
.016x.016	M5SFU1616	M5SFL1616	M5BF11616	M5BF21616	M5BF3U1616	M5BF3L1616	M5BF41616	M5BF51616
.016x.022	M5SFU1622	M5SFL1622	M5BF11622	M5BF21622	M5BF3U1622	M5BF3L1622	M5BF41622	M5BF51622
.017x.025	M5SFU1725	M5SFL1725	M5BF11725	M5BF21725	M5BF3U1725	M5BF3L1725	M5BF41725	M5BF51725
.018x.018	M5SFU1818	M5SFL1818	M5BF11818	M5BF21818	M5BF3U1818	M5BF3L1818	M5BF41818	M5BF51818
.018x.025	M5SFU1825	M5SFL1825	M5BF11825	M5BF21825	M5BF3U1825	M5BF3L1825	M5BF41825	M5BF51825
.019x.025	M5SFU1925	M5SFL1925	M5BF11925	M5BF21925	M5BF3U1925	M5BF3L1925	M5BF41925	M5BF51925
.020x.020	M5SFU2020	M5SFL2020	M5BF12020	M5BF22020	M5BF3U2020	M5BF3L2020	M5BF42020	M5BF52020
.021x.025	M5SFU2125	M5SFL2125	M5BF12125	M5BF22125	M5BF3U2125	M5BF3L2125	M5BF42125	M5BF52125

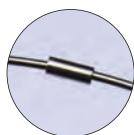

#### Pre-Stopped M5™ Available

Order Information:  
**Pre-Stopped M5™** – 25 archwires/pack  
 Add "CB" to the end of part number for pre-loaded crimpable stops. Change "CB" to "CS" for pre-loaded stops in Solo-Pack™ packaging of 10.  
 (Please allow 2-3 days for Solo-Pack™ packaging)

(Note: size .014x.025 and .016x.025 available in EP™ only - Pre-stopped archwires not available in .021x.025)



#### THERMA-STICK™ CHILLING INSTRUMENT

Handheld instrument chills Thermal NiTi wire on contact. Stainless steel tube may be used directly in mouth. Simply fill hollow tube with water, freeze and apply as desired to soften specific arch segments.  
 Ea. **THSTK**

#### THERMA FROST™ REFRIGERANT SPRAY

Chairside use for chilling Thermal Activated NiTi. For use outside the oral cavity only.

Available individually in 10 oz. cans - (Cannot be shipped internationally) **TFROST**



# G4™ Nickel Titanium Archwires

G&H®

## G4™ Nickel Titanium Archwires *Precision Manufactured By G&H® Orthodontics*



### G4™ Niti – Precision Manufactured and Scientifically Tested

- Precision manufactured for exacting tolerances in size, shape and force
- G4™ has a polished finish to reduce friction
- Extreme elasticity
- Consistent force – exacting force values insure gentle and sustained activation in every wire
- Shape memory – remains active until full archform is achieved
- Damon™ compatible force levels – from initial engagement through unraveling to full archform recovery
- Stringent testing procedures ensure every wire performs to G&H® published standards

G4™ Pre-Stopped .....	.47
G4™ Pre-Torqued .....	.50-.52
G4™ Reverse Curve .....	.50
G4™ RC Pre-Torqued .....	.54
G4™ G4orce™ Archwires .....	.46
G4™ Lingual Archwires .....	.61, .62
G4™ Springs .....	.69

*G4™ Now in all archforms  
(See pages 37 for full-size archform charts)*

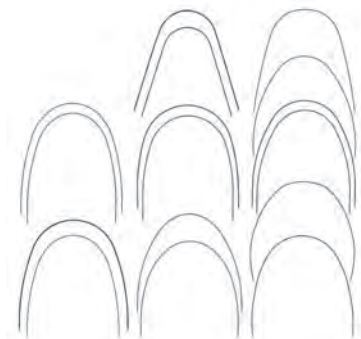

## What is G4™ NiTi?

G4™ Nickel Titanium Wire is the result of years of research and development by G&H® Orthodontics. G4™ NiTi is made possible by the vast experience and expertise that G&H® has developed in working and controlling Nickel Titanium. G4™ NiTi is superior due to refinements and advancements by G&H® in several key areas:

1. Material Science
2. Precision Manufacturing Processes
3. Scientific Testing Protocols

### I. G4™ Material Science:

The G4™ Nickel Titanium alloy is unique. G4™ has been exclusively formulated to coordinate with G&H® manufacturing processes to yield consistent specific force, memory and elasticity values.

### II. G4™ Manufacturing:

Nickel Titanium is an alloy which is complex to process and form. Very slight variations in a multitude of factors during manufacturing can alter the clinical performance of NiTi wires. The G4™ manufacturing processes, some invented, some developed and others refined by G&H®, make G4™ NiTi distinct from all other NiTi archwires used in Orthodontics.

### III. G4™ Testing:

Only scientific testing of a NiTi wire can determine its actual working characteristics. G4™ NiTi archwires undergo intense scientific testing during and after the manufacturing process, each production lot of G4™ wire undergoes 14 separate quality tests during manufacturing. Every G4™ wire then undergoes a 28-point 100% final inspection before packaging. All G4™ wires successfully pass all testing so that performance characteristics can be guaranteed.

## Evidence Based Performance

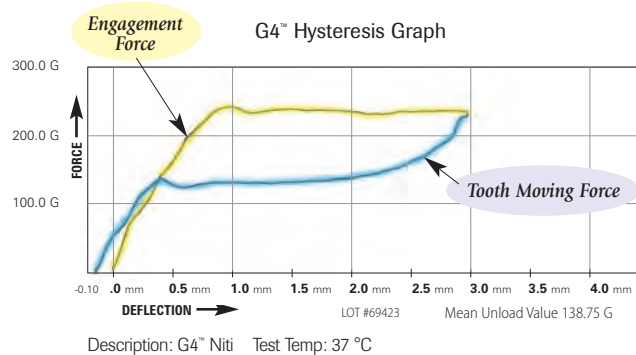

## The Clinical Significance of G4™ and M5™

The clinically significant improvements to G4™ and M5™ wire provide lower initial load forces and increased residual forces as full shape recovery progresses (see graph). Teeth move farther and faster.

Lower load forces of engagement –

- Easier wire deflection and delivery to bracket
- Less stress on bonds
- Increased patient comfort

Higher residual forces of recovery –

- Full shape recovery
- Complete unraveling and archform development
- Stays active to the end – Moves teeth the last 1/2mm

\*G&H® Wire is in no way affiliated with or endorsed by Ormco Corporation or Dr. Dwight Damon

## G4™ Nickel Titanium Archwires

G&H®

### G4™ Nickel Titanium Archwires *Precision Manufactured By G&H® Orthodontics*

**TOP SELLER!**



#### Evidence Based Performance

G&H® Orthodontic's **G4™ Nickel Titanium Archwires** and **Springs** offer significant functional enhancements to improve clinical performance.

G4™ Nickel Titanium Archwires are the culmination of years of research and development by G&H®. The uniquely enhanced performance and consistency of G4™ NiTi is the result of material science pioneered by G&H®.

The G4™ alloy coordinated with proprietary G&H® manufacturing and testing procedures guarantees the force, memory and elasticity properties are consistent as documented.

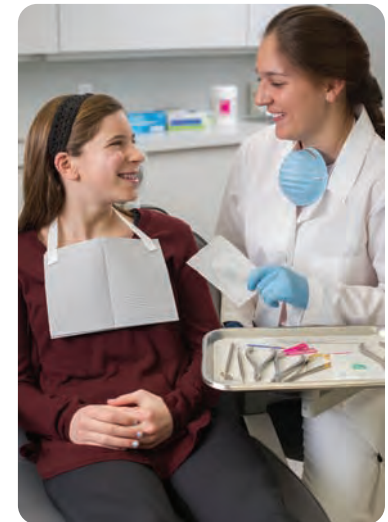

#### G4™ NiTi Archwires are available in:

- Single pack or bulk
- Optional Preloaded Stops
- Tooth-Colored Ultraesthetic™
- Equivalent Archforms for the Latest Techniques
- Optional Midline Dimple

Nickel Titanium Straight Lengths appear on page 65

#### G4™ Nickel Titanium Archwires - Archform chart on page 37

• 25/pack - Bulk Pack

Damon®-Compatible

#### Order Information:

**Standard Pack** – 25 archwires/pack

#### Solo-Packs™

– 10 individually sealed autoclavable archwires per carton.

For Solo-Pack™ wires, add "S" to the end of part number.

Please allow 2-3 days for Solo-Pack™ packaging.



#### Dimpled Midline

– For Dimpled Midline wires, add "D" to the end of part number – for Dimpled Solo-Pack™ add "DS" to the end of part number.

#### Optional Dimpled Midline wires available –

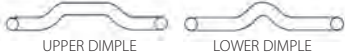

	Trueform™ I		Trueform™ II		Europa™ I		Europa™ II	
	UPPER	LOWER	UPPER	LOWER	UPPER	LOWER	UPPER	LOWER
.012	G4TFU012	G4TFL012	G4TFU112	G4TFL112	G4EFU012	G4EFL012	G4EFU112	G4EFL112
.013	N/A	N/A	N/A	N/A	G4EFU013	G4EFL013	G4EFU113	G4EFL113
.014	G4TFU014	G4TFL014	G4TFU114	G4TFL114	G4EFU014	G4EFL014	G4EFU114	G4EFL114
.016	G4TFU016	G4TFL016	G4TFU116	G4TFL116	G4EFU016	G4EFL016	G4EFU116	G4EFL116
.018	G4TFU018	G4TFL018	G4TFU118	G4TFL118	G4EFU018	G4EFL018	G4EFU118	G4EFL118
.020	G4TFU020	G4TFL020	G4TFU120	G4TFL120	G4EFU020	G4EFL020	G4EFU120	G4EFL120
.014x.025	G4TFU1425	N/A	N/A	N/A	G4EFU1425	G4EFL1425	G4EFU3425	G4EFL3425
.016x.016	G4TFU1616	G4TFL1616	G4TFU3616	G4TFL3616	G4EFU1616	G4EFL1616	G4EFU3616	G4EFL3616
.016x.022	G4TFU1622	G4TFL1622	G4TFU3622	G4TFL3622	G4EFU1622	G4EFL1622	G4EFU3622	G4EFL3622
.016x.025	N/A	N/A	N/A	N/A	G4EFU1625	G4EFL1625	G4EFU3625	G4EFL3625
.017x.017	N/A	N/A	N/A	N/A	G4EFU1717	G4EFL1717	G4EFU3717	G4EFL3717
.017x.025	G4TFU1725	G4TFL1725	G4TFU3725	G4TFL3725	G4EFU1725	G4EFL1725	G4EFU3725	G4EFL3725
.018x.018	G4TFU1818	G4TFL1818	G4TFU3818	G4TFL3818	G4EFU1818	G4EFL1818	G4EFU3818	G4EFL3818
.018x.025	G4TFU1825	G4TFL1825	G4TFU3825	G4TFL3825	G4EFU1825	G4EFL1825	G4EFU3825	G4EFL3825
.019x.025	G4TFU1925	G4TFL1925	G4TFU3925	G4TFL3925	G4EFU1925	G4EFL1925	G4EFU3925	G4EFL3925
.020x.020	G4TFU2020	G4TFL2020	G4TFU3020	G4TFL3020	G4EFU2020	G4EFL2020	G4EFU3020	G4EFL3020
.021x.025	G4TFU2125	G4TFL2125	G4TFU3125	G4TFL3125	G4EFU2125	G4EFL2125	G4EFU3125	G4EFL3125
.022x.028	G4TFU2228	G4TFL2228	N/A	N/A	N/A	N/A	N/A	N/A

#### G4™ Nickel Titanium Archwires - Cont.

	Standard Form		Bioform	Bioform	Bioform III		Bioform	Bioform
	UPPER	LOWER	I	II	UPPER	LOWER	IV	V
.012	G4SFU012	G4SFL012	G4BF112	G4BF212	G4BF3U012	G4BF3L012	G4BF412	G4BF512
.014	G4SFU014	G4SFL014	G4BF114	G4BF214	G4BF3U014	G4BF3L014	G4BF414	G4BF514
.016	G4SFU016	G4SFL016	G4BF116	G4BF216	G4BF3U016	G4BF3L016	G4BF416	G4BF516
.018	G4SFU018	G4SFL018	G4BF118	G4BF218	G4BF3U018	G4BF3L018	G4BF418	G4BF518
.020	G4SFU020	G4SFL020	G4BF120	G4BF220	G4BF3U020	G4BF3L020	G4BF420	G4BF520
.016x.016	G4SFU1616	G4SFL1616	G4BF11616	G4BF21616	G4BF3U1616	G4BF3L1616	G4BF41616	G4BF51616
.016x.022	G4SFU1622	G4SFL1622	G4BF11622	G4BF21622	G4BF3U1622	G4BF3L1622	G4BF41622	G4BF51622
.017x.025	G4SFU1725	G4SFL1725	G4BF11725	G4BF21725	G4BF3U1725	G4BF3L1725	G4BF41725	G4BF51725
.018x.018	G4SFU1818	G4SFL1818	G4BF11818	G4BF21818	G4BF3U1818	G4BF3L1818	G4BF41818	G4BF51818
.018x.025	G4SFU1825	G4SFL1825	G4BF11825	G4BF21825	G4BF3U1825	G4BF3L1825	G4BF41825	G4BF51825
.019x.025	G4SFU1925	G4SFL1925	G4BF11925	G4BF21925	G4BF3U1925	G4BF3L1925	G4BF41925	G4BF51925
.020x.020	G4SFU2020	G4SFL2020	G4BF12020	G4BF22020	G4BF3U2020	G4BF3L2020	G4BF42020	G4BF52020
.021x.025	G4SFU2125	G4SFL2125	G4BF12125	G4BF22125	G4BF3U2125	G4BF3L2125	G4BF42125	G4BF52125

\*G&H® Wire is in no way affiliated with or endorsed by Ormco Corporation or Dr. Dwight Damon

# Triple Force G4™ NiTi Archwires

G&H®

## G4orce™ Progressive Force Nickel Titanium Archwires

Precision Manufactured By G&H® Orthodontics

### G4orce™ Progressive Force Nickel Titanium

G4orce™ is a Triple Force G4™ NiTi wire with distinct zones offering progressive forces that increase from anterior to posterior. Light anterior force, medium cuspid/bicuspid force and heavy molar force.

*“Individual tooth movement is optimized when applied force synchronizes with anatomy and periodontal physiology.”*

- Small anterior teeth move best with lower forces
- Large posterior teeth move best with higher forces

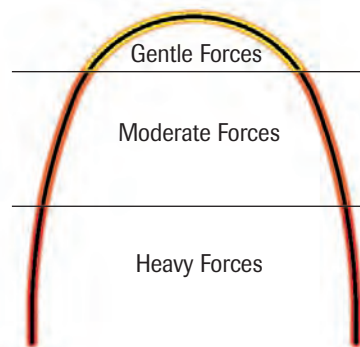

### Three Forces in One Archwire for Optimum Control

Different force values applied to different arch segments\*

- ▶ Anterior Teeth 100 grams
- ▶ Cuspid/Bicuspid 200 grams
- ▶ Molars 300 grams

\*As applied to an .019x.025 wire

### G4orce™ is available in two archforms

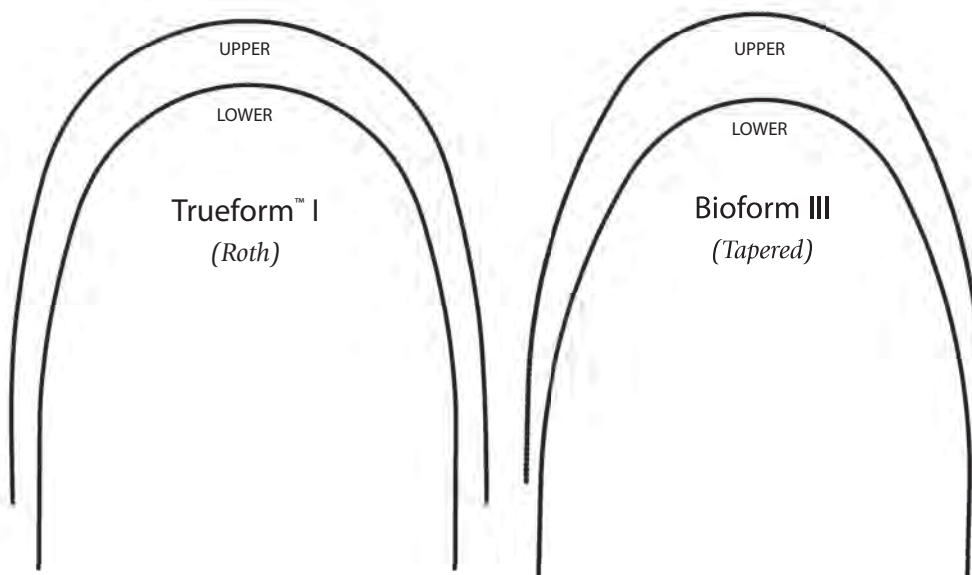

Archforms pictured actual size

#### Order Information:

**Standard Pack** – 10 archwires/pack

#### Solo-Packs™

– 10 individually sealed autoclavable archwires per carton. For Solo-Pack™ wires, add “S” to the end of part number.

*Please allow 2-3 days for Solo-Pack™ packaging.*



### G4orce™ G4™ NiTi Archwires

•10/pack

	Trueform™ I		Bioform III	
	UPPER	LOWER	UPPER	LOWER
<b>.016</b>	G4GFTU016	G4GFTL016	G4GFBU016	G4GFBL016
<b>.018</b>	G4GFTU018	G4GFTL018	G4GFBU018	G4GFBL018
<b>.016x.016</b>	G4GFTU1616	G4GFTL1616	G4GFBU1616	G4GFBL1616
<b>.016x.022</b>	G4GFTU1622	G4GFTL1622	G4GFBU1622	G4GFBL1622
<b>.017x.025</b>	G4GFTU1725	G4GFTL1725	G4GFBU1725	G4GFBL1725
<b>.018x.018</b>	G4GFTU1818	G4GFTL1818	G4GFBU1818	G4GFBL1818
<b>.018x.025</b>	G4GFTU1825	G4GFTL1825	G4GFBU1825	G4GFBL1825
<b>.019x.025</b>	G4GFTU1925	G4GFTL1925	G4GFBU1925	G4GFBL1925
<b>.020x.020</b>	G4GFTU2020	G4GFTL2020	G4GFBU2020	G4GFBL2020
<b>.021x.025</b>	G4GFTU2125	G4GFTL2125	G4GFBU2125	G4GFBL2125



## G4™ NiTi with Stops

G&H®

### G4™ Pre-Stopped Nickel Titanium Archwires

Precision Manufactured By G&H® Orthodontics



Eliminates the need to apply stops to archwires. Pre-loaded stops allow positioning as desired, then stay put until crimped. Properly tempered stops crimp easily and securely.



Stops slide and stick for desired positioning prior to crimping

Available in Europa™ II Archform Upper and Lower

Damon® Universal Compatible with Europa™ II Upper



The possibility of nickel titanium archwires slipping through brackets and migrating around the arch has long been recognized. Cinch back bends are difficult to apply and retain in NiTi. Dimple offsets at the midline have been the conventional solution to the problem.

G&H® now offers another alternative. Our new “Pre-Stopped NiTi Archwires” come pre-loaded with crimpable stops. The stops are friction fit on the wire so they slide to position and stay there. A final crimp is then applied to permanently set the stops in place. The stops are soft and crimp easily using a plier or cutter. The stops can be positioned anywhere but are generally crimped mesial to anterior crowding.

Pre-Stopped wires are effective with any bracket system and are especially popular for use with self-ligating brackets.

### Pre-Stopped G4™ NiTi Archwires

• 25/pack - Bulk Pack Damon®-Compatible

	Europa™ II		Europa™ I		Trueform™ I		Bioform III	
	UPPER	LOWER	UPPER	LOWER	UPPER	LOWER	UPPER	LOWER
.012	G4EFU112CB	G4EFL112CB	G4EFU012CB	G4EFL012CB	G4TFU012CB	G4TFL012CB	G4BF3U012CB	G4BF3L012CB
.013	G4EFU113CB	G4EFL113CB	N/A	N/A	N/A	N/A	N/A	N/A
.014	G4EFU114CB	G4EFL114CB	G4EFU014CB	G4EFL014CB	G4TFU014CB	G4TFL014CB	G4BF3U014CB	G4BF3L014CB
.016	G4EFU116CB	G4EFL116CB	G4EFU016CB	G4EFL016CB	G4TFU016CB	G4TFL016CB	G4BF3U016CB	G4BF3L016CB
.018	G4EFU118CB	G4EFL118CB	G4EFU018CB	G4EFL018CB	G4TFU018CB	G4TFL018CB	G4BF3U018CB	G4BF3L018CB
.020	G4EFU120CB	G4EFL120CB	G4EFU020CB	G4EFL020CB	G4TFU020CB	G4TFL020CB	G4BF3U020CB	G4BF3L020CB
.014 x .025	G4EFU3425CB	G4EFL3425CB	G4EFU1425CB	G4EFL1425CB	G4TFU1425CB	N/A	N/A	N/A
.016 x .016	G4EFU3616CB	G4EFL3616CB	G4EFU1616CB	G4EFL1616CB	G4TFU1616CB	G4TFL1616CB	G4BF3U1616CB	G4BF3L1616CB
.016 x .022	G4EFU3622CB	G4EFL3622CB	G4EFU1622CB	G4EFL1622CB	G4TFU1622CB	G4TFL1622CB	G4BF3U1622CB	G4BF3L1622CB
.016 x .025	G4EFU3625CB	G4EFL3625CB	G4EFU1625CB	G4EFL1625CB	N/A	N/A	N/A	N/A
.017 x .017	G4EFU3717CB	G4EFL3717CB	G4EFU1717CB	G4EFL1717CB	N/A	N/A	N/A	N/A
.017 x .025	G4EFU3725CB	G4EFL3725CB	G4EFU1725CB	G4EFL1725CB	G4TFU1725CB	G4TFL1725CB	G4BF3U1725CB	G4BF3L1725CB
.018 x .018	G4EFU3818CB	G4EFL3818CB	G4EFU1818CB	G4EFL1818CB	G4TFU1818CB	G4TFL1818CB	G4BF3U1818CB	G4BF3L1818CB
.018 x .025	G4EFU3825CB	G4EFL3825CB	G4EFU1825CB	G4EFL1825CB	G4TFU1825CB	G4TFL1825CB	G4BF3U1825CB	G4BF3L1825CB
.019 x .025	G4EFU3925CB	G4EFL3925CB	G4EFU1925CB	G4EFL1925CB	G4TFU1925CB	G4TFL1925CB	G4BF3U1925CB	G4BF3L1925CB
.020 x .020	G4EFU3020CB	G4EFL3020CB	G4EFU2020CB	G4EFL2020CB	G4TFU2020CB	G4TFL2020CB	G4BF3U2020CB	G4BF3L2020CB

Order Information:

**Standard Pack** – 25 archwires/pack, (Tooth-Colored - 10/pack)

**Solo-Packs™**

– 10 individually sealed autoclavable archwires per carton. For Solo-Pack™ wires, change “B” to “S” in part number.

Please allow 2-3 days for Solo-Pack™ packaging.



### Tooth-Colored Pre-stopped G4™ NiTi arches

For use with ceramic and composite self-ligating brackets.



• 10/pack

Europa™ II – Damon®-Compatible

	UPPER	LOWER
.014	G4EFU114CBT	G4EFL114CBT
.016	G4EFU116CBT	G4EFL116CBT
.018	G4EFU118CBT	G4EFL118CBT
.016 x .027	G4EFU3627CBT	G4EFL3627CBT
.018 x .025	G4EFU3825CBT	G4EFL3825CBT
.019 x .025	G4EFU3925CBT	G4EFL3925CBT

Available only in EFII Archform - Not available in dimpled

\*G&H® Wire is in no way affiliated with or endorsed by Ormco Corporation or Dr. Dwight Damon

# Platinum Proportion™ Archforms

Achieve Platinum Proportion™ Finished Smiles - Routinely - with Large or Small Tooth Masses

## Small teeth and/or spacing can result in less than perfect smiles

These archforms are designed for treatment of patients with smaller tooth anatomy and/or spacing. After measuring anterior teeth for over five years, we have crystallized a method to consistently deliver a predictable anterior display while idealizing functional coupling of anterior teeth. The Platinum

Proportion™ archwire system takes the guess work out of archwire selection based on a simple system of measuring tooth width of the anteriors cuspid to cuspid. This technique definitively provides the clinician the proper archwire based on the consolidated width.

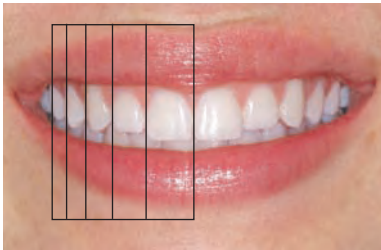

Platinum Proportion™ Gradation for Optimum Aesthetics



Cuspid on the "Sweet Spot"  
Harmonious progression of gradation



Broken Gradation  
Canines positioned anterior to the "Sweet Spot"

## The Platinum Proportion™ Archwires

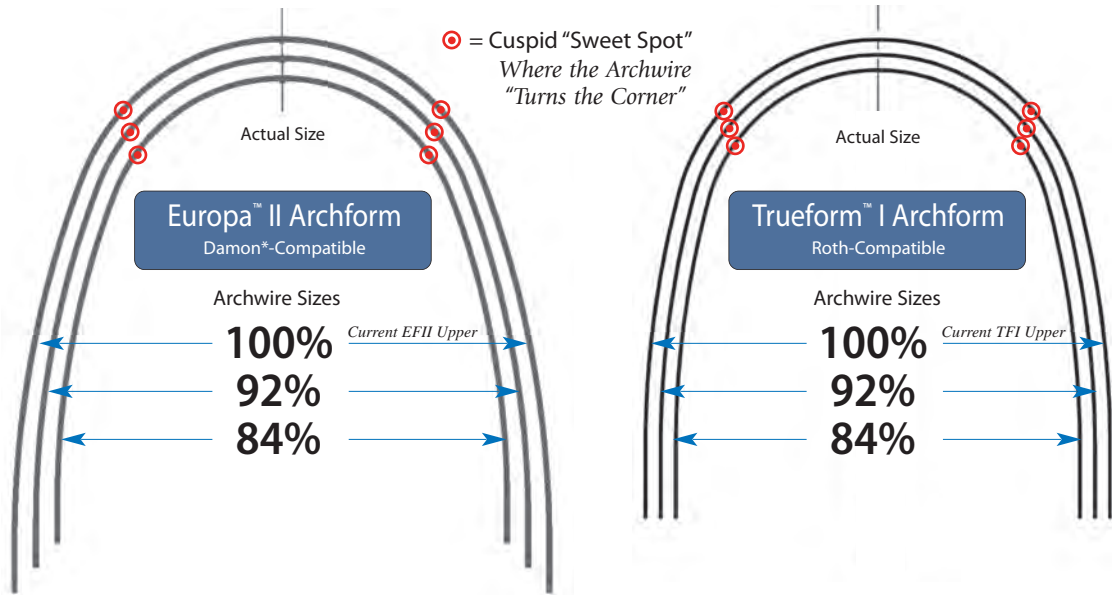

### Determining the proper archwire size



#### Measure Upper Anteriors

- Measure the mesiodistal width of each upper tooth from cuspid to cuspid
- The total measurement of all 6 teeth is then used to prescribe archform size, 100%, 92% or 84%

3	2	1	1	2	3
6.7	7.3	8.4	8.3	7.2	6.9
TOTAL = 44.8					

This case displays a consolidate width of 44.8 mm, indicating consideration of archforms 92% upper and 84% lower.

Consolidated width 3 2 1 | 1 2 3 indicates archform size:

- 40mm or Less = Customize 84%
- 40mm - 45mm = 92% Upper & 84% Lower
- 45mm - 50mm = 100% Upper & 92% Lower
- 50mm or More = Customize 100%

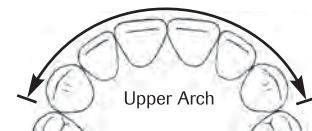



# Pre-Torqued Archwires



**DYB™ Pre-Torqued Archwire Series** Only available from G&H!  
 Precision Manufactured By G&H® Orthodontics

## Simultaneous crown torque and progressive arch expansion with one archwire.

A Damon-compatible\* archwire developed in conjunction with Duncan Brown, BSC, DDS for torque and expansion during the working and finishing stages.

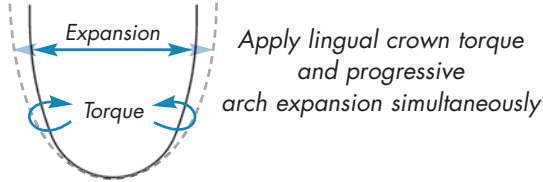

### About DYB Wires —

DYB pre-torqued wires are designed to simplify control of axial inclination, which is frequently a challenge when using PSL brackets (Standard Torque) in non extraction crowded cases. The combination of lingual crown torque through the whole arch and buccal segment expansion facilitates uprighting of the anterior teeth while developing arch width. The product is of particular interest to users of any PSL system. Play in the arch wire slot in 19x25 arch wires frequently requires arch wire bending, which is time consuming and technically difficult in TMA wires.



*Dramatic translation achieved with DYB™ Pre-Torqued Archwires. Note sagittal development and root uprighting.*



Treatment photos courtesy of Dr. Duncan Y. Brown

### DYB™-V3 & V3 92% Working Wires - available in

#### - S304 Stainless Steel

with or without 15° torque from 7 to 7

Available sizes:

- .017x.025
- .018x.018
- .019x.025
- .020x.020

#### - BT3™ Beta Titanium

with or without 20° torque from 7 to 7

Available sizes:

- .017x.025
- .019x.025
- .020x.020

#### - G4™ Nickel Titanium

without torque

Available sizes:

- .014
- .016
- .017x.025
- .018x.018
- .019x.025
- .020x.020

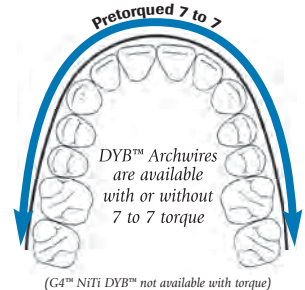

Dr. Brown

### About Duncan Y. Brown\* BSC, DDS

Dr. Brown graduated from the University of Toronto in 1975 with a Doctor of Dental Surgery and became certified as a Specialist in Orthodontics in 1978.

\*G&H® Wire is in no way affiliated with or endorsed by Ormco Corporation or Dr. Dwight Damon

## Pre-Torqued Archwires

### DYB™-V3 & V3 92% Archforms 10 wires per pkg. Bulk pack.

<b>DYB™-V3 - S304 Stainless Steel</b>		
Dimension	0° Torque	15° Torque
.017x.025	S3DYBU1725	S3DYBU1725TQ
.018x.018	S3DYBU1818	S3DYBU1818TQ
.019x.025	S3DYBU1925	S3DYBU1925TQ
.020x.020	S3DYBU2020	S3DYBU2020TQ
<b>DYB™-V3 92% - S304 Stainless Steel</b>		
Dimension	0° Torque	15° Torque
.017x.025	S3DYB92U1725	S3DYB92U1725TQ
.018x.018	S3DYB92U1818	S3DYB92U1818TQ
.019x.025	S3DYB92U1925	S3DYB92U1925TQ
.020x.020	S3DYB92U2020	S3DYB92U2020TQ
<b>DYB™-V3 - BT3™ Beta Titanium</b>		
Dimension	0° Torque	20° Torque
.017x.025	B3DYBU1725	B3DYBU1725TQ
.019x.025	B3DYBU1925	B3DYBU1925TQ
.020x.020	B3DYBU2020	B3DYBU2020TQ
<b>DYB™-V3 92% - BT3™ Beta Titanium</b>		
Dimension	0° Torque	20° Torque
.017x.025	B3DYB92U1725	B3DYB92U1725TQ
.019x.025	B3DYB92U1925	B3DYB92U1925TQ
.020x.020	B3DYB92U2020	B3DYB92U2020TQ
<b>DYB™-V3 - G4™ Nickel Titanium</b>		
Dimension	0° Torque	With Pre-Loaded Stops
.014	G4DYBU014	G4DYBU014CB
.016	G4DYBU016	G4DYBU016CB
.014x.025	G4DYBU1425	G4DYBU1425CB
.017x.025	G4DYBU1725	G4DYBU1725CB
.018x.018	G4DYBU1818	G4DYBU1818CB
.019x.025	G4DYBU1925	G4DYBU1925CB
.020x.020	G4DYBU2020	G4DYBU2020CB
<b>DYB™-V3 92% - G4™ Nickel Titanium</b>		
Dimension	0° Torque	With Pre-Loaded Stops
.014	G4DYB92U014	G4DYB92U014CB
.016	G4DYB92U016	G4DYB92U016CB
.014x.025	G4DYB92U1425	G4DYB92U1425CB
.017x.025	G4DYB92U1725	G4DYB92U1725CB
.018x.018	G4DYB92U1818	G4DYB92U1818CB
.019x.025	G4DYB92U1925	G4DYB92U1925CB
.020x.020	G4DYB92U2020	G4DYB92U2020CB

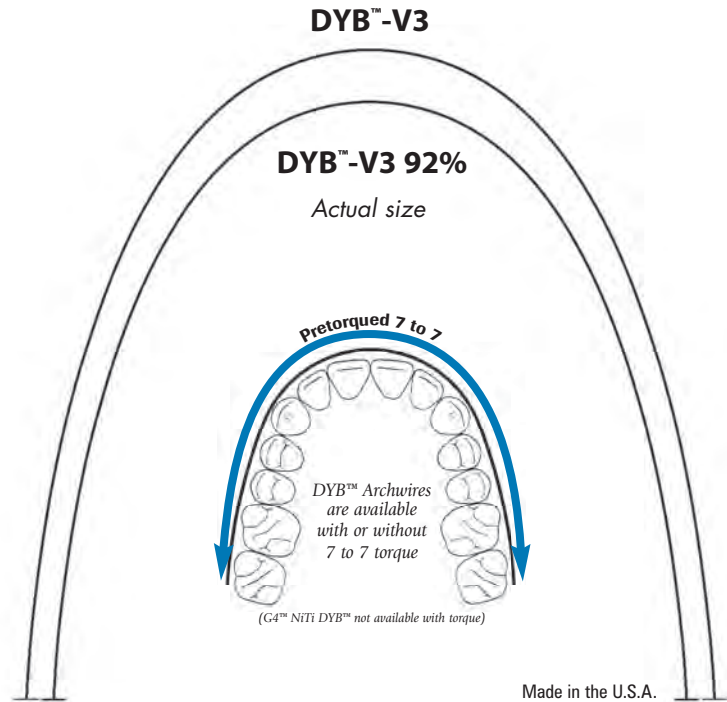

Other anterior pretorqued archwires also available - see pages 52 & 54 of the catalog or our website, [www.ghortho.com](http://www.ghortho.com)

Also available –

### DYB™ Europa™ II Archform – With or without torque, Damon-Compatible\*

<b>EF2 - S304 Stainless Steel</b>		
Dimension	0° Torque	15° Torque
.017x.025	S3EFU3725	S3EFU3725TQ
.019x.025	S3EFU3925	S3EFU3925TQ
.020x.020	S3EFU3020	S3EFU3020TQ
Package of 25, bulk pack		Package of 10, bulk pack
<b>EF2 - BT3™ Beta Titanium</b>		
Dimension	0° Torque	20° Torque
.017x.025	B3EFU3725	B3EFU3725TQ
.019x.025	B3EFU3925	B3EFU3925TQ
.020x.020	B3EFU3020	B3EFU3020TQ
Package of 10, bulk pack		Package of 10, bulk pack
<b>EF2 - G4™ Nickel Titanium</b>		
Dimension	0° Torque	
.017x.025	G4EFU3725	
.019x.025	G4EFU3925	
.020x.020	G4EFU3020	
Package of 25, bulk pack		



\*G&H™ Wire is in no way affiliated with or endorsed by Ormco Corporation or Dr. Dwight Damon

# Pre-Torqued G4™ NiTi

G&H®

## G4™ Pre-Torqued Nickel Titanium Archwires

Precision Manufactured By G&H® Orthodontics



G4™ Pre-torqued NiTi wires provide early and continuous translation of torque forces to anteriors. Effective on upper or lower arches, there is 20° of torque built into the anterior region of each wire. Torque forces can be applied labially or lingually by reversing the orientation of the wire. Three anterior mm sizes allow torque forces to be applied to upper or lower arch with choice of 3 wire sizes.



28mm Span = Lower    34 & 38mm Span = Upper

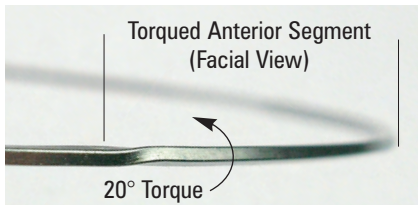

- 20° Torque applied only to centrals and laterals
- Clinically proven G4™ recovery forces applied in the 3rd Order
- Roots torque and parallel consistently
- Begin torque translation early in treatment
- 2 popular archform choices - Trueform™ I and Europa™ II
- Pre-Torqued also available in Reverse Curve - see page 54

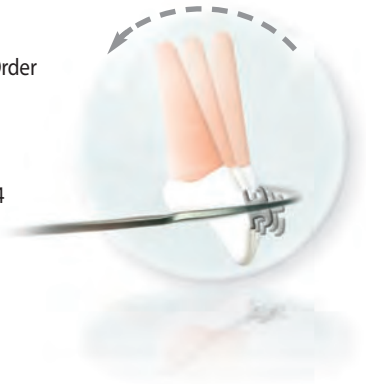

### Europa™ II & Trueform™ I Pre-Torqued Archform Notations

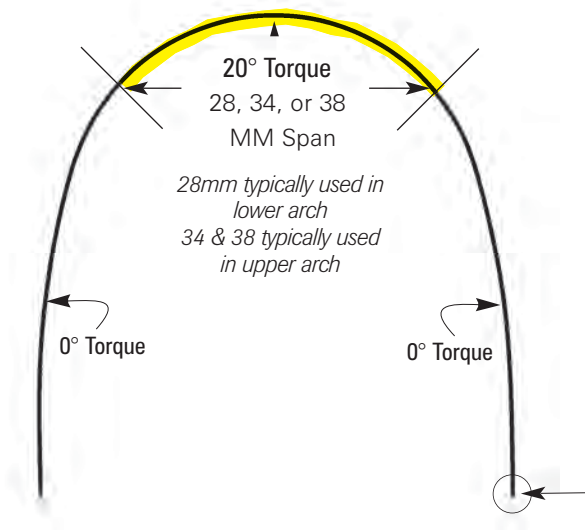

One end color coded:

- Red = 28mm (Lower)
- Blue = 34mm (Upper)
- Black = 38mm (Upper)

Color Mark Orientation:

As applied to the upper arch - 34 & 38mm

- Engage color to patient *right* for lingual root torque
- Engage color to patient *left* for labial root torque
- Reverse this orientation for lower arch (28mm) applications



All G4™ Pre-Torqued NiTi wires available with or without pre-loaded crimpable stops

Also available in Solo-Packs™

**Solo-Packs™** – 5 individually sealed autoclavable archwires per carton. For Solo-Pack™ wires, add "S" to the end of part number. Please allow 2-3 days for Solo-Pack™ packaging.



### G4™ Pre-Torqued NiTi Archwires

• 5/pack - Bulk Pack

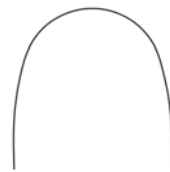

Trueform™ I Archform

#### Trueform™ I

Order No.	Description	Order No.
PTTF172528**	.017x.025 20° 28mm lwr.	PTEF372528**
PTTF172534**	.017x.025 20° 34mm upr.	PTEF372534**
PTTF172538**	.017x.025 20° 38mm upr.	PTEF372538**
PTTF192528**	.019x.025 20° 28mm lwr.	PTEF392528**
PTTF192534**	.019x.025 20° 34mm upr.	PTEF392534**
PTTF192538**	.019x.025 20° 38mm upr.	PTEF392538**
PTTF212528**	.021x.025 20° 28mm lwr.	N/A
PTTF212534**	.021x.025 20° 34mm upr.	N/A
PTTF212538**	.021x.025 20° 38mm upr.	N/A

Order Information:

- \*\* Add "S" for Solo-Pack (5 individually sealed wires)
- \*\* Add "CS" for Crimpable Stops + Solo-Pack
- \*\* Add "CB" for Crimpable Stops in Bulk Package of 5

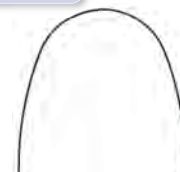

Europa™ II Damon-Compatible\* Universal Archform

Also available with pre-loaded crimpable stops

\*G&H® Wire is in no way affiliated with or endorsed by Ormco Corporation or Dr. Dwight Damon

## Reverse Curve NiTi

G&H®

### G4™ & M5™ Reverse Curve Nickel Titanium Archwires

Precision Manufactured By G&H® Orthodontics



Manufactured in both G4™ and M5™ NiTi formats, Reverse Curve wires provide excellent counter forces to achieve bite modifications quickly and efficiently, while also improving archform integrity.

#### Reverse Curve Nickel Titanium Archwires

• 10/pack - Bulk Pack

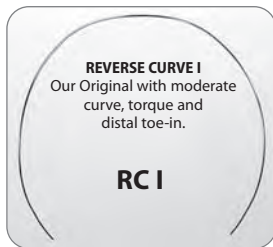

	Reverse Curve I			
	G4™ NiTi		M5™ Thermal	
	UPPER	LOWER	UPPER	LOWER
.012	G4RCU012	G4RCL012	M5RCU012	M5RCL012
.014	G4RCU014	G4RCL014	M5RCU014	M5RCL014
.016	G4RCU016	G4RCL016	M5RCU016	M5RCL016
.018	G4RCU018	G4RCL018	M5RCU018	M5RCL018
.020	G4RCU020	G4RCL020	M5RCU020	M5RCL020
.016x.016	G4RCU1616	G4RCL1616	M5RCU1616	M5RCL1616
.016x.022	G4RCU1622	G4RCL1622	M5RCU1622	M5RCL1622
.017x.017	G4RCU1717	G4RCL1717	M5RCU1717	M5RCL1717
.017x.025	G4RCU1725	G4RCL1725	M5RCU1725	M5RCL1725
.018x.018	G4RCU1818	G4RCL1818	M5RCU1818	M5RCL1818
.018x.025	G4RCU1825	G4RCL1825	M5RCU1825	M5RCL1825
.019x.025	G4RCU1925	G4RCL1925	M5RCU1925	M5RCL1925
.020x.020	G4RCU2020	G4RCL2020	M5RCU2020	M5RCL2020
.021x.025	G4RCU2125	G4RCL2125	M5RCU2125	M5RCL2125
	Reverse Curve III			
	G4™ NiTi		M5™ Thermal	
	UPPER	LOWER	UPPER	LOWER
.012	G4RCU3012	G4RCL3012	M5RCU3012	M5RCL3012
.014	G4RCU3014	G4RCL3014	M5RCU3014	M5RCL3014
.016	G4RCU3016	G4RCL3016	M5RCU3016	M5RCL3016
.018	G4RCU3018	G4RCL3018	M5RCU3018	M5RCL3018
.020	G4RCU3020	G4RCL3020	M5RCU3020	M5RCL3020
.016x.016	G4RCU31616	G4RCL31616	M5RCU31616	M5RCL31616
.016x.022	G4RCU31622	G4RCL31622	M5RCU31622	M5RCL31622
.017x.025	G4RCU31725	G4RCL31725	M5RCU31725	M5RCL31725
.018x.018	G4RCU31818	G4RCL31818	M5RCU31818	M5RCL31818
.018x.025	G4RCU31825	G4RCL31825	M5RCU31825	M5RCL31825
.019x.025	G4RCU31925	G4RCL31925	M5RCU31925	M5RCL31925
.020x.020	G4RCU32020	G4RCL32020	M5RCU32020	M5RCL32020
.021x.025	G4RCU32125	G4RCL32125	M5RCU32125	M5RCL32125



Tooth-Colored RCI available on page 60

Order Information:

**Standard Pack** – 10 archwires/pack

**Solo-Packs™**

– 10 individually sealed autoclavable archwires per carton.

For Solo-Pack™ wires, add "S" to the end of part number.

For Dimpled Midline (Narrow Dimple), add "D" to the end of part number.

For Dimpled Midlines in Solo-Pack™ (Narrow Dimple), add "DS" to the end of part number.

Note: Dimple not available in Thermal NiTi RC or RCI.

Please allow 2-3 days for Solo-Pack™ packaging.



Europa™II Reverse Curve also available with pre-loaded crimpable stops



#### G4™ Reverse Curve Europa™ II

Damon®-Compatible

• 10/pack - Bulk Pack

	Upper	Lower
.013	G4RCD113**	N/A
.014	G4RCD114**	N/A
.016	G4RCD116**	N/A
.018	G4RCD118**	N/A
.014x.025	G4RCD3425**	G4RCM3425**
.016x.016	G4RCD3616**	N/A
.016x.025	G4RCD3625**	N/A
.017x.017	G4RCD3717**	N/A
.017x.025	G4RCD3725**	N/A
.018x.018	G4RCD3818**	N/A
.018x.025	G4RCD3825**	G4RCM3825**
.019x.025	G4RCD3925**	N/A
.020x.020	G4RCD3020**	N/A

Order Information - Europa™II Reverse Curve:

**Standard Pack** – 10 archwires/pack

**Solo-Packs™**

– 10 individually sealed autoclavable archwires per carton.

\*\*For Solo-Pack™ wires, add "S" to the end of part number.

\*\*For Crimpable Stops + Solo-Pack™, add "CS" to the end of part number.

\*\*For Crimpable Stops in bulk package, add "CB" to the end of part number.

Please note stops are not available on G4RCM3425 and G4RCM3825.

Please allow 2-3 days for Solo-Pack™ packaging.

\*G&H® Wire is in no way affiliated with or endorsed by Ormco Corporation or Dr. Dwight Damon

# Reverse Curve Pre-torqued G4™ NiTi

G&H®

## G4™ Pre-Torqued Reverse Curve Nickel Titanium Archwires

Precision Manufactured By G&H® Orthodontics



**Reverse Curve NiTi** wires with 20° pre-torqued anterior segments increase torque control during intrusion. Lingual root torque is applied in upper archwires. Lower wires offer the choice of lingual or labial root torque.



28mm Span = Lower    34 & 38mm Span = Upper

### Pre-Torqued Reverse Curve I & Europa™ II Reverse Curve Archform Notations

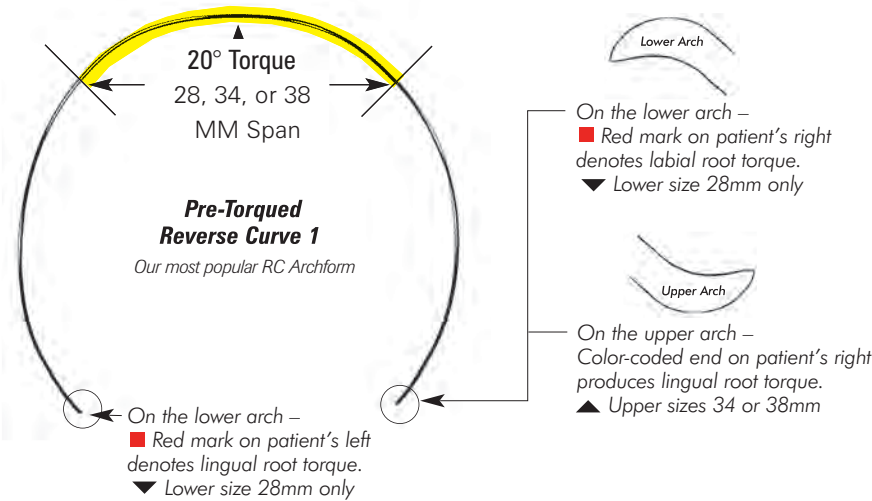

### Reverse Curve Pre-Torqued Available in 2 Archforms

#### Reverse Curve 1

- Mild toe-in bends
- Our most popular

#### Europa™ II

- No toe-in bends
- Damon\*-Compatible archform
- Available with or without pre-loaded crimpable stops



### G4™ Reverse Curve Pre-Torqued NiTi Archwires

• 5/pack - Bulk Pack



Reverse Curve I Archform  
Our most popular RC Archform

#### Reverse Curve I

Order No.	Description
RC1B172528*	.017x.025 20° 28mm lwr. Labial Root Torque
RC1G172528*	.017x.025 20° 28mm lwr. Lingual Root Torque
RC1G172534*	.017x.025 20° 34mm upr. Lingual Root Torque
RC1G172538*	.017x.025 20° 38mm upr. Lingual Root Torque
RC1B192528*	.019x.025 20° 28mm lwr. Labial Root Torque
RC1G192528*	.019x.025 20° 28mm lwr. Lingual Root Torque
RC1G192534*	.019x.025 20° 34mm upr. Lingual Root Torque
RC1G192538*	.019x.025 20° 38mm upr. Lingual Root Torque
RC1B212528*	.021x.025 20° 28mm lwr. Labial Root Torque
RC1G212528*	.021x.025 20° 28mm lwr. Lingual Root Torque
RC1G212534*	.021x.025 20° 34mm upr. Lingual Root Torque
RC1G212538*	.021x.025 20° 38mm upr. Lingual Root Torque

Order Information: Reverse Curve I

Standard Pack - 5 archwires/pack

\* Add "S" for Solo-Pack (5 individually sealed wires)  
(Please allow 2-3 days for Solo-Pack™ packaging)

Damon\*-Compatible

#### Reverse Curve Europa™ II

Order No.

RCDB172528**	
RCDG172528**	
RCDG172534**	
RCDG172538**	
RCDB192528**	
RCDG192528**	
RCDG192534**	
RCDG192538**	
RCDB212528**	
RCDG212528**	
RCDG212534**	
RCDG212538**	

Order Information: Europa™ II Reverse Curve

Standard Pack - 5 archwires/pack

\*\* Add "S" for Solo-Pack (5 individually sealed wires)  
\*\* Add "CS" for Crimpable Stops + Solo-Pack  
\*\* Add "CB" for Crimpable Stops in Bulk Package of 5

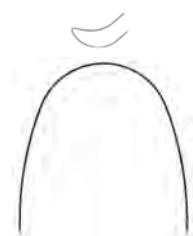

Europa™ II Reverse Curve Damon\*-Compatible Universal Archform

Also available with pre-loaded crimpable stops (.021x.025 not available with stops)

\*G&H® Wire is in no way affiliated with or endorsed by Ormco Corporation or Dr. Dwight Damon



## Beta Titanium Archwires

G&H®

### BT3™ Beta Titanium Archwires

Precision Manufactured By G&H® Orthodontics



### The moderate force alternative to Stainless Steel Archwires. — Nickel-Free

Our BT3™ Beta Titanium alloy provides force levels that are 45% less than those of equivalent stainless steel arches. BT3™ is the Beta Titanium III alloy representing the latest material science available in Titanium Molybdenum archwires. BT3™ wire is nickel-free.

### BT3™ Beta Titanium Archwires - Archform chart on page 37

• 10/pack - Bulk Pack

	Trueform™ I		Standard Form		Europa™ I		Europa™ II		Bioform III	
	UPPER	LOWER	UPPER	LOWER	UPPER	LOWER	UPPER	LOWER	UPPER	LOWER
.016	B3TFU016	B3TFL016	B3SFU016	B3SFL016	N/A	N/A	N/A	N/A	N/A	N/A
.018	B3TFU018	B3TFL018	B3SFU018	B3SFL018	N/A	N/A	N/A	N/A	N/A	N/A
.016x.016	B3TFU1616	B3TFL1616	B3SFU1616	B3SFL1616	N/A	N/A	N/A	N/A	N/A	N/A
.016x.022	B3TFU1622	B3TFL1622	B3SFU1622	B3SFL1622	B3EFU1622	B3EFL1622	B3EFU3622	B3EFL3622	B3BF3U1622	B3BF3L1622
.017x.025	B3TFU1725	B3TFL1725	B3SFU1725	B3SFL1725	B3EFU1725	B3EFL1725	B3EFU3725	B3EFL3725	B3BF3U1725	B3BF3L1725
.0175x.0175	B3TFU7575	B3TFL7575	B3SFU7575	B3SFL7575	N/A	N/A	N/A	N/A	N/A	N/A
.018x.025	B3TFU1825	B3TFL1825	B3SFU1825	B3SFL1825	N/A	N/A	N/A	N/A	N/A	N/A
.019x.025	B3TFU1925	B3TFL1925	B3SFU1925	B3SFL1925	B3EFU1925	B3EFL1925	B3EFU3925	B3EFL3925	B3BF3U1925	B3BF3L1925
.020x.020	N/A	N/A	N/A	N/A	N/A	N/A	B3EFU3020	B3EFL3020	N/A	N/A
.021x.025	B3TFU2125	B3TFL2125	B3SFU2125	B3SFL2125	N/A	N/A	B3EFU3125	B3EFL3125	N/A	N/A

Damon®-Compatible

Beta Titanium Straight Lengths appear on page 65

Order Information:

**Standard Pack** – 10 archwires/pack

**Solo-Packs™**

– 10 individually sealed autoclavable archwires per carton. For Solo-Pack™ wires, add "S" to the end of part number. Please allow 2-3 days for Solo-Pack™ packaging.



### BT3™ T-Loop

Our BT3™ Beta Titanium alloy is also available in a T-Loop archform.

**BT3™ T-Loop** LOWER 24 to 32mm / UPPER 34 to 42mm

• 5/pack

**Trueform™ I, 2-Loop**

.016x.022	B3TL1622*
.017x.025	B3TL1725*
.019x.025	B3TL1925*



\*Insert preferred millimeter size, available in 2mm increments.

**BT3™ T-Loop Kit** B3TLK\*\*

50 wires plus dispenser and ruler

\*\*Insert preferred wire size. 34-42mm Upper; 24-32mm Lower

**BT3™ T-Loop Archwire Kit** of 50 wires size distribution

MM Sizes	24	26	28	30	32	34	36	38	40	42
T-Loop (quantity per size)	5	5	5	5	5	5	5	5	5	5

(Solo-Pack™ not available for Looped and Posted wires.)

Exclusively from G&H®!

**MM Ruler**

Our unique double-sided ruler features a hole to engage a post or hook making space measurement quick, easy and accurate! Box of 20.

**60mm Ruler**  
**80mm Ruler**

**RULERMG**  
**RULERMGG**



\*\*TMA is a registered trademark of Ormco Corporation

\*G&H® Wire is in no way affiliated with or endorsed by Ormco Corporation or Dr. Dwight Damon

# Stainless Steel Archwires

G&H®

## S304 Stainless Steel Archwires

Precision Manufactured By G&H® Orthodontics



G&H® uses only 304v medical grade stainless steel wire in forming these archwires. By acquiring our wire from the finest stainless steel processing houses, G&H® can assure its customers a product high in quality and consistent in performance. In addition, G&H® uses state of the art forming equipment which ensures product integrity, consistent performance characteristics and precise archforms. With over 35 years of wire forming experience, G&H® understands the intricacies and nature of archwire production and takes great pride in craftsmanship.

### S304 Stainless Steel Archwires - Archform chart on page 37

• 25/pack - Bulk Pack

Damon®-Compatible

Order Information:

**Standard Pack** – 25 archwires/pack

**Solo-Packs™**

– 10 individually sealed autoclavable archwires per carton. For Solo-Pack™ wires, add "S" to the end of part number. Please allow 2-3 days for Solo-Pack™ packaging.



	Trueform™ I		Trueform™ II		Europa™ I		Europa™ II	
	UPPER	LOWER	UPPER	LOWER	UPPER	LOWER	UPPER	LOWER
.012	S3TFU012	S3TFL012	S3TFU112	S3TFL112	S3EFU012	S3EFL012	S3EFU112	S3EFL112
.014	S3TFU014	S3TFL014	S3TFU114	S3TFL114	S3EFU014	S3EFL014	S3EFU114	S3EFL114
.016	S3TFU016	S3TFL016	S3TFU116	S3TFL116	S3EFU016	S3EFL016	S3EFU116	S3EFL116
.018	S3TFU018	S3TFL018	S3TFU118	S3TFL118	S3EFU018	S3EFL018	S3EFU118	S3EFL118
.020	S3TFU020	S3TFL020	S3TFU120	S3TFL120	S3EFU020	S3EFL020	S3EFU120	S3EFL120
.016x.016	S3TFU1616	S3TFL1616	S3TFU3616	S3TFL3616	S3EFU1616	S3EFL1616	S3EFU3616	S3EFL3616
.016x.022	S3TFU1622	S3TFL1622	S3TFU3622	S3TFL3622	S3EFU1622	S3EFL1622	S3EFU3622	S3EFL3622
.016x.025	S3TFU1625	N/A	N/A	N/A	S3EFU1625	S3EFL1625	S3EFU3625	S3EFL3625
.017x.017	S3TFU1717	S3TFL1717	S3TFU3717	S3TFL3717	S3EFU1717	S3EFL1717	S3EFU3717	S3EFL3717
.017x.022	S3TFU1722	S3TFL1722	S3TFU3722	S3TFL3722	S3EFU1722	S3EFL1722	S3EFU3722	S3EFL3722
.017x.025	S3TFU1725	S3TFL1725	S3TFU3725	S3TFL3725	S3EFU1725	S3EFL1725	S3EFU3725	S3EFL3725
.018x.018	S3TFU1818	S3TFL1818	S3TFU3818	S3TFL3818	S3EFU1818	S3EFL1818	S3EFU3818	S3EFL3818
.018x.022	S3TFU1822	S3TFL1822	S3TFU3822	S3TFL3822	S3EFU1822	S3EFL1822	S3EFU3822	S3EFL3822
.018x.025	S3TFU1825	S3TFL1825	S3TFU3825	S3TFL3825	S3EFU1825	S3EFL1825	S3EFU3825	S3EFL3825
.019x.019	S3TFU1919	S3TFL1919	S3TFU3919	S3TFL3919	S3EFU1919	S3EFL1919	S3EFU3919	S3EFL3919
.019x.025	S3TFU1925	S3TFL1925	S3TFU3925	S3TFL3925	S3EFU1925	S3EFL1925	S3EFU3925	S3EFL3925
.020x.020	S3TFU2020	S3TFL2020	S3TFU3020	S3TFL3020	S3EFU2020	S3EFL2020	S3EFU3020	S3EFL3020
.021x.025	S3TFU2125	S3TFL2125	S3TFU3125	S3TFL3125	S3EFU2125	S3EFL2125	S3EFU3125	S3EFL3125

### S304 Stainless Steel Archwires - Cont.

	Standard Form		Bioform I	Bioform II	Bioform III		Bioform IV	Bioform V
	UPPER	LOWER			UPPER	LOWER		
.012	S3SFU012	S3SFL012	S3BF112	S3BF212	S3BF3U012	S3BF3L012	S3BF412	S3BF512
.014	S3SFU014	S3SFL014	S3BF114	S3BF214	S3BF3U014	S3BF3L014	S3BF414	S3BF514
.016	S3SFU016	S3SFL016	S3BF116	S3BF216	S3BF3U016	S3BF3L016	S3BF416	S3BF516
.018	S3SFU018	S3SFL018	S3BF118	S3BF218	S3BF3U018	S3BF3L018	S3BF418	S3BF518
.020	S3SFU020	S3SFL020	S3BF120	S3BF220	S3BF3U020	S3BF3L020	S3BF420	S3BF520
.016x.016	S3SFU1616	S3SFL1616	S3BF11616	S3BF21616	S3BF3U1616	S3BF3L1616	S3BF41616	S3BF51616
.016x.022	S3SFU1622	S3SFL1622	S3BF11622	S3BF21622	S3BF3U1622	S3BF3L1622	S3BF41622	S3BF51622
.017x.017	S3SFU1717	S3SFL1717	S3BF11717	S3BF21717	S3BF3U1717	S3BF3L1717	S3BF41717	S3BF51717
.017x.022	S3SFU1722	S3SFL1722	S3BF11722	S3BF21722	S3BF3U1722	S3BF3L1722	S3BF41722	S3BF51722
.017x.025	S3SFU1725	S3SFL1725	S3BF11725	S3BF21725	S3BF3U1725	S3BF3L1725	S3BF41725	S3BF51725
.018x.018	S3SFU1818	S3SFL1818	S3BF11818	S3BF21818	S3BF3U1818	S3BF3L1818	S3BF41818	S3BF51818
.018x.022	S3SFU1822	S3SFL1822	S3BF11822	S3BF21822	S3BF3U1822	S3BF3L1822	S3BF41822	S3BF51822
.018x.025	S3SFU1825	S3SFL1825	S3BF11825	S3BF21825	S3BF3U1825	S3BF3L1825	S3BF41825	S3BF51825
.019x.019	S3SFU1919	S3SFL1919	S3BF11919	S3BF21919	S3BF3U1919	S3BF3L1919	S3BF41919	S3BF51919
.019x.025	S3SFU1925	S3SFL1925	S3BF11925	S3BF21925	S3BF3U1925	S3BF3L1925	S3BF41925	S3BF51925
.020x.020	S3SFU2020	S3SFL2020	S3BF12020	S3BF22020	S3BF3U2020	S3BF3L2020	S3BF42020	S3BF52020
.021x.025	S3SFU2125	S3SFL2125	S3BF12125	S3BF22125	S3BF3U2125	S3BF3L2125	S3BF42125	S3BF52125

Stainless Steel Straight Lengths appear on page 65

\*G&H® Wire is in no way affiliated with or endorsed by Ormco Corporation or Dr. Dwight Damon

## Heat-Treated Stainless Steel Archwires

G&H®

### XR1™ Heat-Treated Stainless Steel Archwires

Precision Manufactured By G&H® Orthodontics



Our new **XR1™ Stainless Steel** is uniquely heat-treated and stress-relieved – increasing the resiliency of the wire to improve mechanics. G&H® uses state of the art forming equipment which ensures product integrity, consistent performance characteristics and precise archforms. With over 35 years of wire forming experience, G&H® understands the intricacies and nature of archwire production and takes great pride in craftsmanship.



#### XR1™ Heat-Treated Stainless Steel Archwires - Archform chart on page 37

• 25/pack - Bulk Pack

Damon™-Compatible

	Trueform™ I		Trueform™ II		Europa™ I		Europa™ II	
	UPPER	LOWER	UPPER	LOWER	UPPER	LOWER	UPPER	LOWER
.012	XRTFU012	XRTFL012	XRTFU112	XRTFL112	XREFU012	XREFL012	XREFU112	XREFL112
.014	XRTFU014	XRTFL014	XRTFU114	XRTFL114	XREFU014	XREFL014	XREFU114	XREFL114
.016	XRTFU016	XRTFL016	XRTFU116	XRTFL116	XREFU016	XREFL016	XREFU116	XREFL116
.018	XRTFU018	XRTFL018	XRTFU118	XRTFL118	XREFU018	XREFL018	XREFU118	XREFL118
.020	XRTFU020	XRTFL020	XRTFU120	XRTFL120	XREFU020	XREFL020	XREFU120	XREFL120
.016x.016	XRTFU1616	XRTFL1616	XRTFU3616	XRTFL3616	XREFU1616	XREFL1616	XREFU3616	XREFL3616
.016x.022	XRTFU1622	XRTFL1622	XRTFU3622	XRTFL3622	XREFU1622	XREFL1622	XREFU3622	XREFL3622
.016x.025	N/A	N/A	N/A	N/A	XREFU1625	XREFL1625	XREFU3625	XREFL3625
.017x.017	XRTFU1717	XRTFL1717	XRTFU3717	XRTFL3717	XREFU1717	XREFL1717	XREFU3717	XREFL3717
.017x.022	XRTFU1722	XRTFL1722	XRTFU3722	XRTFL3722	XREFU1722	XREFL1722	XREFU3722	XREFL3722
.017x.025	XRTFU1725	XRTFL1725	XRTFU3725	XRTFL3725	XREFU1725	XREFL1725	XREFU3725	XREFL3725
.018x.018	XRTFU1818	XRTFL1818	XRTFU3818	XRTFL3818	XREFU1818	XREFL1818	XREFU3818	XREFL3818
.018x.022	XRTFU1822	XRTFL1822	XRTFU3822	XRTFL3822	XREFU1822	XREFL1822	XREFU3822	XREFL3822
.018x.025	XRTFU1825	XRTFL1825	XRTFU3825	XRTFL3825	XREFU1825	XREFL1825	XREFU3825	XREFL3825
.019x.025	XRTFU1925	XRTFL1925	XRTFU3925	XRTFL3925	XREFU1925	XREFL1925	XREFU3925	XREFL3925
.020x.020	XRTFU2020	XRTFL2020	XRTFU3020	XRTFL3020	XREFU2020	XREFL2020	XREFU3020	XREFL3020
.021x.025	XRTFU2125	XRTFL2125	XRTFU3125	XRTFL3125	XREFU2125	XREFL2125	XREFU3125	XREFL3125

Order Information:

**Standard Pack** – 25 archwires/pack

**Solo-Packs™**

– 10 individually sealed autoclavable archwires per carton. For Solo-Pack™ wires, add "S" to the end of part number. Please allow 2-3 days for Solo-Pack™ packaging.



#### XR1™ Heat-Treated Stainless Steel Archwires - Cont.

	Standard Form		Bioform I	Bioform II	Bioform III		Bioform IV	Bioform V
	UPPER	LOWER			UPPER	LOWER		
.012	XRSFU012	XRSFL012	XRBF112	XRBF212	XRBF3U012	XRBF3L012	XRBF412	XRBF512
.014	XRSFU014	XRSFL014	XRBF114	XRBF214	XRBF3U014	XRBF3L014	XRBF414	XRBF514
.016	XRSFU016	XRSFL016	XRBF116	XRBF216	XRBF3U016	XRBF3L016	XRBF416	XRBF516
.018	XRSFU018	XRSFL018	XRBF118	XRBF218	XRBF3U018	XRBF3L018	XRBF418	XRBF518
.020	XRSFU020	XRSFL020	XRBF120	XRBF220	XRBF3U020	XRBF3L020	XRBF420	XRBF520
.016x.016	XRSFU1616	XRSFL1616	XRBF11616	XRBF21616	XRBF3U1616	XRBF3L1616	XRBF41616	XRBF51616
.016x.022	XRSFU1622	XRSFL1622	XRBF11622	XRBF21622	XRBF3U1622	XRBF3L1622	XRBF41622	XRBF51622
.017x.017	XRSFU1717	XRSFL1717	XRBF11717	XRBF21717	XRBF3U1717	XRBF3L1717	XRBF41717	XRBF51717
.017x.022	XRSFU1722	XRSFL1722	XRBF11722	XRBF21722	XRBF3U1722	XRBF3L1722	XRBF41722	XRBF51722
.017x.025	XRSFU1725	XRSFL1725	XRBF11725	XRBF21725	XRBF3U1725	XRBF3L1725	XRBF41725	XRBF51725
.018x.018	XRSFU1818	XRSFL1818	XRBF11818	XRBF21818	XRBF3U1818	XRBF3L1818	XRBF41818	XRBF51818
.018x.022	XRSFU1822	XRSFL1822	XRBF11822	XRBF21822	XRBF3U1822	XRBF3L1822	XRBF41822	XRBF51822
.018x.025	XRSFU1825	XRSFL1825	XRBF11825	XRBF21825	XRBF3U1825	XRBF3L1825	XRBF41825	XRBF51825
.019x.025	XRSFU1925	XRSFL1925	XRBF11925	XRBF21925	XRBF3U1925	XRBF3L1925	XRBF41925	XRBF51925
.020x.020	XRSFU2020	XRSFL2020	XRBF12020	XRBF22020	XRBF3U2020	XRBF3L2020	XRBF42020	XRBF52020
.021x.025	XRSFU2125	XRSFL2125	XRBF12125	XRBF22125	XRBF3U2125	XRBF3L2125	XRBF42125	XRBF52125

\*G&H® Wire is in no way affiliated with or endorsed by Ormco Corporation or Dr. Dwight Damon

# Looped Archwires

G&H®

## Stainless Steel Looped Archwires

Precision Manufactured By G&H® Orthodontics



G&H's looped retraction arches are individually formed to exacting standards. Our looped archwires are available in stainless steel as listed on this page and in BT3™ Beta Titanium (page 55). Keyhole Loops and T-Loops allow clinicians a choice of designs. These loops make a stainless (or Beta Titanium) archwire a multipurpose treatment adjunct that can achieve various intraoral objectives, often simultaneously. Such objectives can include:

- Friction-free segmented retraction
- Opening or closing spaces
- Intruding or extruding anterior teeth
- Opening or closing the bite
- Leveling the Curve of Spee
- Engaging Class I, II, III or up-and-down elastics
- Torquing the anterior or posterior teeth
- Attaching J-hooks for headgear in retracting anterior teeth

■ To select a proper size looped arch, measure along incisal edge from distal of lateral to distal of opposite lateral with a mm ruler. (Rulers below)

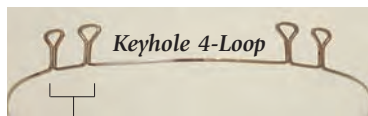
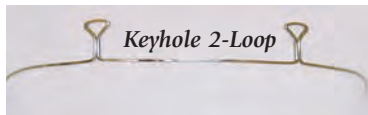

Paired Loop Spacing – 6.5mm Lower, 8mm Upper



Also available in BT3™ Beta Titanium (page 55)

**Dr. Ron Roth said that for retraction, a stainless loop should be activated by expanding it the "width of one thin dime."**



### Tech Tip for Looped & Posted Wires:

To apply anterior torque, hold the loop or post by straddling it with a Rose Torquing Plier. Apply 3rd order bends with a second plier to the anterior segment without distorting the loop or post.



Exclusively from G&H®!

### MM Ruler

Our unique double-sided ruler features a hole to engage a post or hook making space measurement quick, easy and accurate.

20/Box

**60mm Ruler**  
**80mm Ruler**

**RULERMG**  
**RULERMGG**

Looped sizes  
28mm (Lower) &  
36mm (Upper)  
are used the most.

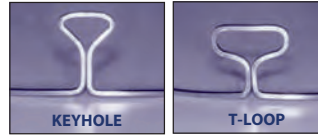

### Keyhole

•10/pack

	Trueform™ I	
	2 LOOP	4 LOOP
.016x.022	KHTF21622*	KHTF41622*
.017x.025	KHTF21725*	KHTF41725*
.019x.025	KHTF21925*	KHTF41925*

\*Insert preferred millimeter size, available in 2mm increments - Upper = 34mm to 44mm / Lower = 22mm to 32mm.

Note: .016x.022 Standard Form • 2-Loop - 36 & 38mm - not available  
.017x.025 Standard Form • 2-Loop - 26 & 28mm - not available  
.016x.022 Standard Form • 4-Loop - 32mm - not available

**Keyhole Kit** KHTFK2\*\* KHTFK4\*\*

\*\*Insert preferred wire size - Kit includes 100 wires plus dispenser and ruler.

Note: .020 & .017x.025 - Standard Form • 2-Loop - Kits not available  
.016x.016, .016x.022, .017x.025, .018x.025, .019x.025 - Trueform • 2-Loop - Kits not available  
.016x.022 & .021x.025 - Standard Form • 4-Loop - Kits not available  
.016x.022, .017x.025 & .019x.025 - Trueform • 4-Loop - Kits not available

### T-Loop

•10/pack

	Trueform™ I
	2 LOOP
.016x.022	TLTF1622*
.017x.025	TLTF1725*
.019x.025	TLTF1925*

\*Insert preferred millimeter size, available in 2mm increments - Upper = 36mm to 46mm / Lower = 24mm to 34mm.

Note: .016x.022 Standard Form - 38 & 46mm - not available

**T-Loop Kit** TLTFK\*\*

\*\*Insert preferred wire size - Kit includes 100 wires plus dispenser and ruler.

Note: .016x.022 & .019x.025 - Standard Form - Kits not available

### Looped Archwire Kit of 100 wires size distribution

MM Sizes	22	24	26	28	30	32	34	36	38	40	42	44	46
Keyhole (quantity per size)	5	5	10	10	10	5	10	10	10	10	10	5	N/A
T-Loop (quantity per size)	N/A	5	10	10	10	5	5	10	10	10	10	10	5

(Solo-Pack™ not available for Looped and Posted wires.)

## Posted Archwires

G&H®

### XR1™ Ball Post Archwires *The Only Brass Ball-End Posts Available! – Mounted On Heat-Treated Stainless Wires*

*Precision Manufactured By G&H® Orthodontics*



Our exclusive “XR1™ Ball Post archwires offer the comfort and retention of ball ends plus a bendable brass post. A G&H® proprietary soldering technique ensures clean, strong and consistent joints. The .016x.022, .016x.025 or .019x.025 XR1™ stainless base wire is heat-treated and stress relieved – increasing the resiliency of the wire to improve mechanics. Archforms available are Damon\*-compatible, MBT Ovoid, MBT Tapered, or Trueform™.

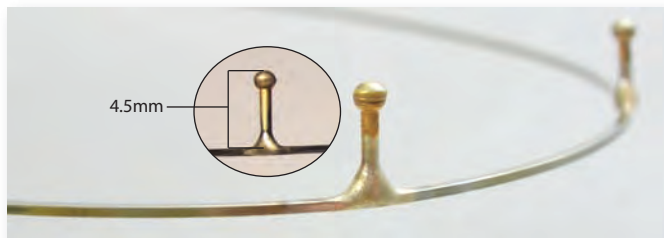

#### Ball Post Archwires

-10/pack

	Europa™ I (MBT Ovoid)	Bioform III (MBT Tapered)	Europa™ II Universal (Damon)	Trueform™ I (MBT Square)
.016x.022	N/A	PXBB31622*	N/A	PXBT1622*
.016x.025	N/A	N/A	PXBD3625*	N/A
.017x.025	PXBE1725*	PXBB31725*	N/A	N/A
.019x.025	PXBE1925*	PXBB31925*	PXBD3925*	PXBT1925*

\*Insert preferred millimeter size, available in 2mm increments - 22mm to 44mm.

#### Ball Post Kits

.016x.022	N/A	PXBB3K1622	N/A	PXBTK1622
.016x.025	N/A	N/A	PXBDK3625	N/A
.017x.025	PXBEK1725	PXBB3K1725	N/A	N/A
.019x.025	PXBEK1925	PXBB3K1925	PXBDK3925	PXBTK1925

Kit includes 100 wires plus dispenser and ruler.

#### Brass Ball-End Posts Provide

- Patient Comfort
- Maximum Retention
- Adaptability

#### G&H® Proprietary Solder Technique

- Strong, Secure & Smooth Joints
- No Archwire Annealing

#### XR1™ Heat-Treated Stainless Base Wire

- Increased Resiliency
- Minimizes Distortion

*Sizes  
28mm (Lower)  
& 36mm (Upper)  
are used the most.*

Posted Archwire Kit of 100 wires size distribution - Straight Post and Ball Post Kits

MM Sizes	22	24	26	28	30	32	34	36	38	40	42	44	46
Posted (quantity per size)	5	5	10	10	10	5	10	10	10	10	10	5	N/A

G&H®

### S304 Straight Post Archwires

*Precision Manufactured By G&H® Orthodontics*



Our straight post & ball end post stainless steel posted arches have .030" silver soldered brass posts. Sized in 2mm increments, upper archwires are available in 34 to 44 mm sizes, lower in 22 to 32mm.

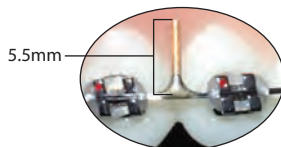

#### Straight Post Archwires

-10/pack

	Trueform™ I	Europa™ I	Europa™ II
.016	PSTF016*	PSEF016*	N/A
.018	PSTF018*	PSEF018*	N/A
.020	PSTF020*	PSEF020*	N/A
.016x.016	PSTF1616*	PSEF1616*	N/A
.016x.022	PSTF1622*	PSEF1622*	N/A
.016x.025	N/A	N/A	PSEF3625*
.017x.025	PSTF1725*	PSEF1725*	PSEF3725*
.018x.025	PSTF1825*	PSEF1825*	N/A
.019x.025	PSTF1925*	PSEF1925*	PSEF3925*
.020x.020	PSTF2020*	PSEF2020*	N/A
.021x.025	PSTF2125*	PSEF2125*	PSEF3125*

\*Insert preferred millimeter size, available in 2mm increments - Sizes 22mm to 44mm.

Kits	Trueform™ I	Europa™ I	Europa™ II
	PSTFK**	PSEFK**	.016x.025 PSEFK3625
			.017x.025 PSEFK3725
			.019x.025 PSEFK3925
			.021x.025 PSEFK3125

Kit includes 100 wires plus dispenser and ruler.

\*G&H® Wire is in no way affiliated with or endorsed by Ormco Corporation or Dr. Dwight Damon

# Tooth-Colored Archwires

G&H®

## Ultraesthetic™ Tooth-Colored Archwires - Epoxy Coated

Precision Manufactured By G&H® Orthodontics



Manufactured in both G4™ NiTi and S304 Stainless Steel. Tooth-Colored epoxy coated archwires necessitate the use of base wires that are .002" smaller than the final coated dimensions, so please consider this when selecting wires to ensure performance will be compatible with treatment objectives.



Order Information:

**Standard Pack** – 10 archwires/pack

**Solo-Packs™**

– 10 individually sealed autoclavable archwires per carton. For Solo-Pack™ wires, add "S" to the end of part number. Please allow 2-3 days for Solo-Pack™ packaging.



### Tooth-Colored G4™ Nickel Titanium Archwires – Archform chart on page 37

• 10/pack - Bulk Pack

Damon®-Compatible

	Trueform™ I		Europa™ I		Europa™ II		Bioform III	
	UPPER	LOWER	UPPER	LOWER	UPPER	LOWER	UPPER	LOWER
.012	G4TFU012T	G4TFL012T	G4EFU012T	G4EFL012T	G4EFU112T	G4EFL112T	G4BF3U012T	G4BF3L012T
.014	G4TFU014T	G4TFL014T	G4EFU014T	G4EFL014T	G4EFU114T	G4EFL114T	G4BF3U014T	G4BF3L014T
.016	G4TFU016T	G4TFL016T	G4EFU016T	G4EFL016T	G4EFU116T	G4EFL116T	G4BF3U016T	G4BF3L016T
.018	G4TFU018T	G4TFL018T	G4EFU018T	G4EFL018T	G4EFU118T	G4EFL118T	G4BF3U018T	G4BF3L018T
.020	G4TFU020T	G4TFL020T	G4EFU020T	G4EFL020T	G4EFU120T	G4EFL120T	G4BF3U020T	G4BF3L020T
.016x.022	G4TFU1622T	G4TFL1622T	G4EFU1622T	G4EFL1622T	G4EFU3622T	G4EFL3622T	G4BF3U1622T	G4BF3L1622T
.016x.027	N/A	N/A	N/A	N/A	G4EFU3627T	G4EFL3627T	N/A	N/A
.017x.025	G4TFU1725T	G4TFL1725T	G4EFU1725T	G4EFL1725T	G4EFU3725T	G4EFL3725T	G4BF3U1725T	G4BF3L1725T
.018x.018	G4TFU1818T	G4TFL1818T	G4EFU1818T	G4EFL1818T	G4EFU3818T	G4EFL3818T	G4BF3U1818T	G4BF3L1818T
.018x.025	G4TFU1825T	G4TFL1825T	G4EFU1825T	G4EFL1825T	G4EFU3825T	G4EFL3825T	G4BF3U1825T	G4BF3L1825T
.019x.025	G4TFU1925T	G4TFL1925T	G4EFU1925T	G4EFL1925T	G4EFU3925T	G4EFL3925T	G4BF3U1925T	G4BF3L1925T
.020x.020	G4TFU2020T	G4TFL2020T	G4EFU2020T	G4EFL2020T	G4EFU3020T	G4EFL3020T	G4BF3U2020T	G4BF3L2020T
.021x.025	G4TFU2125T	G4TFL2125T	G4EFU2125T	G4EFL2125T	G4EFU3125T	G4EFL3125T	G4BF3U2125T	G4BF3L2125T

### Tooth-Colored S304 Stainless Steel Archwires – Archform chart on page 37

• 25/pack - Bulk Pack

Damon®-Compatible

	Trueform™ I		Europa™ I		Europa™ II		Bioform III	
	UPPER	LOWER	UPPER	LOWER	UPPER	LOWER	UPPER	LOWER
.014	S3TFU014T	S3TFL014T	S3EFU014T	S3EFL014T	S3EFU114T	S3EFL114T	S3BF3U014T	S3BF3L014T
.016	S3TFU016T	S3TFL016T	S3EFU016T	S3EFL016T	S3EFU116T	S3EFL116T	S3BF3U016T	S3BF3L016T
.018	S3TFU018T	S3TFL018T	S3EFU018T	S3EFL018T	S3EFU118T	S3EFL118T	S3BF3U018T	S3BF3L018T
.020	S3TFU020T	S3TFL020T	S3EFU020T	S3EFL020T	S3EFU120T	S3EFL120T	S3BF3U020T	S3BF3L020T
.016x.022	S3TFU1622T	S3TFL1622T	S3EFU1622T	S3EFL1622T	S3EFU3622T	S3EFL3622T	S3BF3U1622T	S3BF3L1622T
.017x.025	S3TFU1725T	S3TFL1725T	S3EFU1725T	S3EFL1725T	S3EFU3725T	S3EFL3725T	S3BF3U1725T	S3BF3L1725T
.018x.018	S3TFU1818T	S3TFL1818T	S3EFU1818T	S3EFL1818T	S3EFU3818T	S3EFL3818T	S3BF3U1818T	S3BF3L1818T
.018x.025	S3TFU1825T	S3TFL1825T	S3EFU1825T	S3EFL1825T	S3EFU3825T	S3EFL3825T	S3BF3U1825T	S3BF3L1825T
.019x.025	S3TFU1925T	S3TFL1925T	S3EFU1925T	S3EFL1925T	S3EFU3925T	S3EFL3925T	S3BF3U1925T	S3BF3L1925T
.020x.020	S3TFU2020T	S3TFL2020T	S3EFU2020T	S3EFL2020T	S3EFU3020T	S3EFL3020T	S3BF3U2020T	S3BF3L2020T
.021x.025	S3TFU2125T	S3TFL2125T	S3EFU2125T	S3EFL2125T	S3EFU3125T	S3EFL3125T	S3BF3U2125T	S3BF3L2125T

Order Information:

**Standard Pack** – 25 archwires/pack

**Solo-Packs™**

– 10 individually sealed autoclavable archwires per carton. For Solo-Pack™ wires, add "S" to the end of part number. Please allow 2-3 days for Solo-Pack™ packaging.



Tooth-colored archwires are ink midlined (black upper - red lower) for symmetrical identification. After archwire placement, rub midline gently with a cotton swab dipped in isopropyl alcohol—this will remove the majority of ink.

Order Information:

**Standard Pack** – 10 archwires/pack

**Solo-Packs™**

– 10 individually sealed autoclavable archwires per carton. For Solo-Pack™ wires, add "S" to the end of part number. Please allow 2-3 days for Solo-Pack™ packaging.



### Tooth-Colored Reverse Curve G4™ NiTi

• 10/pack - Bulk Pack

	Reverse Curve I	
	Upper	Lower
.012	G4RCU012T	G4RCU012T
.014	G4RCU014T	G4RCU014T
.016	G4RCU016T	G4RCU016T
.018	G4RCU018T	G4RCU018T
.020	G4RCU020T	G4RCU020T
.016x.022	G4RCU1622T	G4RCU1622T
.017x.025	G4RCU1725T	G4RCU1725T
.018x.018	G4RCU1818T	G4RCU1818T
.018x.025	G4RCU1825T	G4RCU1825T
.019x.025	G4RCU1925T	G4RCU1925T
.020x.020	G4RCU2020T	G4RCU2020T
.021x.025	G4RCU2125T	G4RCU2125T

## Lingual Archwires

G&H®

### Lingual Archwires - Preformed

Precision Manufactured By G&H® Orthodontics

G&H® proudly introduces a comprehensive line of Lingual Archwires developed to meet the challenging mechanics of modern lingual treatment. Archforms are designed and adapted precisely to lingual anatomy. Various alloys are offered to maximize treatment efficiencies in the narrow interbracket dimensions of lingual orthodontic treatment.

Nickel Titanium lingual wires are available in .010, .013, .016 G4™ NiTi for early engagement. M5™ (Thermal) NiTi wires in .016, .016x.022, .017x.017 or .017x.025 allow transitional sequencing. G4™ and M5™ Lingual Wires are produced in the popular “mushroom” shape lingual archform. Three anterior sizes in both uppers and lowers ensure a proper fit.

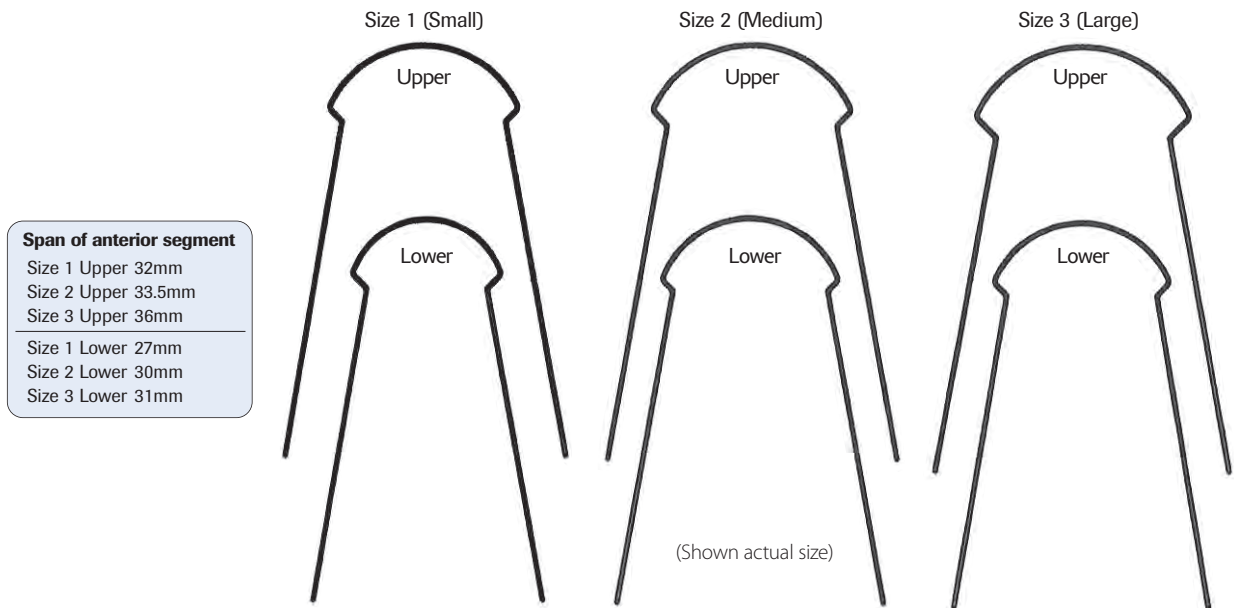

#### Pre-formed “Mushroom Shape” G4™ NiTi Lingual Arches

•2/pack		
G4™ Lingual Small (1) Upper	.010	G4LSU010
G4™ Lingual Medium (2) Upper	.010	G4LMU010
G4™ Lingual Large (3) Upper	.010	G4LLU010
G4™ Lingual Small (1) Lower	.010	G4LSL010
G4™ Lingual Medium (2) Lower	.010	G4LML010
G4™ Lingual Large (3) Lower	.010	G4LLL010
G4™ Lingual Small (1) Upper	.013	G4LSU013
G4™ Lingual Medium (2) Upper	.013	G4LMU013
G4™ Lingual Large (3) Upper	.013	G4LLU013
G4™ Lingual Small (1) Lower	.013	G4LSL013
G4™ Lingual Medium (2) Lower	.013	G4LML013
G4™ Lingual Large (3) Lower	.013	G4LLL013
G4™ Lingual Small (1) Upper	.016	G4LSU016
G4™ Lingual Medium (2) Upper	.016	G4LMU016
G4™ Lingual Large (3) Upper	.016	G4LLU016
G4™ Lingual Small (1) Lower	.016	G4LSL016
G4™ Lingual Medium (2) Lower	.016	G4LML016
G4™ Lingual Large (3) Lower	.016	G4LLL016

#### Pre-formed “Mushroom Shape” M5™ Thermal NiTi Lingual Arches

•2/pack		
M5™ Lingual Small (1) Upper	.016	M5LSU016
M5™ Lingual Medium (2) Upper	.016	M5LMU016
M5™ Lingual Large (3) Upper	.016	M5LLU016
M5™ Lingual Small (1) Lower	.016	M5LSL016
M5™ Lingual Medium (2) Lower	.016	M5LML016
M5™ Lingual Large (3) Lower	.016	M5LLL016
M5™ Lingual Small (1) Upper	.016x.022	M5LSU1622
M5™ Lingual Medium (2) Upper	.016x.022	M5LMU1622
M5™ Lingual Large (3) Upper	.016x.022	M5LLU1622
M5™ Lingual Small (1) Lower	.016x.022	M5LSL1622
M5™ Lingual Medium (2) Lower	.016x.022	M5LML1622
M5™ Lingual Large (3) Lower	.016x.022	M5LLL1622
M5™ Lingual Small (1) Upper	.017x.017	M5LSU1717
M5™ Lingual Medium (2) Upper	.017x.017	M5LMU1717
M5™ Lingual Large (3) Upper	.017x.017	M5LLU1717
M5™ Lingual Small (1) Lower	.017x.017	M5LSL1717
M5™ Lingual Medium (2) Lower	.017x.017	M5LML1717
M5™ Lingual Large (3) Lower	.017x.017	M5LLL1717
M5™ Lingual Small (1) Upper	.017x.025	M5LSU1725
M5™ Lingual Medium (2) Upper	.017x.025	M5LMU1725
M5™ Lingual Large (3) Upper	.017x.025	M5LLU1725
M5™ Lingual Small (1) Lower	.017x.025	M5LSL1725
M5™ Lingual Medium (2) Lower	.017x.025	M5LML1725
M5™ Lingual Large (3) Lower	.017x.025	M5LLL1725

#### Order Information:

**Standard Pack** – 2 archwires/pack

#### Solo-Packs™

– 2 individually sealed autoclavable archwires per carton. For Solo-Pack™ wires, add “S” to the end of part number. Please allow 2-3 days for Solo-Pack™ packaging.



# Lingual Archwires

G&H®

## Lingual Archwires - Universal

Precision Manufactured By G&H® Orthodontics

G&H® introduces a new universal Lingual Archwire developed from G4™ Nickel Titanium and BT3™ Beta Titanium. The universal archforms allow the clinician to apply the offset bends to adapt precisely to lingual anatomy.

The two alloys are offered to maximize treatment efficiencies in the narrow interbracket dimensions of lingual orthodontic treatment.

### G4™ NiTi Universal Lingual Archwires

•5/pack

	Small	Medium	Large	Ex-Large
.010	G4SLUN010	G4MLUN010	G4LLUN010	G4XLUN010
.012	G4SLUN012	G4MLUN012	G4LLUN012	G4XLUN012
.014	G4SLUN014	G4MLUN014	G4LLUN014	G4XLUN014
.016	G4SLUN016	G4MLUN016	G4LLUN016	G4XLUN016
.016x.022	N/A	N/A	N/A	G4XLUN1622
.017x.017	N/A	N/A	N/A	G4XLUN1717

### BT3™ Beta Titanium Universal Lingual Archwires

•5/pack

	Small	Medium	Large	Ex-Large
.016	B3SLUN016	B3MLUN016	B3LLUN016	B3XLUN016
.0175x.0175	B3SLUN17175	B3MLUN17175	B3LLUN17175	B3XLUN17175

Order Information:

**Standard Pack** – 5 archwires/pack

**Solo-Packs™**



– 5 individually sealed autoclavable archwires per carton. For Solo-Pack™ wires, add "S" to the end of part number. Please allow 2-3 days for Solo-Pack™ packaging.

Order Information:

**Standard Pack** – 5 archwires/pack

**Solo-Packs™**



– 5 individually sealed autoclavable archwires per carton. For Solo-Pack™ wires, add "S" to the end of part number. Please allow 2-3 days for Solo-Pack™ packaging.

Ex-Large

Large

Medium

Small

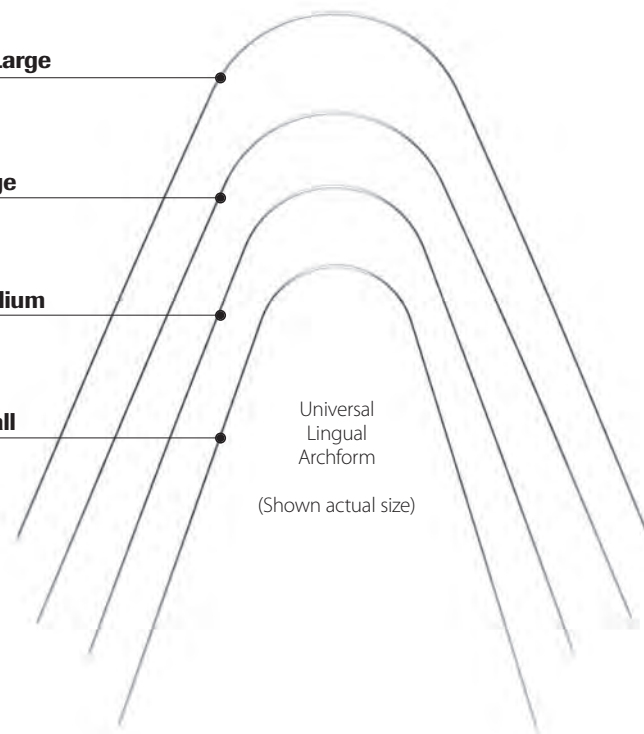

### NiTi Cinch-Back Plier

The NiTi Cinch-Back Plier is designed to place permanent offset bends in Nickel Titanium Archwires. The unique design provides access for cinch-back bends to wires distal to the buccal tubes on either side of the arch. 1st and 2nd order bends can also be made as desired anywhere on the archwire. **GH047**



### S304 Stainless Steel Universal Lingual Archwires

•5/pack

	Universal
.014	S3L014
.016	S3L016
.018	S3L018
.016x.022	S3L1622

### BT3™ Beta Titanium Universal Lingual Archwires

•5/pack

	Universal
.016	B3L016
.016x.022	B3L1622
.0175x.0175	B3L175175

Universal Archform

(Shown actual size)

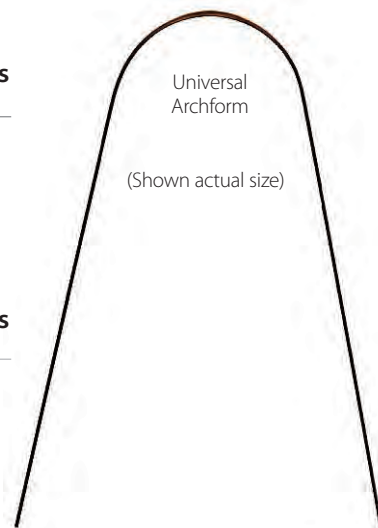



## Lingual Archwires



### A.J. Wilcock® Australian Combination Lingual Archwire

*World famous, never duplicated.*

#### A.J. Wilcock® Lingual Combination Archwires

Combination Archwires are rectangular in the anterior segment to maintain torque while the round posterior segments allow sliding mechanics with reduced friction.

A.J. Wilcock® Australian

#### Combination Lingual Archwires

**-2/pack**

Anterior .016x.022	Posterior .016	AW671-622*
Anterior .017x.025	Posterior .017	AW671-725*
Anterior .019x.025	Posterior .019	AW671-925*
Anterior .021x.025	Posterior .021	AW672-125*
Anterior .021x.027	Posterior .021	AW672-127*

#### Combination Lingual Archwire Kits

Sizes .016 to .019 (40 wires plus dispenser)	AW671-***KT
Sizes .021x.025 & .021x.027 (40 wires plus dispenser)	AW672-***KT

A.J. Wilcock® Combination Wires are not available in Solo-Pack™ packaging.



A.J. Wilcock® Australian Wire  
– See pages 67 & 68.

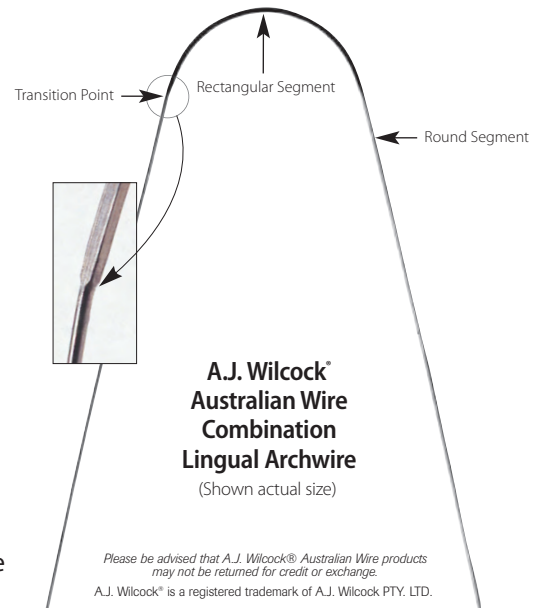

## Bonded Retainers

Wires of various alloys and dimensions are frequently used clinically to fabricate bonded lingual retainers. Below are some of the favorite choices of contemporary orthodontists.

### Multi-Strand Wire

The most popular wire for bonded lingual retainers, .0175 – 7-Strand (Twisted) stainless steel wire, available in 14" straight lengths or 30" spools.

See complete product details on page 64.



### Bond-A-Braid

#### Hilgers Bond-A-Braid

The dead-soft wire easily adapts and is excellent for semi-permanent orthodontic retention.

See complete product details on page 85.



### Fiber Reinforced Composites

#### • everStick® Ortho

See complete product details on page 96.



### Ortho-FlexTech™

#### Ortho-FlexTech™

The next generation in lingual retention: using solid gold or stainless steel chain retainer.

See complete product details on page 85.



### Adhesives

#### Flowtain®

Flowtain is a flowable light cured composite with low viscosity which makes it ideal for bonded lingual retainers and splints.

See complete product details on page 82.



#### LCR® Adhesive

LCR® is a light cure retainer adhesive.

See complete product details on page 82.



### Retanium™

Single strand nickel-free titanium flat metal ribbon is ideal for semi-permanent splinting and maintaining difficult extraction sites.

See complete product details on page 85.



### Wire Bonder/ Mini-Mold

Each mold is designed to pack with light cure adhesive, press against tooth, cure and peel away mold leaving a formed auxiliary on any tooth in just minutes.

See complete product details on page 91.



# Multi-Strand Stainless Steel Archwires

G&H®

## Multi-Strand Stainless Steel

Precision Manufactured By G&H® Orthodontics



Due to the gentle nature of the wire, **round stranded wires** are traditionally used in early treatment to correct misaligned teeth. Stranded wires apply a low force level over a given span with minor to moderate deformation depending on the severity of the malocclusion. **Rectangular stranded wires** are typically used in transitional applications to align and detail occlusions effectively with comparatively lower force than solid stainless steel archwires.



FORCE GRAPHS  
FOR ALL WIRES APPEAR ON  
PAGE 69

### Three Strand (Twisted)

Archforms and Straight Lengths •25/pack - Spools, Each

	Trueform™ I		Standard		14" Straight Lengths	30' Spools
	UPPER	LOWER	UPPER	LOWER		
.0155	N/A	N/A	CSFU155	CSFL155	MS3155	SST3155
.0175	N/A	N/A	CSFU175	CSFL175	MS3175	SST3175
.0195	N/A	N/A	CSFU195	CSFL195	MS3195	SST3195
.0215	N/A	N/A	CSFU215	CSFL215	MS3215	SST3215
.016x.016	CTFU1616	CTFL1616	CSFU1616	CSFL1616	MS3616	N/A
.016x.022	CTFU1622	CTFL1622	CSFU1622	CSFL1622	MS3622	N/A
.017x.025	CTFU1725	CTFL1725	CSFU1725	CSFL1725	MS3725	N/A
.018x.025	CTFU1825	CTFL1825	CSFU1825	CSFL1825	MS3825	N/A
.019x.025	CTFU1925	CTFL1925	CSFU1925	CSFL1925	MS3925	N/A

### Six Strand (Coaxial)

Archforms and Straight Lengths •25/pack - Spools, Each

	Standard		14" Straight Lengths	30' Spools
	UPPER	LOWER		
.0155	CSFU6155	CSFL6155	MS6155	SST6155
.0175	CSFU6175	CSFL6175	MS6175	SST6175
.0195	CSFU6195	CSFL6195	MS6195	SST6195
.0215	CSFU6215	CSFL6215	MS6215	SST6215

### Seven Strand (Twisted)

Archforms and Straight Lengths •25/pack - Spools, Each

	14" Straight Lengths	30' Spool
	.0155	MS7155
.0175	MS7175	SST7175
.0195	MS7195	SST7195
.0215	MS7215	SST7215

← .0175 Seven Strand is the most popular wire for bonded lingual retainers.

Order Information:

**Standard Pack** – 25 archwires/pack

**Solo-Packs™**

– 10 individually sealed autoclavable archwires per carton. For Solo-Pack™ wires, add "S" to the end of part number.

Please allow 2-3 days for Solo-Pack™ packaging.



### Eight Strand (Woven)

Archforms •25/pack

	Trueform™ I		Standard	
	UPPER	LOWER	UPPER	LOWER
.016x.016	CTFU8616	CTFL8616	CSFU8616	CSFL8616
.016x.022	CTFU8622	CTFL8622	CSFU8622	CSFL8622
.017x.025	CTFU8725	CTFL8725	CSFU8725	CSFL8725
.018x.025	CTFU8825	CTFL8825	CSFU8825	CSFL8825
.019x.025	CTFU8925	CTFL8925	CSFU8925	CSFL8925
.021x.025	CTFU8125	CTFL8125	CSFU8125	CSFL8125



EIGHT-STRAND  
STAINLESS STEEL

## Straight Lengths and Spools

G&H®

### Straight Lengths & Spooled Wire

Precision Manufactured By G&H® Orthodontics



#### Nickel Titanium Straight Lengths and Spools

are used for archwire and sectional applications.

#### Stainless Steel Straight Lengths

are manufactured from a 304v spring hard wire suitable for clinical and laboratory applications. Its superior resiliency resists deformation.

#### Beta Titanium Straight Lengths

provides the adaptability and handling characteristics of stainless steel with improved memory and gentler force levels, and its nickel-free alloy helps reduce patient sensitivity.

#### Colboly™ Blue Nickel Cobalt Wire

is an excellent choice for use in archwires, and is superb for use in removable and functional appliances.

#### Nickel Titanium Straight Lengths & Spools

Straight Lengths •10/tube - Spools, Each

7" Straight Lengths	15' Spool	
.010	SENT010	SESP010
.012	SENT012	SESP012
.014	SENT014	SESP014
.016	SENT016	SESP016
.018	SENT018	SESP018
.020	SENT020	SESP020
.014x.025	SENT1425	N/A
.016x.016	SENT1616	N/A
.016x.022	SENT1622	N/A
.016x.025	SENT1625	N/A
.017x.025	SENT1725	N/A
.018x.018	SENT1818	N/A
.018x.025	SENT1825	N/A
.019x.025	SENT1925	N/A
.020x.020	SENT2020	N/A
.021x.025	SENT2125	N/A

#### Stainless Steel Spring Tempered Wire

Straight Lengths •25/tube

14" Straight Lengths	
.012	STSS012
.014	STSS014
.016	STSS016
.018	STSS018
.020	STSS020
.022	STSS022
.024	STSS024
.026	STSS026
.028	STSS028
.030	STSS030
.032	STSS032
.036	STSS036
.040	STSS040
.045	STSS045
.051	STSS051
.016x.016	STSS1616
.016x.022	STSS1622
.017x.017	STSS1717
.017x.022	STSS1722
.017x.025	STSS1725
.018x.018	STSS1818
.018x.022	STSS1822
.018x.025	STSS1825
.019x.019	STSS1919
.019x.025	STSS1925
.020x.020	STSS2020
.021x.025	STSS2125

#### Beta Titanium

Straight Lengths •10/tube

14" Straight Lengths	
.016	STB3016
.018	STB3018
.028	STB3028
.032	STB3032
.036	STB3036
.016x.016	STB31616
.016x.022	STB31622
.017x.025	STB31725
.0175x.0175	STB37575
.018x.025	STB31825
.019x.025	STB31925
.021x.025	STB32125

#### Colboly™ Blue Nickel Cobalt

Straight Lengths •25/tube

14" Straight Lengths	
.014	STRCB014
.016	STRCB016
.018	STRCB018
.028	STRCB028
.030	STRCB030
.032	STRCB032
.036	STRCB036
.040	STRCB040
.045	STRCB045
.051	STRCB051
.016x.016	STRCB1616
.016x.022	STRCB1622
.017x.025	STRCB1725
.018x.025	STRCB1825
.019x.025	STRCB1925
.021x.025	STRCB2125



#### Soft Stainless Steel Wire

.016 annealed soft stainless steel wire is suitable for various applications including securing rapid palatal expander screws and ligating convertible tubes after cap removal.

Order Information:

15 ft. spool

**SSSOF016**



**Elastomeric Separators**  
See page 74

#### Niti Separating (NEET) Springs

offer efficient force for separating contact points prior to banding. Simple engagement and self activating.

Order Information:

.018" wire diameter, 20/pkg.

Bicuspid (Small)

**NEETSM20**

Molar (Large)

**NEETLG20**



**Ball Clasps** are excellent accessories for removable and fixed appliances. Spring hard temper maintains shape for snug fit.

Order Information:

1 1/2 inch overall length - 100/pack

.024 **SSBC024**

.028 **SSBC028**

.032 **SSBC032**

.036 **SSBC036**

.040 **SSBC040**



**Silver Solder** is cadmium and lead-free.

Order Information:

1/4 troy oz., .031 diameter

**SLVSLD**

# Nickel Cobalt and Ligature Wire

G&H®

## Colboly™ Blue - Nickel Cobalt Archwires

Precision Manufactured By G&H® Orthodontics

Colboly™ Blue Nickel Cobalt wire, like Elgiloy® wire, is a unique alloy. Colboly™ Blue allows intricate bending and, if desired, may be heat treated after formation to increase tensile strength and resiliency.

Order Information:

**Standard Pack** – 25 archwires/pack

**Solo-Packs™** – 10 individually sealed autoclavable archwires per carton. For Solo-Pack™ wires, add "S" to the end of part number. Please allow 2-3 days for Solo-Pack™ packaging.



### Colboly™ Blue Archwires

•25/pack

	Trueform™ I		Bioform I	Bioform III		Bioform V
	UPPER	LOWER	I	UPPER	LOWER	V
.014	CBTFU014	CBTFL014	CBBF114	CBBF3U014	CBBF3L014	CBBF514
.016	CBTFU016	CBTFL016	CBBF116	CBBF3U016	CBBF3L016	CBBF516
.018	CBTFU018	CBTFL018	CBBF118	CBBF3U018	CBBF3L018	CBBF518
.016x.016	CBTFU1616	CBTFL1616	CBBF1616	CBBF3U1616	CBBF3L1616	CBBF5616
.016x.022	CBTFU1622	CBTFL1622	CBBF1622	CBBF3U1622	CBBF3L1622	CBBF5622
.017x.022	CBTFU1722	CBTFL1722	N/A	N/A	N/A	N/A
.017x.025	CBTFU1725	CBTFL1725	CBBF1725	CBBF3U1725	CBBF3L1725	CBBF5725
.018x.025	CBTFU1825	CBTFL1825	CBBF1825	CBBF3U1825	CBBF3L1825	CBBF5825
.019x.025	CBTFU1925	CBTFL1925	CBBF1925	CBBF3U1925	CBBF3L1925	CBBF5925
.021x.025	CBTFU2125	CBTFL2125	N/A	N/A	N/A	N/A

## Stainless Steel Ligature Ties

### G&H® Koby Ties

Koby ties provide an auxiliary hook which can be added to any bracket just by tying in the archwire. They are preformed to be easily tied in place and able to fit most orthodontic brackets. Short ties have pre-wound pigtails for extra easy engagement and are made from easily adaptable .012 or .014 ligature wire. Tooth coated (.014) ties combine the strength and security of metal with the aesthetics needed for ceramic or composite brackets.



100/pkg.

	Long	Short
.010	<b>KH010</b>	.012 <b>SKH012</b>
.012	<b>KH012</b>	.014 <b>SKH014</b>
.014	<b>KH014</b>	.014 <b>TSKH014</b> (Tooth colored)

### Stainless Steel Ligature Ties

Preformed in dead soft temper.

#### Long

.008 (1,000/pkg.)	<b>LT008</b>
.009 (1,000/pkg.)	<b>LT009</b>
.010 (1,000/pkg.)	<b>LT010</b>
.011 (1,000/pkg.)	<b>LT011</b>
.012 (1,000/pkg.)	<b>LT012</b>
.012 (100/pkg, Tooth-Colored)	<b>TCLT012</b>
.014 (500/pkg.)	<b>LT014</b>



#### Pre-cut Ligature Ties

.008 Standard (500/pkg.)	<b>SLT008</b>
Applicable for lingual bracket engagement	
.010 Standard (500/pkg.)	<b>SLT010</b>
.012 Tooth color (50/pkg.)	<b>TCSLT012L</b>



### Spoiled Bulk Ligature Wire

Our spoiled ligature wire is diamond drawn to exacting dimension and features a bright finish with soft temper for ease of use.

1 lb. spool

.008 (5,827 ft.)	<b>SBLW108</b>
.009 (4,382 ft.)	<b>SBLW109</b>
.010 (3,730 ft.)	<b>SBLW110</b>
.011 (3,075 ft.)	<b>SBLW111</b>
.012 (2,612 ft.)	<b>SBLW112</b>



A.J. Wilcock® – World famous, never duplicated.

## Brass Separating Wire

**Brass Separating Wire** is high quality corrosion resistant 60/40 brass for posterior separation prior to band placement.

8 oz. reel

.018 (545 ft.)	<b>AW820-018</b>
.020 (450 ft.)	<b>AW820-020</b>

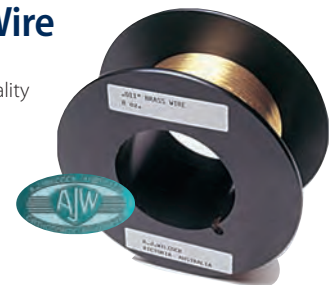

Please be advised that A.J. Wilcock® Australian Wire products may not be returned for credit or exchange.

## Australian Wire



### A.J. Wilcock® Australian Wire Products

*World famous, never duplicated.*

#### A.J. Wilcock® Australian Wire

A.J. Wilcock® Australian Wire is imported exclusively to North America through G&H® Orthodontics. These world-renowned stainless steel wire products offer superior hardness and tensile strength for a multitude of applications where exceptional resiliency is desired.

#### A.J. Wilcock® Stainless Steel Wire

A.J. Wilcock® Australian Wire has earned its reputation as the finest stainless steel of its kind. Strain aged processing ensures extraordinary resilience simply not found in any other orthodontic wire product.



Choose the grade that best meets your clinical needs

*Stiff Wire* →

← *Stiffest Wire*

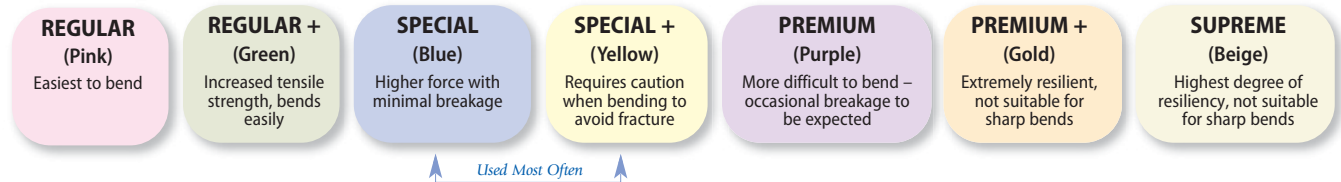

#### Spooled Australian Wire

•25 feet/spool

	Regular pink	Regular+ green	Special blue	Special+ yellow	Premium purple	Premium+ gold	Supreme beige
.009	N/A	N/A	N/A	N/A	N/A	N/A	AW227-060
.010	N/A	N/A	N/A	N/A	N/A	AW228-050	AW228-060
.011	N/A	N/A	N/A	N/A	N/A	AW228-150	AW228-160
.012	AW229-000	AW229-010	AW229-020	AW229-030	AW229-040	AW229-050	N/A
.014	AW230-100	AW230-110	AW230-120	AW230-130	AW230-140	AW230-150	N/A
.016	AW231-300	AW231-310	AW231-320	AW231-330	AW231-340	AW231-350	N/A
.018	AW232-400	AW232-410	AW232-420	AW232-430	AW232-440	AW232-450	N/A
.020	AW233-500	AW233-510	AW233-520	AW233-530	AW233-540	N/A	N/A
.022	AW234-600	N/A	N/A	AW234-630	N/A	N/A	N/A
.024	AW235-700	N/A	AW235-720	AW235-730	N/A	N/A	N/A

#### A.J. Wilcock® Pulse Straightened

Australian Wire improves martensitic response and smooth surface characteristics for reduced friction.



#### Pulse Straightened 10" Straight Lengths - Round

•30/tube

	Regular pink	Regular+ green	Special blue	Special+ yellow	Premium purple	Premium+ gold	Supreme beige
.009	N/A	N/A	N/A	N/A	N/A	N/A	AW227-061
.010	N/A	N/A	N/A	N/A	N/A	AW228-051	AW228-061
.011	N/A	N/A	N/A	N/A	N/A	AW228-151	AW228-161
.012	AW229-001	AW229-011	AW229-021	AW229-031	AW229-041	AW229-051	N/A
.014	AW230-101	AW230-111	AW230-121	AW230-131	AW230-141	AW230-151	N/A
.016	AW231-301	AW231-311	AW231-321	AW231-331	AW231-341	AW231-351	N/A
.018	AW232-401	AW232-411	AW232-421	AW232-431	AW232-441	N/A	N/A
.020	AW233-501	AW233-511	AW233-521	AW233-531	AW233-541	N/A	N/A
.022	AW234-601	N/A	N/A	AW234-631	N/A	N/A	N/A
.024	AW235-701	N/A	N/A	N/A	N/A	N/A	N/A

#### Rectangular

•10/tube

	Special blue	Special+ yellow
.016 x .016	AW601-616	AW611-616
.016 x .022	AW700-622	AW720-622
.017 x .022	AW700-722	AW720-722
.017 x .025	AW700-725	AW720-725
.018 x .022	AW700-822	AW720-822
.018 x .025	AW700-825	AW720-825
.019 x .025	AW700-925	N/A
.021 x .025	AW700-125	N/A
.0215 x .027	AW700-1527	N/A

Please be advised that A.J. Wilcock® Australian Wire products may not be returned for credit or exchange.

A.J. Wilcock® is a registered trademark of A.J. Wilcock PTY. LTD.

# Australian Wire



## A.J. Wilcock® Preformed Arches

World famous, never duplicated.

**Preformed Australian Archwires** are unsurpassed in resiliency and hardness with incredible levels of stored energy for rapid tooth alignment. Preformed **round arches** are made from Premium, Premium Plus and Special Plus Grade Australian wire. (Premium and Premium Plus are not recommended for intricate bends.) Preformed **rectangular arches** are manufactured from Special Plus Grade Australian wire. All Wilcock® rectangular archwires are sharp cornered with minimal radius to deliver highest possible torque values and maintain exacting specifications.

### Round Wire Arches

•25/pack

	Trueform™ I		Standard Form	
	Upper	Lower	Upper	Lower
<b>Special+</b>				
.014	AWTFU014SP+	AWTFL014SP+	AWSFU014SP+	AWSFL014SP+
.016	AWTFU016SP+	AWTFL016SP+	AWSFU016SP+	AWSFL016SP+
.018	AWTFU018SP+	AWTFL018SP+	AWSFU018SP+	AWSFL018SP+
.020	AWTFU020SP+	AWTFL020SP+	AWSFU020SP+	AWSFL020SP+
.022	AWTFU022SP+	AWTFL022SP+	AWSFU022SP+	AWSFL022SP+
<b>Premium</b>				
.020	AWTFU020	AWTFL020	AWSFU020	AWSFL020
<b>Premium+</b>				
.014	AWTFU014	AWTFL014	AWSFU014	AWSFL014
.016	AWTFU016	AWTFL016	AWSFU016	AWSFL016
.018	AWTFU018	AWTFL018	AWSFU018	AWSFL018

■ Premium and Premium+ are not recommended for intricate bends

**MIDLINE ID** Australian arches are ink-midline marked (Blue for Upper and White for Lower) or etched depending on wire color.



## A.J. Wilcock® Combination Arches

World famous, never duplicated.

These unique, highly resilient Special Plus Grade stainless steel wires are ideal for maintaining arch shape even when other auxiliaries and elastics are being used. Combination wires are rectangular in the anterior segment to maintain torque while the round posterior segments allow sliding mechanics with reduced friction.

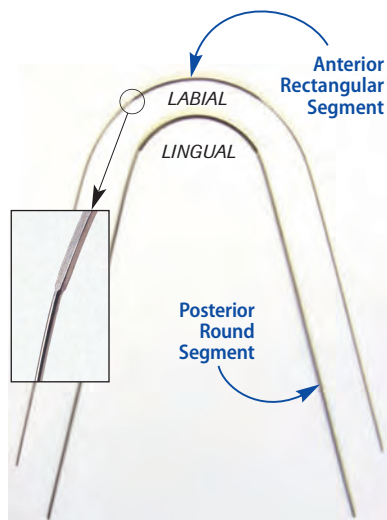

Each Combination Archwire Kit includes our anodized aluminum dispenser.

### Labial Available in Standard Form

#### Preformed Labial Combination Archwires

•2/pack

Anterior RECTANGULAR sizes  
26mm to 44mm, in 2mm increments

Anterior posterior	Special+ Grade
<u>.016"x.022"</u> .016"	AW771-622*
<u>.017"x.025"</u> .017"	AW771-725*
<u>.018"x.025"</u> .018"	AW771-825*
<u>.019"x.025"</u> .019"	AW771-925*

\* Insert preferred millimeter size of anterior

#### Labial Archwire Kit

(48 wires plus dispenser)  
Please state desired wire size when ordering  
AW771-\*\*\*KT  
(Sizes .016 to .019)

mm Size	Qty. in Kit
26	4
28	8
30	4
32	4
34	4
36	8
38	6
40	6
42	2
44	2

### Lingual Available in Universal Lingual

#### Preformed Lingual Combination Archwires

•2/pack

Anterior RECTANGULAR sizes  
26mm to 38mm, in 2mm increments

Anterior posterior	Special+ Grade
<u>.016"x.022"</u> .016"	AW671-622*
<u>.017"x.025"</u> .017"	AW671-725*
<u>.019"x.025"</u> .019"	AW671-925*
<u>.021"x.025"</u> .021"	AW672-125*
<u>.021"x.027"</u> .021"	AW672-127*

\* Insert preferred millimeter size of anterior

#### Labial Archwire Kit

(40 wires plus dispenser)  
Please state desired wire size when ordering  
AW671-\*\*\*KT  
(Sizes .016 to .019)  
AW672-\*\*\*KT  
(Sizes .021x.025 & .021x.027)

mm Size	Qty. in Kit
26	6
28	6
30	4
32	6
34	8
36	6
38	4

### Rectangular Wire Arches

•25/pack

	Trueform™ I		Standard Form	
	Upper	Lower	Upper	Lower
<b>Special+</b>				
.016x.016	AWTFU1616	AWTFL1616	AWSFU1616	AWSFL1616
.016x.022	AWTFU1622	AWTFL1622	AWSFU1622	AWSFL1622
.017x.025	AWTFU1725	AWTFL1725	AWSFU1725	AWSFL1725
.018x.018	AWTFU1818	AWTFL1818	AWSFU1818	AWSFL1818
.018x.022	AWTFU1822	AWTFL1822	AWSFU1822	AWSFL1822
.018x.025	AWTFU1825	AWTFL1825	AWSFU1825	AWSFL1825
.019x.025	AWTFU1925	AWTFL1925	AWSFU1925	AWSFL1925
.020x.020	AWTFU2020	AWTFL2020	AWSFU2020	AWSFL2020
.021x.025	AWTFU2125	AWTFL2125	AWSFU2125	AWSFL2125

Order Information:

**Standard Pack** – 25 archwires/pack

**Solo-Packs™**

– 10 individually sealed autoclavable archwires per carton. For Solo-Pack™ wires, add "S" to the end of part number. Please allow 2-3 days for Solo-Pack® packaging.



G&H®

## G4™ Nickel Titanium Closed Coil Springs

Precision Manufactured By G&H® Orthodontics



### G4™ Nickel Titanium Springs

The unique G4™ Nickel Titanium alloy developed by G&H® is precision formed into closed coil springs. G4™ Springs provide consistent force and remain active until the space is closed. Consistent force values and full recovery are both achieved routinely with G4™ NiTi Springs.

### G4™ Nickel Titanium Closed Coil Springs with Eyelets



Available with round eyelets on both ends (CC) or with one round and one TAD spring engagement eyelet (TAD). Packaged in convenient dispenser boxes, 10/box. See chart below for force values and part numbers.



### Distinct Identification





CC and TAD Spring boxes sizes and force values are clear and accurate at chairside. Color coded ID markings on boxes simplify selection of correct spring. Easy to dispense and reseal.

Wire size: .010" – I.D.: .030"

(Passive Spring Length) Length	Size	(Force Rating) Force	(10 springs/box) Order Numbers	Extension Measurement Landmarks (mm) / Subsequent Force Values (gms)					
				11mm	14mm	17mm	21mm	28mm	36mm
 9mm	9F	Feather Light (50g)	CCOF9FL	30	35	40	50*	X	X
	9X	Extra Light (100g)	CCOF9XL	60	70	80	100*	X	X
	9L	Light (150g)	CCOF9LT	95	115	130	150*	X	X
	9M	Medium (200g)	CCOF9MD	120	145	165	200*	X	X
(Pictured Actual Size)	9H	Heavy (250g)	CCOF9HV	135	175	210	250*	X	X
 12mm	12F	Feather Light (50g)	CCOF12FL	X	30	32	35	40	50*
	12X	Extra Light (100g)	CCOF12XL	X	60	65	70	80	100*
	12L	Light (150g)	CCOF12LT	X	95	100	115	130	150*
	12M	Medium (200g)	CCOF12MD	X	120	130	145	165	200*
	(Pictured Actual Size)	12H	Heavy (250g)	CCOF12HV	X	135	150	175	210

\*Indicates maximum overall extension for the respective spring length. Extending springs beyond the suggested maximum can cause permanent deformation and distort applied force values. Note: Force Values listed apply only to G4™ OrthoForce® Springs from G&H® Orthodontics. G&H® and OrthoForce® are registered trademarks of G&H® Wire Company, Inc. ©2016 G&H® Orthodontics

Wire size: .010" – I.D.: .030"

(Passive Length) Length	SIZE	(Force Rating) Force	(10 springs/box) Order Numbers	Extension Measurement Landmarks (mm) / Subsequent Force Values (gms)								
				13mm	15mm	17mm	19mm	22mm	27mm	31mm	36mm	41mm
 Extra Short (11mm)	A1	Light (150g)	CCOT45LT	95	125	150*	X	X	X	X	X	X
	A2	Medium (200g)	CCOT45MD	130	170	200*	X	X	X	X	X	X
	A3	Heavy (250g)	CCOT45HV	150	210	250*	X	X	X	X	X	X
 Short (13mm)	B1	Light (150g)	CCOT6LT	X	95	120	130	150*	X	X	X	X
	B2	Medium (200g)	CCOT6MD	X	125	150	170	200*	X	X	X	X
	B3	Heavy (250g)	CCOT6HV	X	150	180	200	250*	X	X	X	X
 Medium (15mm)	C1	Light (150g)	CCOT9LT	X	X	85	100	110	130	150*	X	X
	C2	Medium (200g)	CCOT9MD	X	X	115	140	150	180	200*	X	X
	C3	Heavy (250g)	CCOT9HV	X	X	145	165	175	220	250*	X	X
 Long (17mm)	D1	Light (150g)	CCOT12LT	X	X	X	85	95	110	120	130	150*
	D2	Medium (200g)	CCOT12MD	X	X	X	110	125	150	170	190	200*
	D3	Heavy (250g)	CCOT12HV	X	X	X	130	150	175	200	230	250*

(Springs shown actual size)

\*Indicates maximum overall extension for the respective spring length. Extending springs beyond the suggested maximum can cause permanent deformation and distort applied force values. Note: Force Values listed apply only to G4™ OrthoForce® Springs from G&H® Wire Company. G&H® and OrthoForce® are registered trademarks of G&H® Wire Company, Inc. ©2016 G&H® Wire Company, Inc.

Closed Coil Springs are also available in a G&H® exclusive comprehensive kit to provide forces as prescribed.



### (CC) Spring - 150 Gram Kit

Weighted kit featuring all necessary CC Springs for 150gm load applications. No matter what the extension, the kit contains the spring to apply 150gms. Kit includes 12 boxes of springs, (sizes may be altered if desired) 3 boxes of 9M, 9H, 2 boxes of 9L, 12L, 12M, 1 box of measuring gauges, inventory kit box and laminated force chart. Kit box keeps inventory neat and secure. Laminated heavy-duty design for extended use. Convenient and functional.

#KTCCOF150



### (TAD) Spring - 200 Gram Kit

Weighted kit featuring all necessary TAD Springs for 200gm load applications. No matter what the extension, the kit contains the spring to apply 200gms. Kit includes 12 boxes of springs, (sizes may be altered if desired) 3 boxes of A2, 2 of A3, B2, B3, 1 of C2, C3, D2, 1 box of measuring gauges, inventory kit box and laminated force chart. Kit box keeps inventory neat and secure. Laminated heavy-duty design for extended use. Convenient and functional.

#KTCCOT200

# G4™ NiTi Coil Springs

Precision Manufactured By G&H® Orthodontics

**G4™ NiTi Closed Coil Springs** deliver ideal forces for Class II intra-arch maxillary retraction as well as other space closure and maintenance applications. .030" I.D. coil diameter - 21" spool



	Force	21" Spool
Ultra Light	100 gm	CCNT21075
Light	150 gm	CCNT21150
Medium	200 gm	CCNT21200
Heavy	250 gm	CCNT21250

**G4™ NiTi Open Coil Springs** open and maintain space gently and efficiently in a convenient cut to length design. Three 7" lengths per package or convenient 21" spool.



Open Coil Springs			Force when compressed 25% (.250")	Force when compressed 50% (.500")	7" Straight	21" Spooled
Wire size	I.D.	Force	(Force in grams)	(Force in grams)		
.009"	.030	Ex-Light	95	225	OCNT09307	OCNT093021
.010"	.030	Light	120	260	OCNT10307	OCNT103021
.010"	.036	Med-Light	90	200	OCNT10367	OCNT103621
.012"	.030	Medium	220	480	OCNT12307	OCNT123021
.012"	.036	Medium-Hvy	180	380	OCNT12367	OCNT123621
.014"	.030	Heavy	360	700	OCNT14307	OCNT143021
.014"	.036	Ex-Heavy	270	560	OCNT14367	OCNT143621
.010"	.045	Facebow	55	120	OCNT10457	OCNT104521

Force determined by compressing a 1" open coil spring 25% (0.250") and 50% (0.500") and capturing the resulting force in grams.

**G4™ NiTi Open Coil Springs** sized in 15mm lengths designed for opening spaces up to 15mm. 10/box

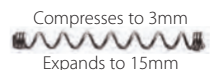

I.D.	Force		
.036	100gm	Light	OCNT15100
.036	150gm	Medium	OCNT15150
.036	200gm	Heavy	OCNT15200



## G4™ NiTi Molar Distalizing Open Coil Springs

deliver gentle 100 grams of force to achieve average 1mm to 1.5mm distalization per month without patient cooperation. Place over archwire and anchor with stop hook and elastics or Nance Appliance for maximum effectiveness. Intermittent closed coil sections allow for end stops when cut to length. .045" I.D. Three 7" lengths per pack, or 21" spool.

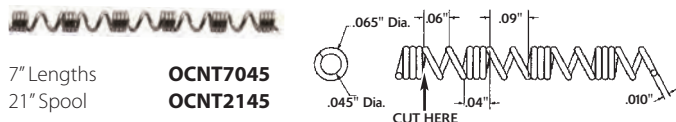

7" Lengths **OCNT7045**  
21" Spool **OCNT2145**

Note: Open and Closed Coil Springs with an .030" I.D. helix can be engaged over G&H® wires up to and including .019" x .025".

# Stainless Steel Coil Springs

## Stainless Steel Open & Closed Coil Springs

Stainless steel open and closed coil springs are available on 21" spools.



### Open Coil Springs

- .010x.028 **SSOC1028**
- .010x.030 **SSOC1030**
- .010x.036 **SSOC1036**



Open Coil

### Closed Coil Springs

- .010x.030 **SSCC1030**



Closed Coil



G&H offers a full line of quality orthodontic products - precision engineered and made in the U.S.A.

View and order our full line at:  
[GHOrthodontics.com](http://GHOrthodontics.com)



## Hooks, Stops & V-Tubes

### Slide-On Vertical Tube

New tube design which slides on a wire and has a second auxiliary tube positioned vertically. The .020x.020 vertical tube accepts auxiliaries like hooks. 20/Box

.017x.025 Red I.D. Mark **V-T1725**  
.019x.025 Black I.D. Mark **V-T1925**



Slide V-Tube on Archwire

### Shepherd Hooks

2 designs - One hook is 4mm high and the other is a double with heights of both 2mm and 6mm. 20/Box

4mm **SHPHK4**  
2, 6mm **SHPHK6**



### Stainless Steel "T" Hooks

Fit all V-Slot brackets, for elastics where needed.

50/pkg. **THK050**



### Crimpable Hooks

**Surgical & Arch Hooks** are cast for durability and reliable performance. 10/pkg.

#### Surgical Hooks with 1.25mm ball • 10/pack

	Fits up to .018 x .025	.022 x .028
Slide-On	SURHK620C	SURHK621C
Open-Wall (Universal)	SURHK	

#### Arch Hooks with .75mm ball • 10/pack

	Fits up to .018 x .025	.022 x .028
Slide-On	ARHK632C	ARHK633C
Open-Wall, Right	ARHK630CR	ARHK631CR
Open-Wall, Left	ARHK630CL	ARHK631CL

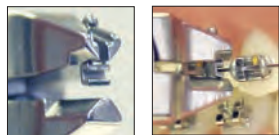
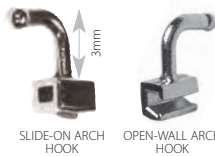

See page 100 for crimping pliers.

SEE ALL PLIERS  
BEGINNING ON  
PAGE 98

### Crimpable Micro-Stops

Use as an anchor to limit tooth movement. Thread wire through micro-stop, then crimp with any holding plier. 2mm long - 50/pkg

Small .012" to .018" **CSTOPSM**  
Large .020" to .020"x.020" **CSTOPLG**



### Crimpable Stops

Maintain wire positioning or limit tooth movement. Open wall, MIM crimpable stop fits round or rectangular wires .018" to .021"x.025".

2mm long - 10/box **CSTOPOW**



## Quad-Helix Expanders

### Quad-Helix Expanders

Combining the efficiency of the Quad-Helix appliance with the advantage of easy removal and insertion, allows greater flexibility and control during treatment. Available in various preformed sizes to be used with straight retention sheaths. (Sheaths available separately). Quad-Helix appliances are formed of .036 stainless.

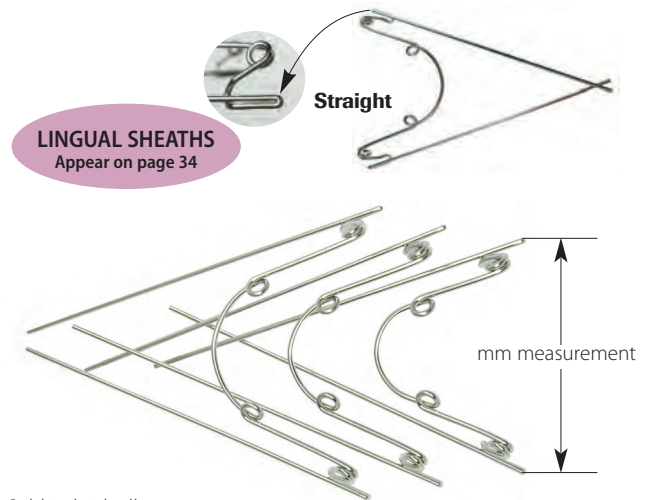

Sold individually

Quad-Helix Straight Size 1 **QDHXS1**  
Quad-Helix Straight Size 2 **QDHXS2**  
Quad-Helix Straight Size 3 **QDHXS3**

#### Size Selection:

Size 1 = 36,20mm  
Size 2 = 39,20mm  
Size 3 = 45,9.30mm

## Auxiliary Force Products

**Palatal Arch Bars** are formed in .036" stainless with double back bends for arch maintenance, molar rotation and distalization.

5/pkg. (Kits contain - 5 each of sizes 37, 39, 41, 47, 53, 55mm and 10 each of sizes 43 and 45mm, 50 pieces total).



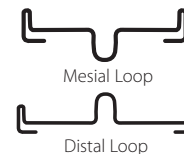

Size	Mesial Loop	Distal Loop	Size	Mesial Loop	Distal Loop
35mm	PAB35	PAB135	45mm	PAB45	PAB145
37mm	PAB37	PAB137	47mm	PAB47	PAB147
39mm	PAB39	PAB139	53mm	PAB53	PAB153
41mm	PAB41	PAB141	55mm	PAB55	PAB155
43mm	PAB43	PAB143	KIT	PABK050	PABK150



# Expansion Screws

**Expansion Screws** are precision made in Germany and available in a variety of styles for various applications. Stainless steel bodies and threads are extremely strong, and the mechanical design minimizes the potential for back-turning.

5/pkg. - Includes 5 small hand keys

			
<b>ESCR001</b> 7.5mm	<b>ESCR002</b> 5mm	<b>ESCR003</b> 5mm	<b>ESCR004</b> 5mm
APPLICATION Upper & Lower Midline	Lower Midline and Arch Lengthening	U-Shape Guide Pin for sectional expansion, arch lengthening and individual tooth movement.	
MM SIZE 14x10x3.15	12x7.5x3.5	13x6x3.2	13x7.5x3.5

Pre-Bent/Straight

## Rapid Palatal Expanders

Leone™ designed and manufactured in Italy. Renowned for their precision and durability, these palatal expanders are among the finest available. Expanders Include (1) Straight & Bent Key and Leash/pkg. (Also available separately)



### Expabent

Pre-Bent 8mm Body Length 12mm	<b>2000/8</b>
Pre-Bent 9mm Body Length 14mm	<b>2000/9</b>
Pre-Bent 11mm Body Length 15mm	<b>2000/11</b>
Pre-Bent 13mm Body Length 18mm	<b>2000/13</b>

### Palatal Suture Splitting and Expansion

Straight 8mm	<b>PALEXP008</b>
Straight 9mm	<b>PALEXP009</b>
Straight 11mm	<b>PALEXP011</b>
Straight 13mm	<b>PALEXP013</b>

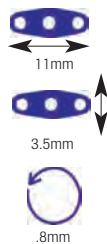

### Exspider (fan type)

9mm **A0625-09**



<b>Torko</b> 8mm 36mm arms	<b>A0623-08</b>
8mm 62mm arms	<b>X0022</b>
11mm 36mm arms	<b>A0623-11</b>
11mm 62mm arms	<b>X0023</b>



### Swivel Safety Activation Keys

Features secure-grip handle and offset insertion tip to prevent over-seating in screws. The swivel safety key is highly recommended for use with all expansion screws.

10/pkg. **EXPKY10**

- A) Straight Key - 100/pkg. **A0557-00**
- B) 45° Angle Key - 100/pkg. **A0557-01**
- C) Safety Leash - 100/pkg. **A0557-02**

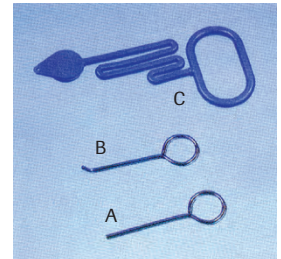

G&H offers a full line of quality orthodontic products -  
View and order our full line at:  
**GHOrthodontics.com**

# Elastomeric Products



Engineered to exacting standards to ensure consistent force delivery.

**Elastic Power Thread**

Medical grade elastomers precisely extruded for use in rotations and retraction applications. Hollow thread compresses to minimize slippage when knotted. Latex-free.

Ea.



Thread, Solid (50 ft. spool)	.025"	.030"
Grey	ETGY025	ETGY030
Clear	ETCL025	ETCL030

Thread, Slip-Not, Solid (25 ft. spool)	.025"	.030"
Grey	SNTGY025	SNTGY030
Clear	SNTCL025	SNTCL030

Thread, Hollow (50 ft. spool)	.025"	.030"
Grey	TBGY025	TBGY030
Clear	TBCL025	TBCL030

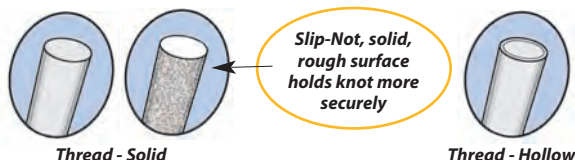

**Archwire Sleeve Protective Tubing**

Slides over wire to reduce irritation and maintains space where desired. Ideal for extraction site maintenance. Latex-free.

10 ft. per spool.

Archwire Sleeve	.018"	.027"	.046"
<b>Fits up to:</b>	<b>.018" Round</b>	<b>.021"x.027"</b>	<b>.046" Round</b>
Grey	ASPTG018	ASPTG027	ASPTG046
Clear	ASPTC018	ASPTC027	ASPTC046



**Clinical Tip:**  
To engage tubing on full size wires, apply a drop of alcohol to act as a lubricant.

**Safe-Seps Elastomeric Separators**

960/pkg. Latex-free

Heavy - Purple **500-003**  
Regular - Blue **500-004**

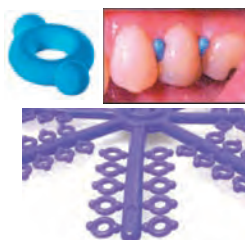

**Molded Elastomeric Separators**

.180" diameter, latex-free.

960/pkg. **500-001**



**Radiopaque Elastomeric Separators**

These separators are easily identified on x-ray and offer high resiliency for dependable separation quickly and efficiently. Medium blue color. 1,000/pkg. Latex-free

Small - 0.155" O.D., 0.042" thick **325-302**  
Large - 0.193" O.D., 0.049" thick **325-303**



SEE  
'SEPARATOR PLIER'  
ON PAGE 103

**Pre-loaded Canes**

Available in 2 sizes and in grey or clear. Pre-loaded canes have 50 ligatures each with 20 canes per pack (1,000 total pieces). Bulk packs of 5,000 loose ligatures per pouch. Latex-free

Ea.



**Pre-Loaded Canes and Bulk Ligatures**

	.110		.120	
	Cane	Bulk	Cane	Bulk
Grey	CGY10	BGY10	CGY20	BGY20
Clear	CCL10	BCL10	CCL20	BCL20

**Rotation Wedges**

Rotation wedges fit beneath the archwire to administer rotation forces where desired. Latex-free

100/pkg.

Clear **RWPCL100**  
Grey **RWPGY100**



**Non-Latex Elastics**

Non-Latex Elastics are ideal for avoiding patient sensitivity to latex. Manufactured of a unique polymer which eliminates the protein and other potential allergy reacting compounds associated with latex. Pouches contain 100 patient packs of 100 elastics.

Available in Natural Color only.

size	4.5 oz. medium	6.5 oz. heavy
3/16" (Blue label)	LFM36	LFH36
1/4" (Green label)	LFM14	LFH14



More latex-free elastomerics on pages 77.

## G&H® Intraoral/Extraoral Elastics



- Manufactured from the highest quality surgical grade latex
- Each patient pack is color-coded and individualized with its own Extreme Sport
- Force levels guaranteed consistent every time
- Each carton contains 50 patient packs - 100 elastics per pack



LIGHT Force Level				
1/8" (3.2mm)	3/16" (4.8mm)	1/4" (6.4mm)	5/16" (7.9mm)	3/8" (9.5mm)
MEDIUM Force Level				
1/8" (3.2mm)	3/16" (4.8mm)	1/4" (6.4mm)	5/16" (7.9mm)	3/8" (9.5mm)
HEAVY Force Level				
1/8" (3.2mm)	3/16" (4.8mm)	1/4" (6.4mm)	5/16" (7.9mm)	3/8" (9.5mm)

Elastic placement tool available - see page 135.

	1/8" (3.2mm)	3/16" (4.8mm)	1/4" (6.4mm)	5/16" (7.9mm)	3/8" (9.5mm)
<b>LIGHT</b> 3.5 oz.	M931-01	M931-02	M931-03	M931-04	M931-05
<b>MEDIUM</b> 4.5 oz.	M931-06	M931-07	M931-08	M931-09	M931-10
<b>HEAVY</b> 6.0 oz.	M931-11	M931-12	M931-13	M931-14	M931-15

## Enchanted™ Series Latex Elastics

All G&H® Enchanted™ Series Latex Elastics are packaged for quick and unique identification. G&H® manufactures amber and assorted color elastics from the finest surgical grade natural latex rubber to ensure reliable force delivery. Elastics are pre-packed in color coded Enchanted™ Patient Packs of 100 elastics and are dispensed from Enchanted™ Cartons—50 patient packs per box (5,000 total elastics).

Elastic Placement Tool included in each Enchanted™ pack!



### Patient Pack Dispenser Box

- I.D. label clearly identifies elastics
- Laminated cardboard construction & colorful artwork compliments operator
- Holds 50 patient packs
- Resists moisture
- Ensures fresh elastics - dry, clean storage
- Dispenser box stands on counter or fits in a convenient wall dispenser
- Patient-friendly easy to grab patient packs



Dimensions: 3" deep x 12 3/8" long x 10" high

**Dispenser for Carton Elastics** dispenses up to four cartons of elastics. Recommended for use with Enchanted™ Series Elastics. Anodized aluminum.

Ea. **ELDS400**

(See all of our dispensers on page 79)

1/8" (3.2mm) ORANGE BAG	CHARACTER	AMBER	COLOR
Light 2.5 oz. (70,88g)	Leprechaun	18LTAM	N/A
Medium 4.5 oz. (127,58g)	Dragon	18MDAM	18MDAC
Heavy 6.5 oz. (184,28g)	Wizard	18HVAM	18HVAC
3/16" (4.8mm) BLUE BAG	CHARACTER	AMBER	COLOR
Light 2.5 oz. (70,88g)	Frog Prince	36LTAM	N/A
Medium 4.5 oz. (127,58g)	Genie	36MDAM	36MDAC
Heavy 6.5 oz. (184,28g)	Unicorn	36HVAM	36HVAC
Extra Heavy 8.5 oz. (240,98g)	Gnome	36XHAM	N/A
1/4" (6.4mm) GREEN BAG	CHARACTER	AMBER	COLOR
Light 2.5 oz. (70,88g)	Giant	14LTAM	N/A
Medium 4.5 oz. (127,58g)	Sprite	14MDAM	14MDAC
Heavy 6.5 oz. (184,28g)	Pegasus	14HVAM	14HVAC
Extra Heavy 8.5 oz. (240,98g)	Minotaur	14XHAM	N/A
5/16" (7.9mm) RED BAG	CHARACTER	AMBER	COLOR
Light 2.5 oz. (70,88g)	Centaur	56LTAM	N/A
Medium 4.5 oz. (127,58g)	Trumpeter	56MDAM	56MDAC
Heavy 6.5 oz. (184,28g)	Knight	56HVAM	56HVAC
Extra Heavy 8.5 oz. (240,98g)	Jester	56XHAM	N/A
3/8" (9.5mm) PURPLE BAG	CHARACTER	AMBER	
Light 2.5 oz. (70,88g)	Pirate	38LTAM	
Medium 4.5 oz. (127,58g)	Barbarian	38MDAM	
Heavy 6.5 oz. (184,28g)	Roman Soldier	38HVAM	

**1/2" Extraoral Latex Elastics** Available in bulk pouches of 1,000 elastics, natural latex and amber color only. 1,000/pkg. 8 oz. **AX012B** 16 oz. **AXH12B**

**Private Logo Elastics** - Exclusively from G&H® **TOP SELLER!**

Precision Manufactured By G&H® Orthodontics

# Simple, free promotion for your practice!

No Additional Cost –

- Free Design!
- Free Setup!
- Free Advertising!



*“Private Logo Elastics are professional and present a positive image to patients and parents.”*

**Private Logo Series**

Your practice logo and contact information printed on patient packs! Each private logo series latex elastic carton contains 50 patient packs of 100 elastics. (5,000 Elastics)

*Please note: logos and/or artwork may need to be modified to facilitate print format and single-color reproduction.*

G&H® Private Logo Elastics I.D. sizing system is clear and simple:

**Color = Force Letter = Dimension**

Force Value	Dimension				
	A	B	C	D	E
Light = <b>RED</b>	General Packaging <b>A</b>	General Packaging <b>B</b>	General Packaging <b>C</b>	General Packaging <b>D</b>	General Packaging <b>E</b>
Medium = <b>GREEN</b>	Private Logo Available <b>A</b>	Private Logo Available <b>B</b>	Private Logo Available <b>C</b>	Private Logo Available <b>D</b>	General Packaging <b>E</b>
HEAVY = <b>Blue</b>	Private Logo Available <b>A</b>	Private Logo Available <b>B</b>	Private Logo Available <b>C</b>	Private Logo Available <b>D</b>	General Packaging <b>E</b>
X-HEAVY = <b>BROWN</b>	General Packaging <b>A</b>	General Packaging <b>B</b>	General Packaging <b>C</b>	General Packaging <b>D</b>	General Packaging <b>E</b>

*Due to production costs, we ask a minimum of 5 boxes be purchased per order, per elastic size and force value. This minimum applies to private logo designed packs only. All G&H® elastics have a 3 year shelf-life.*



- Clear and simple sizing: Color = Force, Letter = Dimension
- Available in the most popular sizes: 1/8", 3/16", 1/4", 5/16" – Medium and Heavy (Other sizes available without Private Logo packaging)
- 50 patient packs of 100 elastics per carton
- Natural Amber or Neon elastics available
- 3 year shelf-life on all elastics
- Made in the U.S.A. by G&H®

*\*Neon color elastics available in Private Logo sizes only*

## Manufacturing G&H® OrthoForce® Elastics

The quality of Orthodontic elastics varies greatly depending on the manufacturer. Elastics manufacturers face significant challenges in controlling quality as massive quantities are produced. G&H® Orthodontics is a precision manufacturer of elastics and understands the importance of consistent force values. G&H® has developed manufacturing processes which include in-process testing and recalibration to ensure the elastics we supply meet the stringent force value tolerances you require.



Fresh Latex – G&H® uses only Surgical Class I Grade natural latex with exacting I.D. and O.D. tolerances. Weekly shipments of tubing ensure fresh latex for maximum performance elastics.



G&H® precision cutter blades are recalibrated and sharpened multiple times daily. Elastics are precision cut to force value. Clean-cut edges ensure consistent expansion and force.



G&H® calibrated load cell testing every 15 minutes during production ensures exact and consistent force values. Elastics are tested at the industry standard expansion of 3 times passive diameter. Elastics are also 100% visually inspected and quality checked.

G&H®

## Elastomeric Ligature Ties

Latex-Free

### Versa-Ties™

**TOP SELLER!**

Our Versa-Tie™ elastomeric ligatures are designed to maximize clinical functionality and treatment efficiency.



Pictured actual size

**Optimum size ties** – .120 diameter

**Engage with a firm feel** – facilitate tooth movement & retention

**Score line** – allows easy conversion to half-sticks – avoids waste and cross-contamination

**Patient specific** – 22 ties per stick

**Etched thumb tabs** – for secure grip with gloves

**Colors coordinate with Dyna-Link™ Chain**

22 Ties per stick - 46 Sticks per package - 1,012 Ties total

Colors and Order Numbers listed on next page.

(Actual product colors may vary slightly)

Latex-Free

### Bambino-Ties™

**TOP SELLER!**

G&H® introduces a new design in elastomeric ligatures.



Pictured actual size



**Optimum size ties** – .120 diameter

**12 ties per stick** – eliminates waste and cross-contamination

**Elasticity and recovery** – allow retention to any size bracket

**Soft feel** – positive engagement

**Hold securely** – or wear on fingers for ease of engagement and multi-color application

**Colors coordinate with Dyna-Link™ Chain**

12 Ties per stick - 84 Sticks per package - 1,008 Ties total

Colors and Order Numbers listed on next page.

(Actual product colors may vary slightly)

## All tie styles available in 33 colors!



**Multi-Color Packs**

### Versa-Tie™ and Bambino-Tie™ Elastomeric Ligature Ties

Three different multi-color packages of 46 Versa-Tie™ or 84 Bambino™ sticks are now available from G&H®. See what colors your patients prefer!

NOTE: Clear, Gray, and Metallic Silver are not included in Multi-Color packs.



**Vibrant Pack** Includes: Pearl, Glow, Neon Green, Pearl Green, Glow Blue, Pearl Blue, Lavender, Maroon

Bambino™ - **BTVP84**  
Versa-Tie™ - **VTVP46**



**Assorted Pack** Includes: Black, Light Sky Blue, Pink, Green, Royal Blue, Ruby Red, Orange, and Metallic Purple

Bambino™ - **BTAS84**  
Versa-Tie™ - **VTAS46**



**Rainbow Pack** Includes: Metallic Gold, Metallic Red, Yellow, Metallic Blue, Deep Sky Blue, Fuchsia, Dark Transparent Green, Turquoise

Bambino™ - **BTRP84**  
Versa-Tie™ - **VTRP46**

Latex-Free

### Mini-Ties

The same clinical attributes as our standard Versa-Tie™ elastomeric ligature ties only in a convenient half-stick.

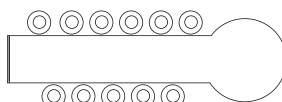

Illustration Actual Size



**Optimum size ties** – .120 diameter

**Engage with a firm feel** – facilitate tooth movement & retention

**11 Ties per stick** – avoids waste and cross-contamination

**Patient specific** – 11 ties per stick

**Etched thumb tab** – for secure grip with gloves

**Colors coordinate with Dyna-Link™ Chain**

11 Ties per stick - 92 Sticks per package - 1,012 Ties total

Colors and Order Numbers listed on next page.

(Actual product colors may vary slightly)

Latex-Free

### Select-Ties

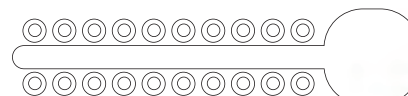

Illustration Actual Size



**Optimum size ties** – .120 diameter

**20 ties per stick** – eliminates waste and cross-contamination

**Elasticity and recovery** – allow retention to any size bracket

**Soft feel** – positive engagement

**Colors coordinate with Dyna-Link™ Chain**

20 Ties per stick - 50 Sticks per package - 1,000 Ties total







Colors and Order Numbers listed on next page.

(Actual product colors may vary slightly)

## Color Chart For Elastomeric Ties & Chain

CLEAR	GLOW	PEARL	MET. RED	RUBY RED	ORANGE
WHITE	GLOW BLUE	PEARL GREEN	MET. GOLD	MAROON	FLUORESCENT ORANGE
BLACK	TOOTH	PEARL BLUE	MET. PURPLE	LAVENDER	FUCHSIA
GRAY	NEON GREEN	GREEN	TRANS. GREEN	TURQUOISE	PINK
SMOKE	DEEP SKY BLUE	NAVY BLUE	MET. BLUE	ROYAL BLUE	FLUORESCENT PINK
MET. SILVER	LT. SKY BLUE	YELLOW			

## Order Numbers For Elastomeric Ties & Chain

	Versa-Tie™	Bambino-Tie™	Mini-Tie	Select-Tie	Dyna-Link™ Chain		
							
	VTPL46	BTPL84	OCMPL	OCSLPL	CDLPL	SDLPL	LDLPL
Pearl	VTPL46	BTPL84	OCMPL	OCSLPL	CDLPL	SDLPL	LDLPL
Glow	VTGW46	BTGW84	OCMGL	OCSLGL	CDLGL	SDLGL	LDLGL
Neon Green	VTNG46	BTNG84	OCMNG	OCSLNG	CDLNG	SDLNG	LDLNG
Pearl Green	VTPG46	BTPG84	OCMPG	OCSLPG	CDLPG	SDLPG	LDLPG
Glow Blue	VTGB46	BTGB84	OCMGB	OCSLGB	CDLGB	SDLGB	LDLGB
Pearl Blue	VTPB46	BTPB84	OCMPB	OCSLPB	CDLPB	SDLPB	LDLPB
Lavender	VTLV46	BTLV84	OCMLV	OCSLLV	CDLLV	SDLV	LDLV
Maroon	VTMA46	BTMA84	OCMMA	OCSLMA	CDLMA	SDLMA	LDLMA
Clear	VTCL46	BTCL84	OCMCL	OCSLCL	CDLCL1	SDLCL1	LDLCL1
Gray	VTGY46	BTGY84	OCMGY	OCSLGY	CDLGY	SDLGY	LDLGY
Metallic Silver	VTSV46	BTSV84	OCMMS	OCSLMS	CDLSV	SDLV	LDLSV
Metallic Gold	VTGD46	BTGD84	OCMGD	OCSLGD	CDLGD	SDLGD	LDLGD
Metallic Purple	VTPP46	BTPP84	OCMPP	OCSLPP	CDLPP	SDLPP	LDLPP
Metallic Red	VTMR46	BTMR84	OCMMR	OCSLMR	CDLMR	SDLMR	LDLMR
Metallic Blue	VTMB46	BTMB84	OCMMB	OCSLMB	CDLMB	SDLMB	LDLMB
Royal Blue	VTRB46	BTRB84	OCMRB	OCSLRB	CDLRB	SDLRB	LDLRB
Lt. Sky Blue	VTLS46	BTLS84	OCMLS	OCSLLS	CDLLS	SDLLS	LDLLS
Deep Sky Blue	VTDS46	BTDS84	OCMDS	OCSLDS	CDLDS	SDLDS	LDLDS
Navy Blue	VTNB46	BTNB84	OCMNB	OCSLNB	CDLNB	SDLNB	LDLNB
Green	VTGR46	BTGR84	OCMGR	OCSLGR	CDLGR	SDLGR	LDLGR
Trans. Green	VTTG46	BTTG84	OCMTG	OCSLTG	CDLTG	SDLTG	LDLTG
Ruby Red	VTRR46	BTRR84	OCMRR	OCSLRR	CDLRR	SDLRR	LDLRR
Turquoise	VTTQ46	BTTQ84	OCMTQ	OCSLTQ	CDLTQ	SDLTQ	LDLTQ
White	VTWT46	BTWT84	OCMWT	OCSLWT	CDLWT	SDLWT	LDLWT
Fuchsia	VTFU46	BTFU84	OCMFU	OCSLFU	CDLFU	SDLFU	LDLFU
Black	VTBK46	BTBK84	OCMBK	OCSLBK	CDLBK	SDLBK	LDLBK
Orange	VTOR46	BTOR84	OCMOR	OCSLOR	CDLOR	SDLOR	LDLOR
Fluor. Orange	VTFO46	BTFO84	OCMFO	OCSLFO	CDLFO	SDLFO	LDLFO
Yellow	VTYW46	BTYW84	OCMYW	OCSLYW	CDLYW	SDLYW	LDLYW
Pink	VTPK46	BTPK84	OCMPK	OCSLPK	CDLPK	SDLPK	LDLPK
Fluor. Pink	VTFP46	BTFP84	OCMFP	OCSLFP	CDLFP	SDLFP	LDLFP
Tooth	VTTC46	BTTC84	OCMTC	OCSLTC	CDLTC	SDLTC	LDLTC
Smoke	VTSM46	BTSM84	OCMSM	OCSLSM	CDLSM	SDLSM	LDLSM



### Elastomeric Ligature Display Booklet

Neatly displays elastomeric ligature ties for color selection by patient or clinician. Holds 34 tie sticks. Available with or without ligatures. Comes with color identification labels. Measures 7"x7" when folded.

Ea.

- Un-Filled Display **DBK**
- Filled Versa-Tie™ Display **DBKVT**
- Filled Bambino-Tie™ Display **DBKBT**
- Filled Select-Tie Display **DBKOS**
- Filled Mini-Tie Display **DBKOM**



## TOP SELLER!

Latex-Free

### Dyna-Link™ Elastomeric Chain

Dyna-Link chain offers superior memory and durability characteristics with excellent color stability and stain resistance. G&H® precision engineers each style of Dyna-Link™ to exacting standards to ensure consistent force delivery with minimal decay rates.

.026" thick



Available In  
All 33 Colors!

**Dyna-Link™ Elastomeric Chain** is precision manufactured and scientifically tested by G&H® to ensure:

- Continuous, gentle force for predictable tooth movement
- High elasticity with superior memory and rebound
- Excellent color stability
- 3 spacing variations between links
- .026" thickness
- 15 ft. spool
- Colors coordinate with Bambino-Ties™, Versa-Ties™, Select-Ties & Mini-Ties.

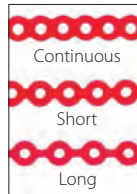

Actual size

Colors and Order Numbers listed on previous page.  
(Actual product colors may vary slightly)

Latex-Free

### Slim-Chain™ Elastomeric Chain

G&H's new **Slim-Chain™** is a thin version for increased comfort and also to accommodate lingual treatment mechanics. Only .018" in thickness, this chain has a low profile along with the elasticity and recovery needed for effective movement.

Only .018" thick



- Low profile - great for lingual treatment and comfort
- Thinner chain - easier to ligate under tie wings / self-ligating brackets
- Superb resiliency & memory
- 15 ft. spool



Available In  
Clear, Pearl  
& Silver

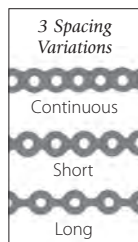

Actual size

3 Colors Available –

CLEAR	PEARL	MET. SILVER
<b>Clear Slim-Chain™</b> Continuous - CDLCLT Short - SDLCLT Long - LDLCLT	<b>Pearl Slim-Chain™</b> Continuous - CDLPLT Short - SDLPLT Long - LDLPLT	<b>Silver Slim-Chain™</b> Continuous - CDLSVT Short - SDLSVT Long - LDLSVT

### Elastomeric Chain Dispenser

Our chain dispenser features a lid that encloses the spools to prevent inadvertent contamination. Stores twelve spools. Measures 3" wide x 8 1/8" long x 3 1/8" high. Made of anodized aluminum with a brushed finish.

Ea.

**CHDSA700**

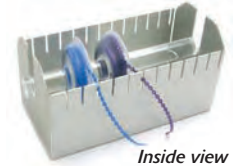

Inside view

Smart Rack™

### Elastomeric Single Chain Storage

Holds up to 14 spools of 15 ft. chain.  
Measures 7.25" L x 3.25" W x 3.5" H.

Ea.

**RACKSC**



Smart Rack™

### Elastomeric Dual Chain Storage

Holds up to 28 spools of 15 ft. chain.  
14 per rod. Measures 7.25" L x 6" W x 3.5" H.

Ea.

**RACKDC**



# SAVE

## Discover Your Orthodontic Buying Power!

Your membership in the unique G&H® OrthoClub® results in big savings. Enjoy buying-group savings on more than 6,000 brand-name clinical supplies plus get special discounts on products manufactured by G&H.

G&H's OrthoClub® –  
Nothing else like it in Orthodontics!



# PowerLinx™ Chain - Latex-Free



## A biomaterial breakthrough in elastic chain

G&H® Orthodontics' "PowerLinx™" chain is produced from a unique and proprietary blend of thermoset polymers. Thermoset polymers molecular stability produces increased elasticity and resiliency that retain forces for extended periods of time.

Documented scientific research proves PowerLinx™ can endure higher stresses longer with minimal force degradation (see graph below). The recovery force of PowerLinx™ remains elevated and active over a longer timeframe than traditional chain. The result is that PowerLinx™ produces more effective and tenacious forces for facilitating tooth movement.

Each spool contains 2 meters (6.56 ft.) .020" thickness.

- Short Clear
- Short Gray
- Long Clear
- Long Gray

- SPLCL**
- SPLGY**
- LPLCL**
- LPLGY**



### Deformation Comparison

Plastic chain (photos actual size)



PowerLinx™ chain (photos actual size)



PowerLinx™ Chain retains up to 85% of its original pull strength even after 6 weeks of engagement.

G&H Dyna-Link™ chain is consistent in strength and force values and available in 33 colors. (see page 79)



# Clinical Supplies



G&H offers a complete line of clinical, bonding and lab supplies.

Reliance®

# Light Cure Bonding Adhesives

G&H® offers the complete line of **Reliance® bonding products**. Reliance® is well known in the orthodontic community as the most reliable high quality adhesives available. Sold in convenient kits or as individual components.



## Light Bond® Light Cure Bonding Adhesive

**Fluoride Releasing:** Light Bond™ Paste and Sealant are formulated with a patented fluoride releasing monomer. University studies have shown that fluoride is continuously released throughout the mouth without reducing bond strength.

**Smooth, Tacky Paste Viscosity:** The viscosity of Light Bond™ Paste is very tacky which totally prevents bracket floatation. If a thinner paste viscosity is desired for bonding lingual retainers and palatal expanders, Light Bond™ Medium or Thin Paste is available. Specify when ordering.

**Total Paste Polymerization Under All Bracket Bases:** Light Bond™ is comprised of a unique catalyst and filler that reflects the light to ensure complete polymerization under any appliance - metal, ceramic, sapphire or plastic. Once the material has been properly cured, an active archwire can be placed immediately.

**Choice of Protective Sealants:** Conventional chemical cure sealants do not totally polymerize due to oxygen inhibition. Light Bond™ Sealant totally polymerizes when exposed to a visible light source for 10 seconds. As a result, the etched enamel surface is sealed with a clear fluoride releasing enamel protective sealant. Also available is Light Bond™ Filled Sealant, which contains 40% micro particle size filler making it abrasion resistant and fluoride releasing.

### COMPONENTS—

#### Regular Paste

5g in (11) Syringe Tips  
(1) 5g Push Syringe

**LBPTF**  
**LBPPF**

#### Medium Paste

5g in (11) Syringe Tips  
(1) 5g Push Syringe

**LBMPTF**  
**LBMPPF**

#### Thin Paste

5g in (11) Syringe Tips  
(1) 5g Push Syringe

**LBTPTF**  
**LBTPPF**

Light Bond™ Sealant 3 cc  
Light Bond™ Filled Sealant 3 cc  
Light Bond™ Sealant 7 cc  
Light Bond™ Filled Sealant 7 cc

**LBS3F**  
**LBFSF**  
**LBS7F**  
**LBFS7F**

*Note: Paste is available in 3 viscosities: Regular / Medium / Thin. Regular is sent if not otherwise specified.*

### KITS—

#### Light Bond™ - Reg. Paste

20g paste in (44) Tips  
Paste in (4) 5g Push Syringes

**LBETF**  
**LBEPF**

#### Light Bond™ - Reg. Paste (Blue Shade)

20g paste in (44) Tips

*Note: LBEBTF is not available for Canadian shipment.*

**LBEBTF**

Paste in (4) 5g Push Syringes

**LBEBPF**

Suitable for use with MiniMold system, page 91



## Pad Lock™

Light cure bonding adhesive - creates a combination mechanical and chemical bond.

### Components—

(1) 4.5g syringe  
(1) 4.5g syringe w/fluoride  
4.5g in (10) tips  
4.5g in (10) tips w/fluoride

**PLP**  
**PLPF**  
**PLT**  
**PLTF**

### KITS—

4.5g in (10) syringe tips  
4.5g in (10) syringe tips w/fluoride  
(4) push syringes, 4.5g in each  
(4) push syringes, 4.5g in each w/fluoride

**PLTK**  
**PLTKF**  
**PLPK**  
**PLPKF**

## L.C.R.™ Light Cure Retainer

Highly filled, single paste light cured retainer adhesive.

### Components—

(1) 5g push syringe  
5g paste in (11) tips

**LCR**  
**LCRT5**

### KITS—

20g in (4) push syringes  
20g paste in (44) syringe tips

**LCREP**  
**LCRET**



## Flow Tain®

Flow Tain® is a new flowable light cured composite with low viscosity which makes it ideal for bonded lingual retainers and splints.

### Flow Tain® (medium viscosity)

1.5g Syringe with (10) needle tip cannulas (19 gauge) **FT**

Replacement needle tip cannulas (10) **FTTIPS**

*Note: FTTIPS is not available for Canadian shipment.*

### Flow Tain® LV (light viscosity)

1.5g Syringe with (10) needle tip cannulas (22 gauge) **FTLV**

Replacement needle tip cannulas (10) **FTLVTIPS**

*Note: FTLVTIPS is not available for Canadian shipment.*



## Bonding Aligner Adhesive

Clear light cure adhesive to adhere metal, ceramic or plastic attachments to any aligner plastic.

Ea. **BA**



## Quick Cure™

Light activated orthodontic adhesive.

### Components—

(1) 5g push syringe  
5g in (11) tips

**QCPP**  
**QCPT**

Suitable for use with MiniMold system, page 91

### KITS—

20g paste in (4) push syringes,  
with 6cc Assure® Sealant

**QCPAS**

20g paste in (4) push syringes,  
with 6cc Light Bond® Sealant

**QCPLB**

20g paste in (44) tips,  
with 6cc Assure® Sealant

**QCTAS**

20g paste in (44) tips,  
with 6cc Light Bond® Sealant

**QCTLB**

## Therma-Cure™

Heat curable lab adhesive for indirect bonding.



(1) 5g syringe **TC**

## Assure® Light Cure Band Cement

Fluoride releasing light cure orthodontic adhesive. Assure® is the ideal viscosity to prevent bracket floatation while maximizing bond strength by chemically bonding to metal bracket bases. This single paste light cure adhesive releases a high level of fluoride and will bond to slightly contaminated sealant.

### Assure® Paste

(1) 5g screw syringe

**APP**

### KIT—

#### Assure® Kit

Paste in (4) 5g screw syringes

**AKP**

*Note: AKP is not available for Canadian shipment.*

## Button Hook Aligner Attachment

The Button Hook Attachment Form can be used for Class II Elastics when using a clear aligner system.

Ea. **ABUT**



Reliance®

## Mixed Paste Self-Cure Bonding Adhesives



### Phase II®

Fluoride releasing sealant/paste system.

**Components—**

- Paste A - 18g jar **PJAF**
- Paste B - 18g jar **PJB**
- Paste A - (3) 6g screw syringes **PSAF**
- Paste B - (3) 6g screw syringes **PSB**
- Sealant Resin A - 7g **S7AF**
- Sealant Resin B - 7g **S7B**
- Economy Sealant Resin A - 20g **S20AF**
- Economy Sealant Resin B - 20g **S20B**

**KITS—**

- Paste in (6) 6g screws syringes **PSF**
- Paste in (2) 18g jars **PJF**

Note: PSF and PJF are not available for Canadian shipment.

### Phase II® Dual Cure

Fluoride releasing sealant/paste system.

**Components—**

- Paste A - 18g jar **DCJAF**
- Paste B - 18g jar **PJB**
- Paste A - (3) 6g screw syringes **DCSAF**
- Paste B - (3) 6g screw syringes **PSB**

**KITS—**

- Paste in (2) 18g jars **DCJF**
- Paste in (6) 6g screw syringes **DCSF**

Note: DCJF and DCSF are not available for Canadian shipment.

## Sealants

### Pro Seal™

Light cure fluorescing filled sealant with fluoride.

Pro Seal™ is a state-of-the-art fluoride protective sealant and its armor like strength protects the enamel surface.

6ml bottle **PRO**



### L.E.D. Pro Seal™

Filled sealant with fluoride, cures with any LED curing light.

6ml bottle **LEDPRO**



### Assure® Sealant

Universal bonding agent.

Assure® Sealant will increase adhesion to normal, atypical, dry or slightly contaminated enamel. Bonds to metal restorations without additional primers. No light curing required and it can be used with any light or chemical cure system.

6cc bottle **AS**



### Assure® Plus

All surface bonding resin.

Assure® Plus will increase adhesion to normal, atypical, dry or slightly contaminated enamel and zirconia and acrylic temps without additional primers. Bonds to metal and porcelain restorations without hydrofluoric acid.

6cc bottle **PLUS**



Reliance®

## No-Mix Self-Cure Bonding Adhesives



### Rely-A-Bond®

No-mix adhesive in both fluoride and non-fluoride releasing formulas.

**Components—**

- Paste (1) 14g jar **RPJ**
- Paste (4) 3.5g push syringes **RPP**
- Paste - thin (4) 3.5g push syringes **RPPT**
- Paste - 14g in (33) syringe tips **RPT**
- Primer - 16g **RPRF**

**KITS—**

- Non-Fluoride, 14g paste in (33) tips **RT**
- Non-Fluoride, 14g paste in jar **RJ**
- Non-Fluoride, 14g paste in (4) push syringes **RP**
- Fluoride releasing, 14g paste in (33) tips **RTF**
- Fluoride releasing, 14g paste in jar **RJF**
- Fluoride releasing, 14g paste in (4) push syringes **RPF**

### Maximum Cure®

Fluoride releasing, chemical cure sealant system.

**Components—**

- Sealant A - 7g **MC7AF**
- Sealant B - 7g **MC7B**
- Filled sealant A - 7g **MCF7AF**
- Filled sealant B - 7g **MCF7B**
- Economy sealant A - 20g **MC20AF**
- Economy sealant B - 20g **MC20B**

### Custom I.Q.™

Fluoride releasing, fast set indirect bonding sealant.

**Components—**

- Sealant A - 7g **CIQA**
- Sealant B - 7g **CIQB**

# Reliance® Cements



## Ultra Band-Lok™ Light Cure Band Cement

**Fluoride Releasing:** Single paste cement which bonds chemically to metal.

**No Wasteful Mixing:** Single paste system.

**Light Activated:** No working time constraints.

**All Purpose Cement:** Ultra Band-Lok™ can also be used to bond brackets, lingual retainers and large acrylic appliances. When bonding these appliances, you must first etch the enamel surface.

**Available In:** Translucent tooth shade to blend in or blue shade to aid in clean up prior to curing.

### COMPONENTS—

Ultra Band-Lok™ Paste **UBLPP**  
(1) 5g Push Syringe

Ultra Band-Lok™ Paste Blue **UBLBPP**  
(1) 5g Push Syringe

Ultra Band-Lok™ Luer Loc Syringe **LLUBLP**  
(1) 5g syringe w/10 tips

Ultra Band-Lok™ Luer Loc Syringe (Blue) **LLUBLBP**  
(1) 5g syringe w/10 tips

Luer Loc Tips for UBL Syringe **LLTIPS**  
60 Tips/pkg.

*Note: LLTIPS is not available for Canadian shipment.*

Ultra Band-Lok™ Luer Loc Syringe Kit **LLUBL**  
(6) 5g syringes w/60 15 gauge tips

Ultra Band-Lok™ Luer Loc Syringe Kit (Blue) **LLUBLB**  
(6) 5g syringes w/60 15 gauge tips

### KITS—

Ultra Band-Lok™ Economy Kit **UBL**  
Paste in (6) 5g Push Syringes

Ultra Band-Lok™ Economy Kit Blue **UBLB**  
Paste in (6) 5g Push Syringes

*Note: UBL and UBLB are not available for Canadian shipment.*



## Band-Lok™

Self-cure, fluoride releasing, two paste glass ionomer band cement.

**Band-Lok™** is a dual cure cement. It can be used with or without a curing light. When band is placed and flash is cleaned, a 20-second light activation allows full protection from moisture. Without light activation, a complete set is achieved in 10 minutes.

### Components—

Paste A - (1) 6g screw syringe **BLSA**  
Paste A - (1) 6g screw syringe (blue) **BLSAB**  
Paste B - (1) 6g screw syringe **BLSB**

### KITS—

Economy kit - paste in (8) 6g screw syringes (4) of part A and (4) of part B **BL**

Economy kit (blue) - paste in (8) 6g screw syringes (4) of part A (blue) and (4) of part B **BLB**

*Note: BL and BLB are not available for Canadian shipment.*



## Crown Lok™

Self-cure, fluoride releasing, two paste band cement.

**Crown Lok™** is a self-curing two minute working time fluoride releasing cement. This versatile cement will bond chemically to all metal crowns, bands, and appliances, reducing the chance of failure and facilitating cleanup at the conclusion of treatment. Available in tooth color shade or high visibility blue.

### Components—

Paste A - (1) 6g screw syringe **CLSA**  
Paste A - (1) 6g screw syringe (blue) **CLSAB**  
Paste B - (1) 6g screw syringe **CLSB**

### KITS—

A & B pastes kit - (4) 6g screw syringes **CL**  
A blue and B pastes kit - (4) 6g screw syringes **CLB**

*Note: CL and CLB are not available for Canadian shipment.*



## Precedent®

Fluoride releasing, glass ionomer.

### Components—

Powder 15g **PRP15**  
Powder 100g **PRP100**  
Liquid 15cc **PRL15**  
Liquid 90cc **PRL90**

### KITS—

Starter kit - 15g powder, 15cc liquid **PRS**  
Economy kit - 100g powder, 90cc liquid **PRE**

*Note: Precedent® is not available for Canadian shipment.*

## Reliance® Veneer Paste



## O.V.S.™ Orthodontic Veneer System

O.V.S. will provide a complete in-office system that creates an esthetic and properly sized temporary veneer surface to bond your attachment. This saves you and your patients both time and money by eliminating the need for a full temporary crown.

Kit **OVS**

*Note: OVS is not available for Canadian shipment.*

### Individual Components

Shade A-1, Syringe **OVPA1**  
Shade A-2, Syringe **OVPA2**  
Shade B-1, Syringe **OVPB1**

*Note: OVPA1, OVPA2, and OVPB1 are not available for Canadian shipment.*

Stick-N-Place Instrument **SNP20**



## Faci Forms

(4) medium & (4) large - 8/pkg.

Left #12 **FFL**  
Right #22 **FFR**

## Reliance® Retention Systems

### Retainium™



Single strand Nickel-Free titanium flat metal ribbon is ideal for semi-permanent splinting and maintaining difficult extraction sites.

- Eliminates potential patient allergy issues
- Reduced wear rate
- Increased interproximal strength
- 60" total - 10 (6inch) strands
- Dimensions: .011" x .027"

(10) 6 inch strands/pkg.

RET

### Ortho FlexTech™



The next generation in lingual retention.

- Stabilizes orthodontic corrections
- Prevents rotational relapses
- Easy application - naturally forms to lingual arch curvature
- Less doctor time / less chair time
- Low failure rate due to "flex linkage"
- No laboratory costs or delays
- Improved patient comfort - lays flat against the teeth
- Lasting esthetics - 14k gold or stainless steel
- 30" length - makes 25 cuspid to cuspid retainers

14 karat gold - 30" length  
Stainless Steel - 30" length

OFT2  
SSOFT

### Hilgers Bond-A-Braid™

The dead soft wire easily adapts and is excellent for semi-permanent orthodontic splinting of the upper and lower incisors, diastema maintenance and other tooth splinting.

- Lingual retainer
- .027" x .011" ribbon arch wire
- 8-strand braided wire
- Dead soft - adapts easily

6" length - 10/tube

BAB2

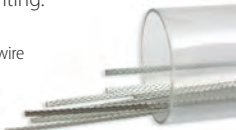

### Full Chain & Composite Kit

Used for the extrusion of teeth.

Kit contains: 2ml of Assure Bonding Resin, Flowtaint w/ 2 dispensing tips, 3 medium ovals 2 large pads

Kit  
Handle only  
Medium Pad (3)  
Large Pad (2)

CCK  
MMH  
CCO  
CCP

## Reliance® Boosters

### Enhance L.C.™

Single component Enhance™ light cure.

Enhance™ L.C. - 6cc

LCE6

Enhance™ Adhesion Booster - for hypo-calcified or fluorosed enamel

Part A - 3cc

Part B - 3cc

Part A - 6cc

Part B - 6cc

EBAA  
EBAB  
EBAA6  
EBAB6



## Reliance® Prep & Finish

### 1st & Final™

Pre-packaged orthodontic pumice.

200/pkg.

FF



### Renew Finishing System™

Adhesive removal & finishing system.

Bur - 1185 (1)

Bur - 118L (1)

Bur - 218 (1)

Point - 383 (12) straight handpiece

Point - 383 (12) latch

Point - 383 (12) friction grip

Diamond Bur - 129 (1)

RSB  
RSBL  
RSB2  
RSPHP  
RSPL  
RSPFG  
DB

Restore Diamond Polishing Paste

2 oz. (56.7g)

RESPP

## Reliance® Clinical Training Aids

Chairside Bonding Technique Cards TECH

Clinical Training Videos -  
Bonding DVD

DOBRG2



## Reliance® Etchants & Conditioners

Plastic Conditioner 10cc

PL

Porcelain Conditioner 8cc

PO

Metal Primer 10cc

ME



### Porc-Etch™

Porcelain etching agent (9g)  
with barrier gel (3cc)

POE  
GEL

Barrier Gel (3cc)

Note: GEL is not available for Canadian shipment.



## Reliance® Etchants & Conditioners

### Etchant

Etchant Liquid

Bottle - 9g

Economy size - 18g

EL9  
EL24

Etchant Gel

Bottle - 9g

Economy size - 18g

Economy syringe pack

(5) 6.5g syringe w/100 tips

EG9  
EG18

EGES



### S.E.P.™ Self-Etching Primer

S.E.P. Kit

Contains: (3) mixing wells, (1) dispenser,  
(2) refill cartridges - enough for 100 arches,  
(100) Microbrushes®

SEP

S.E.P. Primer Refill

(1) refill cartridge -

enough for 50 arches

SEPR

S.E.P. Primer Dispenser (1)

SEPD

Note: SEPD is not available for Canadian shipment.



### Reliance® Self Mixing Tips

Special mixing cannula tip which  
eliminates operator mixing and  
provides a consistent, automatic mix.

15/pkg.

SMT

Note: SMT is not available for Canadian shipment.

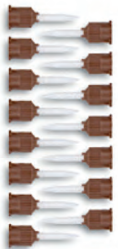

## Reliance® Pontic Paint

### Perfect-A-Smile™

Perfect-A-Smile is a single light cure paint that  
comes in 3 shades and can be painted on any  
aligner material to mask a space or missing tooth.



Shade B-1, Light Shade

8g jar

PPB1

Shade A-2, Medium Shade

8g jar

PPA2

Shade A-3, Dark Shade

8g jar

PPA3

Note: PPA3 is not available for Canadian shipment.

Complete Kit

PAS

Kit Contains:

(1) 8g jar light shade

(1) 8g jar medium shade

(1) 8g jar dark shade

1 pack of 100 super fine microbrushes

(3) spatulas

# Bonding Accessories

## Ketac-Cem®

Permanent glass ionomer luting cement.

### Intro Pack -

12mL liquid, 33gm powder, mixing pad

Kit **37201**

### Triple Pack -

(3) 12mL liquid, (3) 33gm powder

Kit **37231**

### Giant Pack -

(10) 12mL liquid, (10) 33gm powder, 2 mixing pads, 2 liquid droppers

Kit **37251**

### Powder -

33gm bottle

Btl. **37211**

### Liquid -

12mL bottle

Btl. **37221**



## GC

## Fuji Ortho

### LC Intro Kit

One 15g powder, one 6.8ml bottle of liquid, mixing pad and scoop.

**439401**

### LC Standard Kit

40g powder, 2 x 8g liquid, measuring scoop & mixing pad.

**439403**

*Note: LC Standard Kit is not available for Canadian shipment.*

### LC Components

40g Powder  
6.8ml Liquid  
8ml

**000029**  
**000030**  
**000206**

### LC Capsules

50 capsules  
0.30g Powder & 0.10g Liquid per capsule

**439450**

### Band Paste Refill

Two 13.3g (7.2ml) Paste Pak Cartridges of Fuji Ortho Band.

**001888**

### SC Standard Kit

Contains: One 40g powder, two 6.7ml bottles of liquid, mixing pad and scoop.

**439503**

### Ortho Paste Starter Pack

Fuji Ortho Band Paste Pak cartridges, 1 mixing pad, 1 paste pack dispenser and 1 mixing spatula

**439460**



## Pre-Bent

## Dispensing Tips

100 per package.

Yellow - 20 gauge

Grey - 22 gauge

Blue - 25 gauge

**PN-1228**

**PN-1230**

**PN-1231**

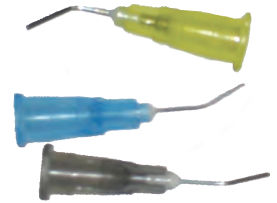

## Microbrushes®

100 per tube, 4 tubes per package.

Fine, Pink & Yellow

Assorted

Microbrush Dispenser Kit - Fine

Microbrush Dispenser Kit - Reg.

**MFA400**

**MBAS400**

**PF400-KIT**

**PR400-KIT**

Microbrush® is a registered trademark of Microbrush



## Mini Tip Applicators

144 per package.

Purple

Black

Blue

Yellow

Green

Red

**8202-10N**

**8202-11**

**8202-2**

**8202-3**

**8202-4**

**8202-5**



## Reliance®

## Brush Tips

1cm long handle.

250/pkg.

**BT250**

*Note: BT250 is not available for Canadian shipment.*



## Disposable

## Brush Tips

1.5cm long handle.

100/pkg.

**BBDT**

**Handle for 1.0 cm & 1.5 cm brush tips**

Ea.

**MMH**



## Economy

## Bonding Brushes

2" long handle.

400/pkg.

**BND400**



## Reliance®

## Benda-Brush

Benda-brushes are both economical and disposable. The 2" long brush has a ribbed handle for a better grip when applying adhesives or etchants.

250/pkg.

**BB250**

*Note: BB250 is not available for Canadian shipment.*





## Bonding Accessories

Reliance®

### Sponge Pellets

500/pkg. **SP**

Note: SP is not available for Canadian shipment.



Richmond®

### Cotton Pellets

2,000/box **100106**



Reliance®

### C.R. Syringe Mark II

Specifically designed for use with all Reliance® adhesives dispensed in a syringe tip.

Ea. **CRII**

Note: CRII is not available for Canadian shipment.



Reliance®

### Mixing Spatula

50/pkg. **S**



Economy

### Mixing Spatulas

50/pkg. **030-003**

Reliance®

### Mixing Wells

5/pkg. **MXW**



Disposable

### Mixing Wells

200/pkg. **900MW-2**



Reliance®

### Mixing Pads

2.25"x2.25" - 75 sheets  
Ea. **PADS**



Economy

### Mixing Pads

3"x5" - Ea. **707-0201-000**

2"x2" - 3/pkg. **707-0107-000**

3"x3" - 3/pkg. **707-1200-000**



Disposable

### Dappen Dish

200/pkg. **901DD**



Diadent

### Glass Dappen Dish

Ea. **601-001**



Disposable

### Bracket Tray

25/pkg. **BT2003-4T**

Aqua **BT2003-2X**

Blue **BT2003-1**

White



### Bracket Tray Holder

Holds 10 trays

- Organizes brackets for each patient
- Good for transporting
- Economical
- Dimensions: 6 1/4" H x 6 1/2" W x 3" D

Ea.

Smoke

Clear

**1013  
BK-TH**

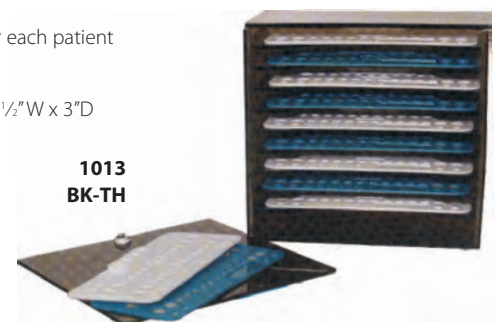

# Bonding Accessories

## Tidi® Saliva Ejectors

100/pkg.  
White **9306**  
Clear Blue **9307**



## Hygoformic Saliva Ejectors

100/pkg. **8111**



## Oral Evacuators

100/pkg.  
1/8" diameter **VE-1121**



## Beesure Saliva Ejectors

100/pkg. **954-9890**

## Beesure HVE Tips

100/pkg. **954-9891**

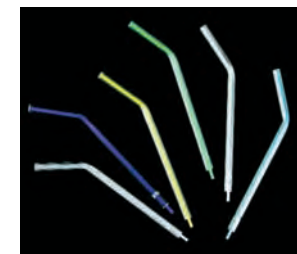

## Disposable Air/Water Syringe Tips

250/pkg.  
Clear/Clear **TST-0**  
White/Clear **TST-1**  
Blue/Clear **TST-2**  
Yellow/Clear **TST-3**  
Green/Clear **TST-4**  
Purple/Clear **TST-10N**  
Assorted Colors **TST-A**

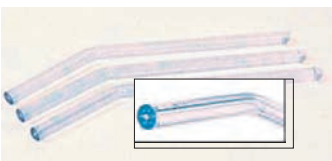

## Sani Tips

250/pkg. **STIPS**



## Metal Syringe Tips

5/pkg. **990-0038**

## Evacuation Saliva Ejector Traps

72/pkg. **8100**



## Evacuation Screens

144/pkg.  
2 1/8" Dia. - Blue **B8218-3**  
1 7/8" Dia. - Green **G8178-3**



## Disposable Tongue Blocks

Keeps the tongue away from the teeth during bonding and banding procedures. Soft plastic construction allows for easy trimming if needed.

50/pkg.  
**Scented**  
Medium **TB-D**  
Small **TB-DS**  
Regular - Super Soft **TB-SSD**  
Small - Super Soft **TB-SSDS**

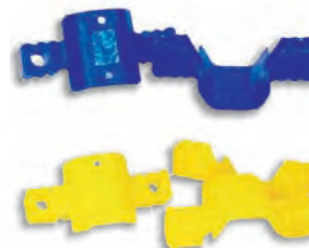

**Unscented**  
Medium **TBU-D**  
Small **TBU-DS**

## Absorbent NeoDrys™

50/pkg.  
Large **DYL**  
Small **DYS**



## Flexible Dry Tips

50/pkg.  
Small **161000-10**  
Large **161100-10**



## Absorbent Dry Angles

Large Plain - 160/Box **31L**  
Small Plain - 200/Box **31S**  
Large Foil - 160/Box **32LAG**  
Small Foil - 200/Box **32SAG**



## Bonding Accessories

### Cheek Retractor

- Soft material for patient comfort
- Full function design
- Includes handles which may be held by the patient
- Effective for intra-oral photos as well as bonding

Autoclavable - 120°C-248°F Max.

Ea. **CR-00-01**



### Cheek Retractor

Assure accessibility throughout the oral cavity. Stainless steel bow provides comfort and durability. Intraoral extensions fully retract cheeks. Dry heat and autoclave compatible.

Autoclavable - 177°C-350°F Max.

Adult (ea.)

Pediatric (ea.)

**CH1**

**CH2**



### TLC Retractor

Tongue, Lips & Cheek - designed to maximize intraoral exposure for any treatment procedure. Lips and cheeks are retracted simultaneously while the tongue is blocked. Soft material and gentle force insures patient comfort.

Autoclavable - 127°C-260°F Max.

2/pkg.

**TLC**



### Cheek & Tongue Retractor

A classic design provides comfortable cheek retraction while blocking the tongue. Available in two materials.



#### Disposable

10/pkg.

**PCKE-1D**

Autoclavable - 125°C-257°F Max.

Ea.

**PCKE-1**



"V" Cut

### Cheek Retractor

2/pkg.

Autoclavable

**BPR-1A**

Cold Sterilizable

**BPR-1D**

High Heat Sterilizable

**BPR-1S**



### Gingival Lip Retractor

Designed to provide vertical (gingival) lip retraction.

Autoclavable - 160°C-320°F Max.

2/pkg.

Adult

**LR-00-01**

Pediatric

**LR-00-02**



### Cheek Retractor

Autoclavable, 2/pkg.

Large

**EX-9002**

Small

**EX-9003**



Disposable

### Mouth Props

48/pkg.

Small

**EX-9060**

Medium

**EX-9050**

Large

**EX-9040**



Nola

### Dry Field Kit

The Nola Dry Field System completely eliminates saliva and fully exposes both arches making it ideal for all bonding applications. Autoclavable. Kits contain: Cheek Retractor, Suction Connections, Tongue Guard, Tubing.

Kits

Child, Red (ea.)

**300-400**

Adult, White (ea.)

**300-401**

Component Parts

Tongue Guard, Lg., White (ea.)

**300-403**

Tongue Guard, Sm., Red, (ea.)

**300-413**

Retractor, Lg., White (ea.)

**300-406**

Retractor, Sm., Red, (ea.)

**300-414**

Lip Retractor, Adult, (ea.)

**300-612**

Lip Retractor Child, (ea.)

**300-614**

Low Volume Adapt., 4/pkg.

**300-419**

High Volume Adapt., 4/pkg.

**300-420**

Y-Connectors, 4/pkg.

**300-408**

Silicone Tubing, 10/pkg.

**300-412**

Flexible Connector, Lg. (ea.)

**300-405**

Flexible Connector, Sm. (ea.)

**300-417**



*Note: Cheek retractor ends disassemble from bow for easy cleaning.*

Exclusively from G&H®

# Wet Field Bonding Adhesive



## SmartBond® Reliable Wet Field Bonding! Cyanacrylate Adhesive



**Bond High Cuspids Successfully with SmartBond!**

**SmartBond® kits include**

- Adhesive in syringe
- Etch in syringe
- Luer lock tips
- Microbrushes
- Mixing pads

**GREAT REFERRAL FOR ORAL SURGEONS!**

**SmartBond®** is a true one-step adhesive that bonds in a wet field. In fact, SmartBond® adhesive is activated only when it contacts moisture. Teeth are cleaned and etched for bonding as usual, but when the etchant is rinsed off, the next step is to bond. There is no drying, no sealants and there is no dry field to maintain.

SmartBond® activation begins when a bondable attachment is

delivered to the tooth and the adhesive contacts wet enamel. Five-second working time, five-minute bond set.

SmartBond® makes bonding in difficult locations easy. Partially or surgically exposed teeth, molars, lingually displaced teeth and high cuspids all can be successfully bonded with SmartBond®.

SmartBond is a registered trademark by Gestenco International AB, Sweden.

NOTE: SmartBond® is a filled cyanacrylate base adhesive. Care should be taken in dispensing, use and storage to avoid unintended adhesion.

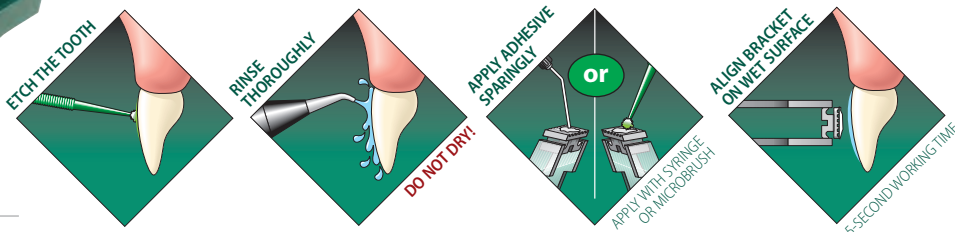

Refrigerated storage of SmartBond® recommended.

**SmartBond®**

- Instant cyanacrylate adhesive
- Mini-kit 3g (Includes 20 tips)
- Economy Kit 6g (two 3g) (Includes 40 tips)
- Trial Kit 1g (Includes 10 tips) (does not include etch or microbrushes)
- Refill Syringe 3g

- SM-000**
- SM-001**
- SM-010**
- SM-002**

**SmartBond® Component Parts**

- Luer Lock Tips (18 gauge - 40 per box)
- Etch Gel Syringe 6g
- Micro-Brushes (box of 50)
- Mix Pads

- SM-005**
- SM-003**
- SM-004**
- SM-006**

Note: SmartBond® is not available for Canadian shipment.

**EXTRUSION HOOKS** Mesh base assures reliable bonding, low profile limits irritation, 14k gold and titanium nitride-coated hook & chain reduces possibility of allergic reactions. 1" chain, .022" inner diameter.



- 14k Gold Extrusion Hook w/Chain (ea.) **EXHK14K**
- Stainless Steel Bondable 10/pkg. **EXHK**

**MICROBRUSHES** deliver just the right amount of liquid directly where desired, without waste. Four-pack assorted colors: one each of green, purple, orange and blue.



- 400 total brushes **MBAS400**

Microbrush® is a registered trademark of Microbrush

**Eruption Appliance  
Extrusion Chain w/Hook**

Bondable to cuspids impacted palatally or labially. The 1" (approx.) traction chain swings freely within the eyelet. The .022" inner diameter chain can be tied to the archwire with elastic thread or tubing to provide traction in the desired direction. 3.5mm diameter (flat) - 80 gauge foil mesh base assures reliable bonding, low profile limits irritation, 14k gold and titanium nitride-coated hook & chain reduces possibility of allergic reactions.



- Ea. **EXHK14K**

**Stainless Steel Bondable  
Extrusion Hook**



- Mesh pad for secure bonding.
- Package of (10) **EXHK**

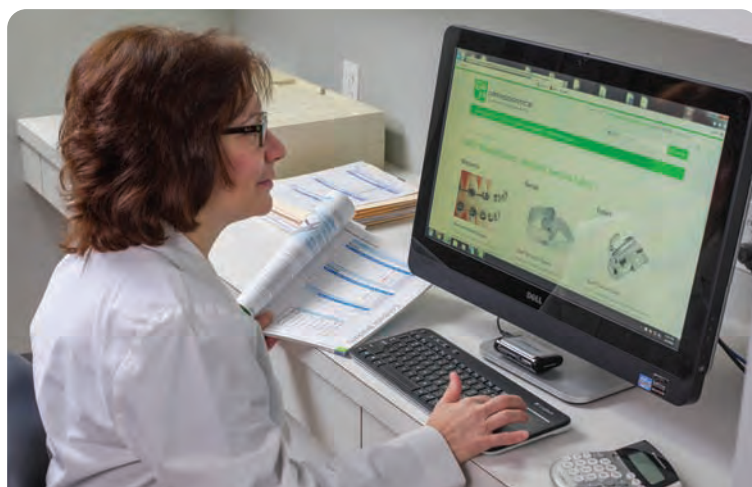

**Discover Your Orthodontic Buying Power!**

Your membership in the G&H OrthoClub® results in big savings. Enjoy buying-group savings on more than 6,000 brand-name clinical supplies including G&H manufactured products.

## G&H® Direct Bond Auxiliary Appliance Fabrication

### Mini-Mold Kits™

The various molds fabricate buttons, bite ramps, habit control spikes, temporary brackets, molar tubes, molar pads and create uniform lingual retainer bonds using light cure adhesives. Each mold is designed to pack with light cure adhesive, press against tooth, cure and peel away mold leaving a formed auxiliary on any tooth in just minutes. Compatible with Reliance® Assure®, Light Bond™ & Quick Cure™ adhesives.

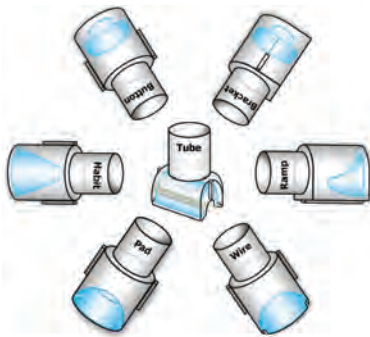

Wire Bonder Tips - Small and Large

**Starter kit** features three of each mold design, two application handles and instructions.

Ea. **MMASSTK**

### Individual mold designs

Kits include handle and instructions.

- Wire Bonder Kit Small (10 tips)
- Wire Bonder Kit Large (10 tips)
- Button Bonder Kit (10 tips)
- Bracket Bonder Kit (10 tips)
- Habit Control Bonder Kit (10 tips)
- Cuspid Ramp Kit (8 tips)
- Bite Ramp Bonder Kit (3mm) (8 tips)
- Bite Ramp Bonder Kit (5mm) (8 tips)
- Lateral Bonding Kit (4 tips)
- Lateral Bonding Kit (8 tips)
- Tube Bonder Kit (10 tips)
- Molar Pad Tip Kit (10 tips)
- Universal Bite Opening Kit (16 tips)  
(4 ea. 3mm, 5mm, cuspid ramp, & pad)

**MMWBKSM**  
**MMWBKLG**  
**MMBTNK**  
**MMBRKTK**  
**MMHCK**  
**MMCUSRK**  
**MMBITEK**  
**MMBITEK**  
**MMBITEK**  
**MMLATB4K**  
**MMLATB8K**  
**MMTBK**  
**MMMPTK**  
**MMUBITEOK**

Handle Only

**MMH**

## G&H® Direct Bond Occlusal Appliance

### Bite-Bumper™

Bite-Bumpers™ work to open deep bite cases by allowing the anteriors to ride up and out of occlusion. The Bite-Bumpers™ eliminate bond failures of brackets and are especially valuable with ceramic or self-ligating brackets.

The Bite-Bumpers™ are made of a composite polymer that is more comfortable, aesthetic and will increase biocompatibility in nickel sensitive patients.

Bite-Bumpers™ are bonded in the same manner as plastic or composite brackets and have a slotted mechanical bonding base.

10/pkg.

**BB-00-01**

*Note: Bite-Bumper™ is not available for Canadian shipment.*

Bite-Bumper is a registered trademark by Gestenco International AB, Sweden



The unique fixed "placement jig" guarantees the correct height on the lingual of the tooth and makes sure the two Bite-Bumpers™ are 100% parallel.



1. Put the placement-jig against the incisal edge.



2. Remove the jig.



3. Bite-Bumper™ ready.

*The placement-jig can be easily removed by hand or by a cutting instrument after bonding.*

# G&H® LED Curing Light

## LEDEX™ Portable LED Curing Light

The **LEDEX™** portable/rechargeable LED curing light bonds an entire arch without light intensity degradation or excess heat.

# Portable -and- Powerful

LEDEX™ LED Curing Light by Dentmate®

LEDEX™ is a trademark of Dentmate Technology Co., LTD



### LED Curing Light

- › Portable and lightweight
- › Easy to use - simple mode selection
- › Large LED display screen

### High-Intensity

- › 1000-1200 mw/cm<sup>2</sup>
- › 10-second bonds
- › Auto timer control

### Fiber-Optic Light Rod

- › Directs and concentrates light
- › Remains cool for patient comfort

### Continuous Power

Optional plug-in cord provides unlimited usage

- › Battery life = 200+ consecutive bonds
- › Plug-in option = Unlimited bonds
- › Battery recharges in as little as 2 hours



The use of UV protective eyewear is recommended for operators and patients during curing procedures with any light.

### Technical Specs

- Light wavelength between 440 and 480nm and intensity from 1,000 to 1,200mw/cm<sup>2</sup>. These characteristics enable the light to polymerize almost all photosensitive composite resins.
- The light rod is made from genuine optical fiber ensuring the highest possible intensity of light at the tip.
- Thermal protection circuit automatically shuts down light to prevent overheating.
- Automatic memorization of the last operation performed
- Cordless / cord combo operation allows continuous usage, - energy saving auto sleep mode

*"I find the LEDEX™ curing light from G&H® to be an effective part of our clinical bonding technique. The light's portability and high intensity make it an important part of our bonding success rate."*

Robert J. Gange, DDS, MS  
Windsor, CT



### LEDEX™ Portable LED Curing Light Kit

w/110v Power Cord (U.S.) or international adapter if required.

**Kit Includes:** Handpiece, Power Cord, Fiber-Optic Light Rod, UV Protective Shield, UV Protective Cone, Holder, Instruction Manual.  
Kit **DC100**

### Component Parts available separately

Hand Piece	<b>DC010</b>
Power Supply	<b>DC020</b>
Power Adapter (European)	<b>DC021</b>
Power Adapter (United Kingdom)	<b>DC022</b>
Power Adapter (Australia/New Zealand)	<b>DC023</b>
Fiber-Optic Light Rod (8mm tip)	<b>DC030</b>
UV Protective Shield (each)	<b>DC040</b>
Clean Covers 2"x10" (100/pkg.)	<b>DC090</b>
User Manual	<b>DC060</b>
Holder	<b>DC070</b>
UV Protective Cone (each)	<b>DC080</b>

### LEDEX™ Radiometer



Measure the light intensity of your Ledex™ dental curing light. 400 - 500nm spectral response range.

Ea. **DM100**

## G&H® Face Masks

### Protraction Face Mask

The adaptability of the G&H® Adjustable Protraction Face Mask allows for directional force application by adjusting the elastics engagement bar to deliver protractive force in the desired plane. Fully adjustable forehead and chin rests allow for adaptation to most patient's anatomical structure. The angle of traction is then determined by adjusting the elastics engagement bar to deliver horizontal, upward or downward forces as necessary. Face mask adjustments are made with an Allen wrench (2mm Allen wrench included). Padded forehead and chin rests offer comfort for extended wear and may be cleaned. Traction force application recommends 1/2" elastics with 16 oz. pull ratings, but alternate elastics may be used if differing forces are desired. Large - 10 1/4" Vert. Supp. Bar Ea.

**PFMLG**



#### Replacement Parts

##### Protraction Face Mask

Chin Cup w/2 pads **PFM001**  
 Forehead Piece **PFM002**  
 Allen Wrench (2mm) **PFA**  
 Replacement Pads **PFMRP**  
 Includes (2) Forehead & (2) Chin Cup



#### Extraoral Elastics

1/2" Bulk Pouches of 1,000 elastics in natural rubber latex  
 8 oz. **AX012B**  
 16 oz. **AXH12B**  
 See all Elastics on page 73.

### Reverse Pull Face Mask

The Reverse Pull Face Mask is available in two sizes and offers comfortable anchorage for protraction. The stainless steel frame is softened chin and forehead pads to minimize irritation and maximize patient acceptance. Facemasks allow for patient customization. All adjustments are made with an Allen wrench (1.5mm Allen wrench included with each mask). Both masks include: 2 forehead pads, 2 chin pads, replacement screws & Allen wrench.

Small  
Large

**RPFMSM**  
**RPFMLG**



#### Replacement Parts

##### Reverse Pull Face Mask

Chin Cup w/2 pads **RPFMCUP**  
 Allen Wrench **RPFMRS**  
 Replacement Pads **RPFMP**  
 Includes (1) Forehead & (1) Chin Pad

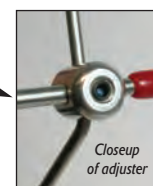

# G&H® Facebows and Lip Bumpers

## Color Coated Facebows

**Color Coated Facebows** have a durable color coating to resist peeling, cracking and discoloration. Available in five inner bow sizes\*. Medium outer

Facebows w/preformed omega loop - sizes 1-5



Sold individually

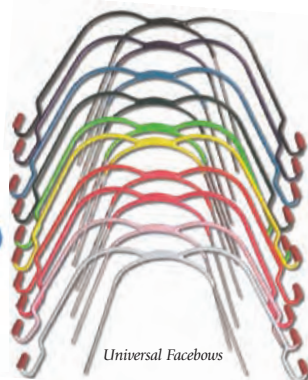

Universal Facebows

	Size 1 (83mm)	Size 2 (90mm)	Size 3 (97mm)	Size 4 (104mm)	Size 5 (111mm)	Universal
<b>Black</b>	CCFB101	CCFB201	CCFB301	CCFB401	CCFB501	CCFB001
<b>Blue</b>	CCFB102	CCFB202	CCFB302	CCFB402	CCFB502	CCFB002
<b>White</b>	CCFB103	CCFB203	CCFB303	CCFB403	CCFB503	CCFB003
<b>Orange</b>	CCFB104	CCFB204	CCFB304	CCFB404	CCFB504	CCFB004
<b>Dark Green</b>	CCFB105	CCFB205	CCFB305	CCFB405	CCFB505	CCFB005
<b>Lime Green</b>	CCFB106	CCFB206	CCFB306	CCFB406	CCFB506	CCFB006
<b>Yellow</b>	CCFB107	CCFB207	CCFB307	CCFB407	CCFB507	CCFB007
<b>Purple</b>	CCFB108	CCFB208	CCFB308	CCFB408	CCFB508	CCFB008
<b>Pink</b>	CCFB109	CCFB209	CCFB309	CCFB409	CCFB509	CCFB009

\*Size measurements are made distal to the omega loop to distal of the other loop along the inner bow.

◆ G&H® recommends using facebows only with properly designed safety release systems to prevent potential harm to patients.

## Standard Facebows

### Standard Facebows

in bright stainless steel. Five sizes plus Universal - Available in short or medium outer bow sizes.

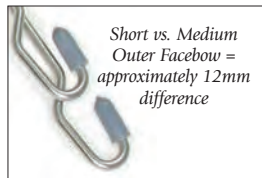

Short vs. Medium Outer Facebow = approximately 12mm difference

Sold individually

	Short Outer Bow	Medium Outer Bow
<b>SIZE 1</b> (83mm)	STFBSH01	STFB01
<b>SIZE 2</b> (90mm)	STFBSH02	STFB02
<b>SIZE 3</b> (97mm)	STFBSH03	STFB03
<b>SIZE 4</b> (104mm)	STFBSH04	STFB04
<b>SIZE 5</b> (111mm)	STFBSH05	STFB05
<b>UNIVERSAL</b>	STFBSH00	STFB00



Universal Facebow pictured

## Lip Bumpers

**Lip Bumpers** are precision shaped to relieve lip and cheek pressures and allow teeth to unravel quickly. Bumpers feature colored lip pad and include small ligating hooks for securing in place. Sizes 1-5\* and Universal, .045" diameter wire.

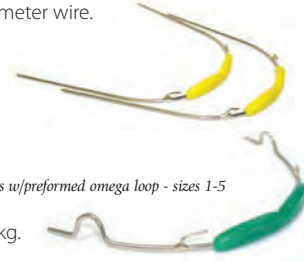

Lip Bumpers w/preformed omega loop - sizes 1-5

(2) per pkg.



Universal Lip Bumpers

Note: All lip bumpers have ligation hooks.

	Size 1 (83mm)	Size 2 (90mm)	Size 3 (97mm)	Size 4 (104mm)	Size 5 (111mm)	Universal
<b>Black</b>	CCLB101	CCLB201	CCLB301	CCLB401	CCLB501	CCLB001
<b>Blue</b>	CCLB102	CCLB202	CCLB302	CCLB402	CCLB502	CCLB002
<b>White</b>	CCLB103	CCLB203	CCLB303	CCLB403	CCLB503	CCLB003
<b>Orange</b>	CCLB104	CCLB204	CCLB304	CCLB404	CCLB504	CCLB004
<b>Dark Green</b>	CCLB105	CCLB205	CCLB305	CCLB405	CCLB505	CCLB005
<b>Lime Green</b>	CCLB106	CCLB206	CCLB306	CCLB406	CCLB506	CCLB006
<b>Yellow</b>	CCLB107	CCLB207	CCLB307	CCLB407	CCLB507	CCLB007
<b>Purple</b>	CCLB108	CCLB208	CCLB308	CCLB408	CCLB508	CCLB008
<b>Pink</b>	CCLB110	CCLB210	CCLB310	CCLB410	CCLB510	CCLB010
<b>Red</b>	CCLB111	CCLB211	CCLB311	CCLB411	CCLB511	CCLB011

\*Sizes are measured from distal of the omega loop to distal of the other loop.

## Safety Release Modules

### Safety Release Modules

Three force ranges to provide dependable retraction. Specially designed retention clip releases at 4-5 lbs. of outward force for patient safety.

5 pairs per pkg.

	450 gr	600 gr	750 gr
<b>Dark Blue</b>	SRDB450	SRDB600	SRDB750
<b>Black</b>	SRBK450	SRBK600	SRBK750





## G&H® Extraoral Accessories

### Cervical Neckpads

Two placement loops, for adjustability, ensure accuracy of fit. Manufactured with plush padding for comfort. 5/pkg.

Confetti  
Royal Blue  
Denim Blue  
Pink  
Black

**CPCF10**  
**CPRB10**  
**CPDB10**  
**CPPK10**  
**CPBK10**



Close-up of stitching detail

### High Pull Headcaps

Two sizes of headcaps, each with two placement loops, ensures accurate fit for patients.

5/pkg. - Nylon

	Small	Large
BLACK	<b>HPSBK5</b>	<b>HPLBK5</b>
ROYAL BLUE	<b>HPSRB5</b>	<b>HPLRB5</b>
RED	<b>HPSRD5</b>	<b>HPLRD5</b>



### Headgear Storage Cases

Velcro® closures conveniently store facebow and headgear to protect and organize. Perfect size for any configuration. Approximately 5.75" x 9.5" (15cm x 24cm) 5/pkg.

Black  
Red  
Royal Blue  
Green  
Purple

**HGSTBK**  
**HGSTRD**  
**HGSTRB**  
**HGSTGR**  
**HGSTPP**



Close-up of stitching detail

### Nylon Headgear Pouches

Sold individually

	Key Ring	Snap Clip
Black	<b>NJ208-03</b>	<b>N09/BLACK</b>
Green	<b>NJ208-04</b>	
Navy	<b>NJ208-06</b>	
Purple	<b>NJ208-05</b>	
Red	<b>NJ208-02</b>	
Royal	<b>NJ208-01</b>	



### Sof-Gear Chin Cup Headcaps

Ultra-comfortable and effective headcaps have chin cups attached with Velcro®. Headcap and chin cup assembly available as a set or as separate components.

5/pkg. - Royal blue only

	Junior	Regular
Sof-Gear chin cup with headcap	<b>SOF-CCJ</b>	<b>SOF-CCR</b>
Sof-Gear headcap	<b>SOF-HPJ</b>	<b>SOF-HPR</b>
Sof-Gear chin cup (one size)	<b>SOF-CC</b>	



# G&H® Fiber Reinforced Composite

## everStick® Ortho

everStick® Ortho incorporates a thousand glass fiber strands bound together with a pre-impregnated light cure adhesive that allows adaptation directly in the patient's mouth. The integrated fiber bundle is both malleable and tacky—perfect characteristics for close adaptation and positive retention prior to curing. .030" (0.75mm) passive diameter - flattens significantly during adaptation. Refrigerated storage recommended.

Box of (2) 12cm strands **EVERSTICK**

Note: everStick® is not available for Canadian shipment.



everStick and StickTech are registered trademarks of Stick Tech Ltd. Oy.

### Ideal for many applications:

- Lingual upper and lower retention
- Diastema retention
- Posterior anchorage
- Trauma or periodontal splinting
- Extraction site maintenance
- Segmented movement

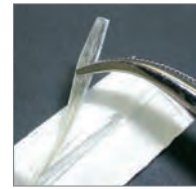

### The strength and durability of glass fibers combined with filled composite

- No frayed or messy fiber ends
- Easy-to-apply chairside method
- Bonds chemically & mechanically
- Compatible with all light cure composites
- Metal free & aesthetically pleasing
- Low profile and aesthetic
- Labial or lingual placement

### Clinical case photos of 14-year old female\*

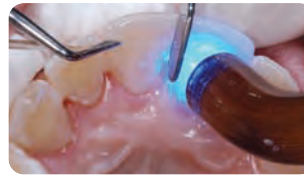

\*Typical FRC application by Vittorio Cacciafesta, DDS, MSc, PhD and M. Francesca Sfondrini, MD, DDS – Italy

## Fiber Reinforced Composite Companion Products



### FRC Placement Tool

A double-ended spatula that is angled for ease of application and curing of FRC bonded lingual retainers and splints.

Ea. **PLACE**



### Flow Tain®

A flowable light cure composite with low viscosity making it ideal for bonded lingual retainers and splints. See page 109 for full information.

Medium viscosity **FT**  
Light viscosity **FTLV**



### LEDEX™ Portable LED Curing Light

A powerful LED curing light - maintains light intensity without excess heat. See page 119 for full information.

Ea. **DC100**



## Full Line Quality Orthodontic Products

Orthodontists have one of the most important jobs – bringing renewed self-confidence and pride to every patient through improved smiles.

Order our full line of products at: [GHOrthodontics.com](http://GHOrthodontics.com)

**G&H®**  
**Finishing Appliance**



The G&H® **NEOsmile™** is a preformed tooth positioner that will idealize the patient's finishing occlusion upon debanding. The NEOsmile™ will maintain a Class I ideal relationship and provide some buffering against TMJ related irritations. Each NEOsmile™ incorporates molded air holes for unencumbered breathing. Like a custom tooth positioner, the NEOsmile™ is seated on the upper arch posterior on one side and stretched to the opposite side. Then the patient can gently clench to fully occlude into the appliance.

**Typical Indicated Applications**

Generalized spacing may be corrected by staging sizes of the NEOsmile™. When generalized spacing is present and NEOsmile™ is fitted to the patient, it is typically recommended to use a size smaller than patient's measured size. Patients with moderate generalized spacing may require the use of two concurrent NEOsmile™ positioners in incrementally smaller sizes to achieve ideal results.

Moderate space closure, band spaces, minor diastema closure, 3-4° torque, 5-8° rotation, and minor to moderate uprighting can be achieved where space is available.



**Selecting the Proper Size**

Determine the patient size for the NEOsmile™ by measuring the millimeter span from distal of upper cuspid to distal of opposite cuspid along the incisal edges.

The NEOsmile™ comes in three permutations. For instance, the Non-Extraction series can be used with excellent results for patients with either first or second molar extraction. For bicuspid extraction, the NEOsmile™ can be used for first or second bicuspid extraction cases. The NEOsmile™ is available in the following kits or individually in one millimeter increments as indicated.

	Non-Extraction	Four Bicuspid Extraction	Two Upper Bicuspid Extraction
<b>Individual</b>	<b>PFTPS0*</b> 42-58mm	<b>PFTPS4*</b> 45-60mm	<b>PFTPS2*</b> 45-56mm
<b>Kit of 10</b> Includes ruler	<b>PFTPS010</b> 45-54mm	<b>PFTPS410</b> 47-56mm	<b>PFTPS210</b> 46-55mm

\*Insert preferred millimeter size, available in 1mm increments.

**MM Ruler**  
Our unique double-sided ruler features a hole to engage a post or hook making space measurement quick, easy and accurate!

20/pkg. **RULERMGG**



G&H® Orthodontics

# PARAGON™ INSTRUMENTS

## FEATURES INCLUDE:

- Tungsten Carbide inserted tips on all cutters for extremely high durability and superior performance. The tips may be replaced over time at a fraction of the cost of replacing the entire instrument.
- Surgical grade 420-Barstock stainless steel handles and stocks designed to withstand the rigors of repeated sterilization while maintaining their aesthetic finish.
- Diamond-honed cutting edges that stay sharp longer and are precisely aligned, making for a highly efficient, long lasting wire cutter.
- All Paragon™ Instruments are 100% solid stainless steel and are hand finished to a satin luster. In addition to corrosion resistance, this non-glare surface is easy to clean and will always look great.
- Precision-machined components, combined with our exclusive orbit forming process, create a smooth working hinge without shins, and keep the instrument's tips in proper alignment. With regular lubrication, joints will work smoothly for years.
- The sizes, shapes, handle lengths, and weights are optimized for comfort and confidence.

### Mini Distal End Safety Hold Cutter with T.C.

Safely cuts and securely holds distal ends of arch wires. Precise cutting edges and tip angle allow arch wires to be cut close to the distal end of buccal tubes.

**Maximum Cutting Capacity**

Rectangular wire up to .021" x .025"  
(0.56 x 0.71 mm)

Round wire up to .020" (0.51 mm)

Ea. **IPL1-002**



### Flush Cut Distal End Cutter with T.C.

The flush cut feature allows the archwire to be cut flush with the end of the buccal tube, eliminating the possibility of patient discomfort resulting from archwire protrusion.

**Maximum Cutting Capacity**

Archwire up to  
.021" x .025" (0.56 x 0.64 mm)

Ea. **IPL1-003**



### Hard Wire Cutter with T.C.

T.C. inserts for extra hardness to ensure precision cutting of archwires or pins.

**Maximum Cutting Capacity**

Rectangular wire up to .022" x .028"  
(0.56 x 0.71 mm)

Round wire up to .020" (0.51 mm)

Ea. **IPL1-006**



### Pin and Ligature Cutter with T.C.

This cutter is designed for easy and efficient cutting of pins and ligatures. The cutting edges are diamond-honed.

**Maximum Cutting Capacity**

Soft wire up to .015" (0.40 mm)

Ea. **IPL1-005**



## G&H® Instruments | PARAGON™

### Tweed Style Arch Forming Pliers

This plier is ideal for bending square and rectangular wire. Edges are radiused and hardened to prevent wire scoring and to preserve a smooth contact area with the wire. Blades are parallel when opened to .010 to ensure accurate 90° bends.

#### Bends wire up to

.022" x .028" (0.56 x 0.71mm)

.075" (1.9mm) Ea.

**IPL1-009**

.050" (1.2mm) Ea.

**IPL1-010**



### Weingart Utility Pliers

Special features incorporated in Paragon™ Weingart style pliers make this one of the most popular. Matching serrated tips hold wires firmly at a convenient working angle. Carefully tapered beaks fit easily between brackets and are rounded for safety and comfort.

#### Holds wire up to

.022" x .028" (0.56 x 0.71mm)

Ea.

**IPL1-013**



### Weingart Utility Pliers (Slim)

An efficient utility plier similar to model IPL1-013 but with specially designed narrow tips for better intraoral accessibility.

#### Holds wire up to

.022" x .028" (0.56 x 0.71mm)

Ea.

**IPL1-012**



### Weingart Pliers (Angled)

Similar to the IPL1-013 but with 45° angled tips. Matching serrated tips hold wires firmly at a convenient working angle.

#### Holds wire up to

.022" x .028" (0.56 x 0.71mm)

Ea.

**IPL1-014**



### HOW Utility Pliers

A versatile utility plier with long tapered tips. The 2.0mm diameter tips are serrated to prevent slippage. The tips are rounded for patient comfort and safety.

Ea.

**IPL1-015**



### HOW Utility Pliers (Angled)

Similar to the IPL1-015 but with 45° angled tips and 2.0mm gripping pads for convenient access to lingual and other difficult to reach areas.

Ea.

**IPL1-016**



### Jaraback Pliers

Ideal for precise bending of light wires. Precision grooves assure accurate bending and closing loops. Flat tip is serrated for firm gripping.

#### For wires up to

.020" (0.51mm)

Ea.

**IPL1-017**



### Three Jaw Pliers

Precision aligned tips are gently rounded for consistent contouring and bending without damaging the archwire. One-piece construction of the double tip ensures superior strength.

#### For wires up to

(.036" (0.91mm)

Ea.

**IPL1-020**



### Tweed Loop Forming Pliers

Ideal for making consistent, uniform loops. Tip has three sections of .045", .065", and .090" with matte finish to prevent wire slippage.

#### For use with round and square wires up to

.021" x .025" (0.55 x 0.64mm)

Ea.

**IPL1-021**



### Posterior Band Removing Pliers

The plastic pad rests on the occlusal surface of the molar, which places the removing tip in the perfect position to catch the gingival edge of the band.

Replacement plastic pads are available.

Ea. **IPL1-022**



### Adhesive Remover Pliers

Designed to remove direct bond brackets quickly and comfortably. The plastic pad rests against the incisal/occlusal edge of the tooth to provide leverage. The sharp tip fits under the bracket flange. Can also be used to remove remaining adhesive.

Replacement plastic pads are available.

Ea. **IPL1-023**



### Bird Beak Pliers

The most popular and versatile pliers for working with round wire up to 0.30" (0.76mm) in diameter. The round beak is precision ground to a perfect cone, .025" (0.64mm) at the tip. The beaks are parallel at .020" (0.51mm) opening.

Long Tips Ea.  
Short Tips Ea.

**IPL1-026**  
**IPL1-027**



### Light Wire Pliers

Longer, more gradually tapered beaks than the Bird Beak Pliers (IPL1-027). The longer beaks make it easier to bend small diameter loops.

**For wires up to .016" (0.41mm)**

Long Ea. **IPL1-030**  
Short Ea. **IPL1-031**



### Direct Bond Bracket Removing Pliers (Angled)

Designed for fast, safe and comfortable removal of direct bond brackets. The angled tip allows for easy access to difficult anterior and posterior areas.

Ea. **IPL1-035**



### Hook Crimping Pliers

Designed to crimp auxiliary stops, hooks and posts to archwires. The slotted design fits over the base of the hook while holding it tight during crimping.

Ea. **IPL1-042**



### Stop "V" Bend Pliers

Designed for making 1mm "V" bends to shorten archwires or provide a positive stop.

**For wires up to .019" x .025"**

Ea. **IPL1-045**



### Wire Contouring Pliers

The smooth inner surface allows for subtle contouring and forming of archwires. Forms without scoring or torquing. Perfect for accentuated curves.

**For wires up to .022" x .028" (.025 x .071mm)**

Ea. **IPL1-048**



### Hollow Chop Pliers

This contouring plier's mated concave and convex jaws are useful in reshaping archwires and forming palatal arches.

**For round wire .014" - .036"**  
**For rectangular wire .022" - .028"**

Ea. **IPL1-049**



### Finishing Pliers

Special double-sided offset head forms bayonet bends. Forms right-hand or left-hand step-up or step-down bends. For wires up to .021" x .025"

1/4 mm Ea. **IPL1-051-.025**  
1/2 mm Ea. **IPL1-051-.050**  
3/4 mm Ea. **IPL1-051-.075**  
1 mm Ea. **IPL1-051-.100**



Make bends without removing the wire!



## G&H® Instruments

### Schure Band Seater

This double ended instrument has a square and serrated end for pushing and seating molar bands, and a scaler on the opposing end for cleanup or removal of adhesives and cements. One-piece construction provides for durability and thorough sterilization. Serrated handle for firm grip.

Autoclavable up to 370°F/188°C

Ea. **ISP-042**



### Band Seater

Simplifies cement cleanup and band adaptation. The seating tip is serrated on four sides and end.

Ea. **BSEAT**



### Mershon Band Pusher

Used for seating and burnishing bands into their final position. The squared and serrated tip provides a secure grip on band attachments, while the large handle provides for the firmest grip possible. One piece fabrication provides durability and complete sterilization. Cold sterilized.

Ea. **ISP-046**



### Double Ended Ligature Director

This instrument is very useful when tucking or pushing elastics. The dual straight and curved ends allow for ease of intraoral placement and use. Solid stainless steel.

Autoclavable up to 370°F/188°C

Ea. **ISP-044**



### Ligature Tier

This instrument is designed for faster and easier placement of elastic ligature ties on all styles and sizes of edgewise brackets. The smooth, rounded tips will not damage or cut elastomeric ligatures. Solid stainless steel.

Autoclavable up to 370°F/188°C

Ea. **ISP-045**



### Explorer

This double ended explorer is helpful when removing elastic chain and ligature ties. The tips are very durable. Tempered stainless steel.

Autoclavable up to 370°F/188°C

Ea. **ISP-072**



### Distal Bender

Cinchback bends are quick and easy. Simply insert the tip over the distal end of the archwire and twist in the desired direction. Straightening cinchback bends are done with equal efficiency, thus reducing the time required for changing the archwires.

Single-ended, Ea.  
Double-ended, Ea.

**ISP-108**  
**DEDEBEND**



### Force Gauge Dynamometer

Precisely measures forces exerted by elastics, archwires, and coil springs. Double-ended calibrated shaft. Supports a force range of 28-450 grams.

Ea. **ISP-352**



### Swivel Head Bracket Positioner

This stainless steel positioning device features four bracket height measurements: 3.5, 4.0, 4.5, and 5.0. Adjustable for use on both anterior and posterior teeth. Hinged tip adjustable to 45°. Works with .022 and .018 bracket systems.

Autoclavable up to 370°F/188°C

Ea. **ISP-069**



### Standard Bracket Holder

Reverse action holds brackets and tubes without finger pressure for easier bonding.

Autoclavable up to 370°F/188°C

Ea. **ISP-048**



### Fine Tip Bracket Tweezer

Fine, angled tips allow for precise positioning. Light reverse action allows for easy removal of the instrument after placement of the attachment.

Autoclavable up to 370°F/188°C

Ea. **ISP-056**



### Deluxe Bracket Holder

This reverse action stainless steel tweezer holds brackets and buccal tubes with thin, angled tips which are designed to slip under bracket and tube tie wings. It is ideal for miniature attachments.

Autoclavable up to 370°F/188°C

Ea. **ISP-057**



### Bracket Holder with Bracket Aligner

Reverse stainless steel tweezer incorporates a bracket aligner on the opposite end. This double ended instrument makes correct bracket placement easier by using the alignment tip in the archwire slot and adjusting alignment. It can also be used for flash removal.

Autoclavable up to 370°F/188°C

Ea. **ISP-060**



### Keat Buccal Tube Tweezer

The curved body of the tweezer provides an unobstructed view for easy and precise placement of buccal tubes.

Autoclavable up to 370°F/188°C

Short handle, Ea. **ISP-070**  
Long handle, Ea. **KBTPLG**  
Reverse action, Ea. **KBTPSHR**



### Mosquito Hemostat

This locking hemostat has extremely fine tips for the engagement of ligature and chain elastics. The stainless steel has an aesthetic brushed satin finish.

Autoclavable up to 370°F/188°C

Ea. **ISP-055**



### Mosquito Hemostat with Hook

Similar to the standard version, but with a hook at the tip to avoid slippage when engaging elastic ties and chain. Tempered steel tip for strength and durability.

Autoclavable up to 370°F/188°C

Ea. **ISP-062**





## G&H® Instruments

### Mathieu Hemostat

Features small, highly serrated tips with the addition of a hook at the tip designed to avoid slippage when engaging elastic ties and chain. With Tungsten Carbide inserts.

Autoclavable up to 370°F/188°C

Without Hook, Ea. **ISP-996**  
With Hook, Ea. **ISP-996H**  
Narrow w/o Hook, Ea. **MNHNT**



### Separating Plier

This instrument is designed to stretch separating elastics for ease of placement between tooth contacts. The curved beaks allow for easy use in the posterior segment.

Autoclavable up to 370°F/188°C

Ea. **ISP-050**



### Boone Gauge

This positioning device allows the orthodontist to precisely gauge proper bracket height during placement. (3.5, 4.0, 4.5, 5.0)

Metal - autoclavable up to 370°F/188°C.

Ea. **SSBRACG**



### Bite Stick

This high-heat bite stick is compatible with any conventional sterilization method, including Dry Heat up to 350°F. Serrated stainless steel insert ensures positive contact without slipping.

Ea. **BSHH100**

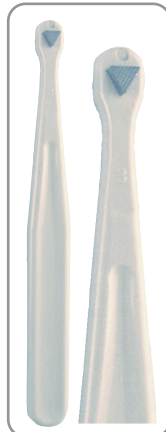

### Therma-Stick™

A hollow tube with a special tip that is filled with water, then frozen. Place the frozen tip against NiTi wire (particularly M5™ Thermal NiTi) to soften the wire for easy engagement in the bracket. May be used directly in the patient's mouth.

Ea. **THSTK**



### FRC Placement Tool

A double-ended spatula that is angled for ease of application and curing of FRC bonded lingual retainers and splints.

Ea. **PLACE**

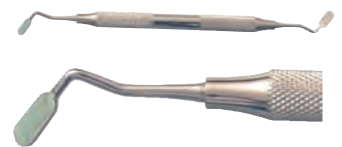

### White Acrylic Plier Rack

Ea. **1009**



### Dual Plier Rack

Ea. **1010**

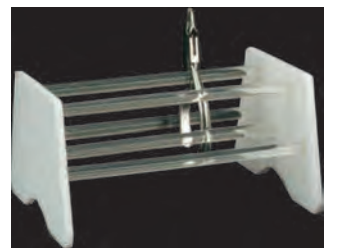

### Single Plier Rack

Ea. **1011**

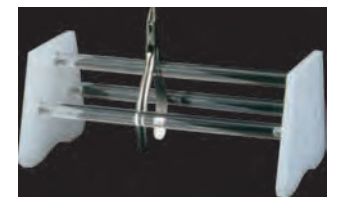

### Acrylic Instrument Rack

Ea. **1012**

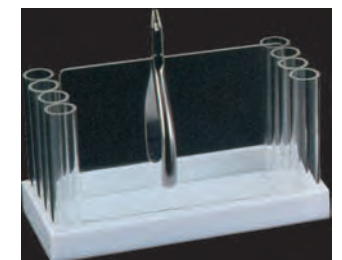

# G&H® Instruments

## Plier Rack

Our Plier Rack neatly organizes most any orthodontic plier sets. Aluminum rods with plastic ends allow for easy wipe down. Holds approximately 20 instruments.

Ea. **PLRK020**



## Combination Plier Rack

This beautiful rack accommodates 7 pliers, and also has 7 vertical storage holes for explorers, mouth mirrors, mosquito, and Mathieu instruments. The open front area is also ideal for instruments and auxiliaries.

Ea. **S413-01**



## Round Instrument Holder

This durable, clear Lucite 4" cylinder easily holds up to 15 pliers, while an inner 1 1/4" cylinder stores narrow instruments such as scalars, explorers, and band seaters.

Ea. **S411-01**



## Upright Plier Rack

Clear acrylic plier rack allows you to neatly organize your pliers. Holds up to 12 pliers and measures 6" x 4" x 6".

Ea. **S412-01**



## Instrument Stain Remover

Powder formula removes stains, tarnish and restores luster.

Ea. **3-740**



## Lavoric® Surgical Milk

A concentrated pre-autoclave dip that extends the life of valuable instruments. The non-toxic, odor-free formula inhibits rust and lubricates all hinged instruments.

Quart **862-2310**  
Gal. **862-2312**



## L&R Barrier Milk

Helps prevent corrosion of instruments when used prior to sterilization. Provides complete protection from rust and keeps hinged instruments moving smoothly.

8 oz. spray **00139**  
Gal. **076**



## Spring Measuring Gauges

Our exclusive TAD and CC **Spring Measuring Gauges** determine the spring size and force value needed. Landmark extensions are highlighted in red on side (A) and corresponding spring suggestions are on side (B). The hole in the gauge represents a spring eyelet or ligature and can be engaged over a hook or TAD screw to accurately measure distance between anchor points.

20/Box  
CC Measuring Gauge **CCOFMG**  
TAD Measuring Gauge **CCOTMG**



## Millimeter Ruler

Our unique double-sided 60mm or 80mm rulers feature a hole to engage a post or hook making space measurement quick, easy and accurate.

20/Box  
60mm Ruler **RULERMG**  
80mm Ruler **RULERMGG**

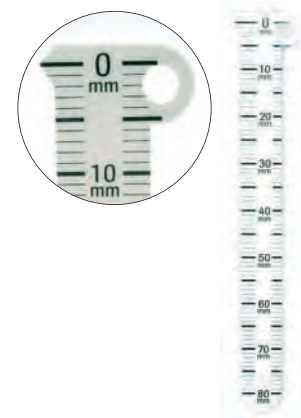

## Overbite Ruler

This aluminum ruler makes for easy measuring of overbite.

Ea. **OP-11-00**



## G&H® Instruments

### Digital Caliper

Precise measurements with easy-to-read digital display. Durable stainless steel construction, metric/Inch change over (true conversion), zero setting (zero setting at any position within the measuring range), measures external and internal dimensions, depth, and steps. Comes fully assembled and ready to use - also includes (1) replacement battery and instructions.



Ea. **DIGICALIP**



Silicone

### Instrument Code Rings

Suitable for all sterilization processes.

60/pkg.	Regular 1/8"	Large 1/4"
Aqua	<b>202CD-4X</b>	<b>205CD-4X</b>
Dark Blue	<b>202CD-2X</b>	<b>205CD-2X</b>
Mauve	<b>202CD-10</b>	<b>205CD-10</b>
Neon Yellow	<b>202CD-3N</b>	<b>205CD-3N</b>
Red	<b>202CD-5N</b>	<b>205CD-5N</b>
Tangerine	<b>202CD-12</b>	N/A
White	<b>202CD-1</b>	<b>205CD-1</b>



#### Code Ring Kits - Assorted colors

Regular - 80 pieces	<b>202CD-A</b>
Large - 80 pieces	<b>205CD-A</b>

### 110v Warm Air Tooth Dryer

Removes excess tooth surface moisture.

Ea. **300-501**

**Nozzle with Elbow** - Ea. **300-503**

**Dryer Elbows** - Ea. **300-504**



### Low-Speed Air Motor "E" 20,000 RPM

Ea. **111-3554**

*Note: Not available for Canadian shipment.*



Low-Speed

### Mini 1-Piece Motor W/Nose Cone 20,000 RPM

Ea. **111-1334**

*Note: Not available for Canadian shipment.*



Low-Speed

### Straight Nose 20,000 RPM 1:1

Fully autoclavable.

Ea. **111-0000**

*Note: Not available for Canadian shipment.*



Low-Speed

### Prophy Nose Reducer 5,000 RPM 4:1

Fully autoclavable.

Ea. **111-0010**

*Note: Not available for Canadian shipment.*



Low-Speed

### Contra Angle Full 360° Swivel 1:1

Fully autoclavable.

Ea. **111-0050**

*Note: Not available for Canadian shipment.*



Low-Speed

### Reduction Contra Angle 4:1

Due to its 4:1 reduction the planetary gears maintain increased torque at a lower revolution. Fully autoclavable.

Ea. **111-0054**

*Note: Not available for Canadian shipment.*



Hi-Speed

### Air King Push Button Handpiece

Ea. **120-0344**

*Note: Not available for Canadian shipment.*



Hi-Speed

### Air King Mini Push Button Handpiece

Ea. **120-0344M**

*Note: Not available for Canadian shipment.*



Hi-Speed

### Air King Regular Handpiece

Ea. **120-0360**

*Note: Not available for Canadian shipment.*



# G&H® Instruments

## High-Speed Non-Optic Handpiece

Ceramic ball bearings, premium spindle, unequaled low noise level.

Ea. **MK-PLBK**  
*Note: Not available for Canadian shipment.*



## Hi-Speed Air King Mini Standard Regular Handpiece

Ea. **200-0030**  
*Note: Not available for Canadian shipment.*



## High/Low Speed Handpiece Lubricating Pen Oiler

Autoclavable & non-toxic lubricating oil. ¼ oz. pen oiler.

2/pkg. **130-2172**



## Once-A-Day Handpiece Lubricant

Ea. **932-9800**



## Disposable Propphy Angles

Non-latex.  
Firm - 100/pkg. **9539170**  
Soft - 100/pkg. **9539850**  
Super Soft - 144/pkg. **9539650**



## Disposable Propphy Angles

Non-latex.  
Soft - 100/pkg. **953-3590**  
Hard - 100/pkg. **953-3598**



## Twist Propphy Angles

100/pkg.  
Firm **TPAFC**  
Soft **TPASC**  
Tapered Brush **TPATB**



## Sparkle Propphy Angles

Firm Cup White - 500/pkg. **TPASFCS**  
Soft Cup Lavender - 100/pkg. **TPASSC1**  
Firm Cup White - 100/pkg. **TPASFCS**  
Soft Cup Lavender - 500/pkg. **TPASSC5**



## Propphy Cups

144/pkg.  
**Screw Type**  
Firm **9539400**  
Soft **9539820**  
**Knob Type**  
Firm **9539450**  
Soft **9539810**  
Superflex **9539620**



## Latch-Type Propphy Cups

144/pkg. **24-40514**



## Gelato Propphy Paste

200/pkg.  
Coarse Grit / Fruit **24-02777**  
Coarse Grit / Mint **24-03077**  
Medium Grit / Fruit **24-02677**  
Medium Grit / Mint **24-02277**



Assorted fruit flavors consist of: Bubble Gum, Cherry, Mint, Pina Colada, Orange Sherbet, Raspberry.

## Plak Smaker Brilliance Propphy Paste

No fluoride or flavor.  
200/pkg. **10664**



## Individual Cups Sparkle "Free" Propphy Paste

Fluoride-FREE, Dye-FREE, Gluten-FREE  
200/pkg.  
Coarse Grit / Fruity Gum **UPSFCE**  
Coarse Grit / Spearmint **UPSFCS**  
Medium Grit / Fruity Gum **UPSFME**  
Medium Grit / Spearmint **UPSFMS**



## G&H® Instruments

Individual Cups

### Pumice Preppies

Contains no flavoring agents, oils or fluoride. Leaves no residue. 2g cups.

100/pkg. **03400**



Fine/Medium/Coarse

### Pumice

Fine / 50 lb. **32662**  
 Medium / 3.5 lb. Jar **03476**  
 Medium / 20 lb. **03492**  
 Medium / 50 lb. **32654**  
 Coarse / 3.5 lb. Jar **03417**  
 Coarse / 20 lb. **03433**  
 Coarse / 50 lb. **32646**



Dual Sided - Abrasive both sides

### Lightning Strips

.30 mm thick x 5 7/8" long  
12/pkg.

2mm/Fine **630-81330**  
 3mm/Fine **630-81350**  
 4mm/Fine **630-81370**  
 2mm/Medium **630-81390**  
 3mm/Medium **630-81410**  
 4mm/Medium **LSDSM4M**  
 6mm/Medium **LSDSM6M**  
 8mm/Medium **LSDSM8M**  
 3mm/Coarse **630-81470**  
 4mm/Coarse **630-81490**



Single Sided - Abrasive one side

### Lightning Strips

.21 mm thick x 5 7/8" long  
12/pkg.

2mm/Fine **620-81010**  
 3mm/Fine **620-81030**  
 4mm/Fine **620-81050**  
 2mm/Medium **620-81070**  
 3mm/Medium **620-81090**  
 4mm/Medium **LSSSM4M**  
 6mm/Medium **LSSSM6M**  
 8mm/Medium **LSSSM8M**  
 3mm/Coarse **620-81150**  
 4mm/Coarse **620-81170**



Flexiview

### Interproximal Strips

10/pkg.  
 Single-sided, 5 7/8" long x 0.13mm thick  
 Medium grit, Narrow **5VNM1**  
 Medium grit, Wide **5VWM1**



Green

### Mounted Stones

Silicon carbide grit: fast, cool cutting, economical to use, excellent durability.

12/pkg.  
 Points I-5 **1631194**  
 Points T-4 **1631196**  
 Points P-2 **1631199**  
 Points W-3 **1631200**  
 Points W-6 **1631201**  
 Points F-2 **1631203**  
 Points I-3 **1631205**  
 Points I-6 **1631210**

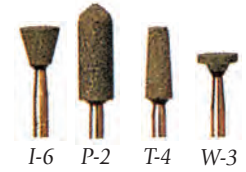

Reliance/Renew System

### Burs & Points

18 fluted friction grip mounted and designed to be the quickest, safest, method for bulk removal of all types of bonding adhesive after bracket removal. Ea.

Bur #118S **RSB**  
 Bur #218 **RSB2**  
 Bur #118L **RSBL**  
 Bur #815 **RSB815**  
 Ball shaped ideal for lingual surface.

#### Bur 118S



Short cutting surface with rounded end.

#### Bur 118L



Long cutting surface with rounded end.

#### Bur 218



Long tapered cutting surface.

### Points

Will remove thin layers of adhesive, clean and polish the enamel with no damage. 12/pkg.

Point #383  
 Friction Grip  
 Straight Handpiece  
 Latch

**RSPFG**  
**RSPHP**  
**RSPL**



Silver

### Carbide Burs

Ea.  
 88A Carbide Bur **1201820**  
 51A Carbide Bur **1201930**  
 84T Carbide Bur **1201830**  
 52D Carbide Bur **1201910**  
 SP-1 Carbide Bur **1201955**  
 63B Carbide Bur **1201880**  
 61A Carbide Bur **1201890**  
 82T Carbide Bur **1201850**  
 41P Carbide Bur **1201950**  
 33C Carbide Bur **1201980**

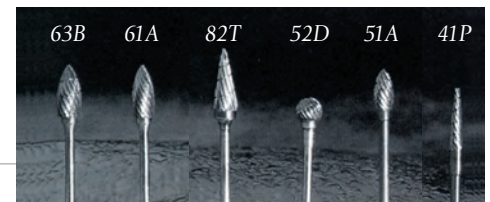

Note: Not all Carbide Burs are available for Canadian shipment. Contact customer service.

# G&H® Instruments

Carbide

## Lab Cutter

Ea.

- Coarse Cross-Cut **406001**
- Coarse Cross-Cut **406102**
- Coarse Cross-Cut **406302**
- Coarse Cross-Cut **406801**
- Coarse Cross-Cut **406901**
- Coarse Cross-Cut **407001**
- Coarse Cross-Cut **407401**
- Medium Cross-Cut **302001**
- Medium Cross-Cut **302202**
- Medium Cross-Cut **302302**
- Medium Cross-Cut **302801**
- Medium Cross-Cut **302901**
- Medium Cross-Cut **303001**
- Medium Cross-Cut **303101**
- Fine Cross/Spiral Cut **700801**
- Medium Spiral-Cut **100801**
- Medium Spiral-Cut **101001**

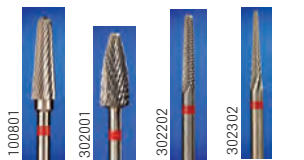
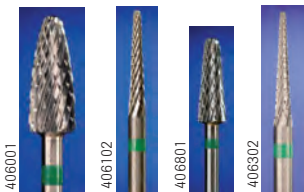

Alpen

## Swiss Diamond Burs



### Aesthetic Finishing Burs - 5/pkg.

- 133.010.4 Fine Finishing Bur
- 134.014.6 Fine Finishing Bur

**R133F010FG**  
**R134F014FG**



### Football Pointed Burs - 5/pkg.

- 368.016.3.5 Coarse Football Pointed Bur
- 368.016.3.5 Fine Football Pointed Bur
- 368.020.5 Coarse Football Pointed Bur
- 368.020.5 Fine Football Pointed Bur
- 368.023.5 Coarse Football Pointed Bur
- 368.023.5 Fine Football Pointed Bur

**R368C016FG**  
**R368F016FG**  
**R368C020FG**  
**R368F020FG**  
**R368C023FG**  
**R368F023FG**



### Football Burs - 5/pkg.

- 379.016.3.5 Coarse Football Bur
- 379.016.3.5 Fine Football Bur
- 379.018.3.5 Coarse Football Bur
- 379.018.3.5 Fine Football Bur
- 379.023.5 Coarse Football Bur
- 379.023.5 Fine Football Bur

**R379C016FG**  
**R379F016FG**  
**R379C018FG**  
**R379F018FG**  
**R379C023FG**  
**R379F023FG**



### Round Wheel Burs

- 909-1.5.040.1.5 Coarse Rnd. Wheel - 5/pkg.
- 909-1.040.1 Coarse Rnd. Wheel - 5/pkg.
- 909.055.2 Coarse Rnd. Wheel - 5/pkg.

**R90915C040FG**  
**R9091C040FG**  
**R909C055FG**



Gold

## Trimming and Finishing Burs

10/pkg.

- Flame - Diameter 1.2 **7102**
- Flame - Diameter 1.4 **7104**
- Flame - Diameter 1.8 **7106**
- Needle - Diameter 0.9 **7901**
- Needle - Diameter 1.0 **7902**
- Needle - Diameter 1.2 **7903**
- Bullet - Diameter 1.0 **7802**
- Bullet - Diameter 1.2 **7803**



Gold

## Metal Cutting Carbide Burs

10/pkg.

- Round-End Fissure - Dia. 1.0 **G/1557**
- Round-End Fissure - Dia. 1.2 **G/1558**

*Note: G/1557 and G/1558 are not available for Canadian shipment.*



Gold

## Carbide Burs

Ea.

- 84T Carbide Bur **1202305**
- 82T Carbide Bur **1202335**
- 63B Carbide Bur **1202320**
- 53A Carbide Bur **1202325**
- 52C Carbide Bur **1202330**
- 51A Carbide Bur **1202340**
- 61A/81A Carbide Bur **1202315**
- 88A Carbide Bur **1202300**
- 41P Carbide Bur **1202355**
- 44C Carbide Bur **1202360**

*Note: Not all Carbide Burs are available for Canadian shipment. Contact customer service.*

## Diamond Burs - Wheel Shaped

10/pkg.

- Med., Round Wheel - 4.0 Dia. **314068524040**
- Coarse, Round Wheel - 4.0 Dia. **314068534040**
- Med., Wheel Shaped - 4.0 Dia. **314041524040**
- Med., Wheel Shaped - 4.0 Dia. **314042524040**

*Note: Not all Diamond Burs are available for Canadian shipment. Contact customer service.*

## Diamond Burs - Interproximal

10/pkg.

- Fine, Interproximal, 1.6 Dia. **314465514016**



- Gold Colored
- Titanium Nitride Coating
- Low Speed Carbide Burs
- Faster Cutting
- Longer Lasting

## G&H® Instruments

### Diamond Burs - Needle Shaped

10/pkg.

Medium, Short Needle, 1.2 Dia.	<b>314165524012</b>
Medium, Short Needle, 1.4 Dia.	<b>314165524014</b>
Medium, Short Needle, 1.6 Dia.	<b>314165524016</b>
Coarse, Short Needle, 1.2 Dia.	<b>314165534012</b>
Coarse, Short Needle, 1.4 Dia.	<b>314165534014</b>
Coarse, Short Needle, 1.6 Dia.	<b>314165534016</b>
Fine, Med. Needle, 1.0 Dia.	<b>314166514010</b>
Fine, Med. Needle, 1.2 Dia.	<b>314166514012</b>
Fine, Med. Needle, 1.6 Dia.	<b>314166514016</b>
Medium, Med. Needle, 1.2 Dia.	<b>314166524012</b>
Medium, Med. Needle, 1.4 Dia.	<b>314166524014</b>
Medium, Med. Needle, 1.6 Dia.	<b>314166524016</b>
Coarse, Med. Needle, 1.4 Dia.	<b>314166534014</b>
Coarse, Med. Needle, 1.6 Dia.	<b>314166534016</b>
Coarse, Med. Needle, 1.8 Dia.	<b>314166534018</b>
Fine, Long Needle, 1.2 Dia.	<b>314167514012</b>
Fine, Long Needle, 1.4 Dia.	<b>314167514014</b>
Medium, Long Needle, 1.4 Dia.	<b>314167524014</b>
Medium, Long Needle, 1.6 Dia.	<b>314167524016</b>

*Note: Not all Diamond Burs are available for Canadian shipment. Contact customer service.*

### Diamond Burs - Football Shaped

10/pkg.

Fine, Football-Shaped, 1.4 Dia.	<b>314257514014</b>
Fine, Football-Shaped, 1.6 Dia.	<b>314257514016</b>
Medium, Football-Shaped, 1.6 Dia.	<b>314257524016</b>
Medium, Football-Shaped, 1.8 Dia.	<b>314257524018</b>
Coarse, Football-Shaped, 1.8 Dia.	<b>314257534018</b>
Coarse, Football-Shaped, 2.3 Dia.	<b>314257534023</b>

*Note: Not all Diamond Burs are available for Canadian shipment. Contact customer service.*

### Diamond Burs - Flame Shaped

10/pkg.

Medium, Flame-Shaped, 1.4 Dia.	<b>314243524014</b>
Medium, Flame-Shaped, 1.6 Dia.	<b>314243524016</b>
Medium, Flame-Shaped, 1.8 Dia.	<b>314243524018</b>

*Note: Not all Diamond Burs are available for Canadian shipment. Contact customer service.*

### Diamond Burs - Round Shaped

10/pkg.

Fine, Round-Shaped, 1.8 Dia.	<b>314001514018</b>
Fine, Round-Shaped, 2.1 Dia.	<b>314001514021</b>

*Note: Not all Diamond Burs are available for Canadian shipment. Contact customer service.*

Anterior

### ARS Diamond Bur

Use for rapid enamel reduction

5/pkg. **55000**

Posterior

### ARS Cross-Cut Carbide Stripping Bur

Use for rapid enamel reduction

5/pkg. **699LC**



Diamond

### Discs & Cutters

Great for enamel reduction, shaping and interproximal stripping.

**Ultra Flex Cutter** - Ea.

.17mm **1290690**  
.20mm **1290700**



**Mini Flex Cutter** - Ea.

.10mm **1290695**



**Kool Flex Cutter**

Ea. **1290710**  
.17mm



**Flex Edge** (Abrasives Both Sides)

Ea. **DISCDSM**  
(Disc comes with mandrel)



**SuperFlex Edge** (Abrasives Both Sides)

Ea. **910S-220**



**Flex Edge** (Abrasive Up)

Ea. **DISCSSUM**  
(Disc comes with mandrel)



**SuperFlex Edge** (Abrasive Up)

Ea. **912S-220**



**Flex Edge** (Abrasive Down)

Ea. **DISCSSDM**  
(Disc comes with mandrel)



# G&H® Instruments

**SuperFlex Edge** (Abrasive Down)  
Ea. **913S-220**



**Flex Full** (Abrasive Up)  
Ea. **916F-220**



**SuperFlex Full** (Abrasive Up)  
Ea. **916S-220**



**Flex Full** (Abrasive Down)  
Ea. **917F-220**



**SuperFlex Full** (Abrasive Down)  
Ea. **917S-220**



**Flex Full** (Abrasive Both Sides)  
Ea. **927F-220**



**SuperFlex Full** (Abrasive Both Sides)  
Ea. **927S-220**



**Econo Cutter** - Ea.  
2 1/2" **1300480**  
4" **1300500**

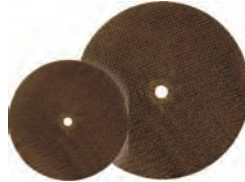

**Wheel Saw** - Ea.  
Raintree **18320**  
Proform **9630100**



Diamond Disc  
**Safety Guard**

Ea. **DISCGD**



Diamond Disc  
**Mandrels**

5/pkg. **DISCMAN**



Scotch-Brite®  
**Polishing Brushes**

Ideal for polishing edges of plastic appliances.

12/pkg.

Fine **1670091**  
Medium **1670092**  
Coarse **1670016**



**Proudly serving the orthodontic  
community for over 40 years!**

*From our quality manufactured products to our dedicated employees, it is our mission to provide our customers a great experience achieved through quality manufacturing and exceptional service.*



## G&H® Impression Supplies

Size 1



Size 2



Size 3



Size 4



Size 5



Lower trays correspond to the uppers in size and color.

Colors may vary slightly from illustration.

Size 6



### G&H® Disposable Impression Trays

G&H® trays are rigid, color-coded anatomical plastic trays with perforation strips that offer economical use and disposability. Long handles provide sure grip while retention slots secure alginate without need for adhesives. They are available in size 1 (smallest) through size 6 (largest); size is imprinted on handle.

#### Box of 25/single color, upper or lower

	Size	Color	Upper	Lower
Smallest	1	Red	<b>DITU0125</b>	<b>DITL0125</b>
	2	Orange	<b>DITU0225</b>	<b>DITL0225</b>
	3	Blue	<b>DITU0325</b>	<b>DITL0325</b>
	4	Green	<b>DITU0425</b>	<b>DITL0425</b>
	5	Yellow	<b>DITU0525</b>	<b>DITL0525</b>
Largest	6	Purple	<b>DITU0625</b>	<b>DITL0625</b>

#### Box of 50/single color, upper or lower

	Size	Color	Upper	Lower
Smallest	1	Red	<b>DITU01</b>	<b>DITL01</b>
	2	Orange	<b>DITU02</b>	<b>DITL02</b>
	3	Blue	<b>DITU03</b>	<b>DITL03</b>
	4	Green	<b>DITU04</b>	<b>DITL04</b>
	5	Yellow	<b>DITU05</b>	<b>DITL05</b>
Largest	6	Purple	<b>DITU06</b>	<b>DITL06</b>

# G&H® Impression Trays & Supplies

## Disposable Impression Trays

Trial pack. (6) sizes - (5)  
trays of each size upper and lower  
Box of 60 **DITAS**



## Disposable - Footed Impression Trays

Box of 50/single color, upper or lower

Size	Color	Upper	Lower
Pedo	Orange	<b>GIT-U4</b>	<b>GIT-L4</b>
Small	Blue	<b>GIT-U3</b>	<b>GIT-L3</b>
Med.	Green	<b>GIT-U2</b>	<b>GIT-L2</b>
Large	Yellow	<b>GIT-U1</b>	<b>GIT-L1</b>



## Stainless Steel Impression Trays

**G&H® Edge-Lok™ Impression Trays** are designed to create consistently accurate and distortion free impressions. They are manufactured from highly polished stainless steel and feature a rolled edge for positive retention of alginate. Edge-Lok™ trays are designed with wide, easy-to-grip handles and come in a range of sizes. They are compatible with ultrasonic, autoclave and dry heat sterilization methods.

Ea.

### Perforated

Size	Upper	Lower
Extra Small	<b>TRAYXSU</b>	<b>TRAYXSL</b>
Small	<b>TRAYSU</b>	<b>TRAYSL</b>
Medium	<b>TRAYMU</b>	<b>TRAYML</b>
Large	<b>TRAYLU</b>	<b>TRAYLL</b>
Extra Large	<b>TRAYXLU</b>	<b>TRAYXLL</b>



Non-perforated



Perforated

### Non-Perforated

Size	Upper	Lower
Extra Small	<b>TRAYXSUNP</b>	<b>TRAYXSLNP</b>
Small	<b>TRAYSUNP</b>	<b>TRAYSLNP</b>
Medium	<b>TRAYMUNP</b>	<b>TRAYMLNP</b>
Large	<b>TRAYLUNP</b>	<b>TRAYLLNP</b>
Extra Large	<b>TRAYXLUNP</b>	<b>TRAYXLLNP</b>

## Utility Wax Strips

These wax strips are excellent for peripheral lining impression trays. 3/16" x 11", white.

75/box **UWX1164**  
450/box **700-117**



## Kromopan® Alginate

**KromoPan®** has chromatic (color) indicators that tell you how long to spatulate (purple), when to load (pink) and when to insert into the patient's mouth (white). Total elapsed time from start to finish is just over 1 minute. Impression can be kept over 100 hours without distortion or shrinkage by simply rinsing and enclosing in a plastic bag.

1lb. bag

**KRM302**



Flavors can be added to improve patient acceptance.

See next page for our flavors!



## Extra-Fast Set OrthoPrint® Alginate

Fast water absorption, highly elastic alginate, easy mixing and homogenous mass, smooth, compact surfaces. Long impression storage at 5 year shelf life. 12 Pouches/Case.

500g Pouch

**C302145**



## Chromatic Alginmax® Alginate

Chromatic indication of the working phases for easy and precise results, regardless of water temperature and hardness. Dust-free powder for safe working and cleaning ease. 44 Pouches/Case

1lb. Pouch

**2802/1**



## Alginate Spatulas

Ea.

Blue	<b>905SA-2C</b>
Yellow	<b>905SA-3C</b>
Green	<b>905SA-4C</b>
Red	<b>905SA-5C</b>
Pink	<b>905SA-6C</b>
Purple	<b>905SA-10C</b>
Orange	<b>905SA-12C</b>



## G&H® Impression Supplies

### Sultan® Healthcare Silgimix™ Alginate

1-380ml cartridge, 10 dynamic mixing tips and 1 bayonet ring.

Mint flavored. (2:10) **79010**



### Sultan® Healthcare Silgimix™ Alginate

50ml, 1:1 cartridges, 8-pack.

Mint flavored. (2:10) **79020**



### Alginate Flavoring

**Alginate Flavors** make taking an impression more pleasant for the patient. Many patient pleasing flavors to choose from! 2 oz. bottles.

Ea.

Apple  
Banana  
Blueberry  
Bubblegum  
Caramel  
Cherry  
Chocolate  
Cinnamon  
Cola  
Cookie Dough  
Cotton Candy  
Fruit Punch  
Grape  
Lemon  
Orange  
Peppermint  
Piña Colada  
Pineapple  
Raspberry  
Root Beer  
Strawberry  
Watermelon

**ALFLAP**  
**ALFLBN**  
**ALFLBL**  
**ALFLBB**  
**ALFLCA**  
**ALFLCH**  
**ALFLCT**  
**ALFLCN**  
**ALFLCO**  
**ALFLCD**  
**ALFLCC**  
**ALFLFP**  
**ALFLGR**  
**ALFLLM**  
**ALFLOR**  
**ALFLPP**  
**ALFLPC**  
**ALFLPN**  
**ALFLRS**  
**ALFLRB**  
**ALFLST**  
**ALFLWM**

Works Great With  
All Alginates!



### Alginator II Mixer 110v

Makes a smooth, bubble-free mix while eliminating waste and reducing clean up time. Now with a single, speed and improved portability and ergonomics.

Box contents include: White 110v Alginator, 1 Identic Dust-Free Fast Set Alginate (1 lb), 1 Gray Latex Free Alginate Bowl, 1 Clean & Lube Spray (4 oz), 1 Spatula.

Ea. **25227**



### Bowl For Alginator II Mixer

Medium - Gray  
3 5/8" x 5"

**25236**

Large Stone Bowl - Gray  
4 1/2" x 5 5/8"

**25252**



### Spatula For Alginator II Mixer

Ea.

**25234**



### Alghamix II Mixer

Alghamix II allows for the mechanical mixing of alginates, plasters and silicones. 30% reduced mixing time when compared to manual mixing. Ergonomic speed selector and bowl position. Includes bowl & 3 year warranty.

Ea.

**C303215**



### Bowl For Alghamix Mixer - Gray

Ea.

**XR-025-0606**

Sultan® Healthcare

### Genie® Impression Material

Ultra Hydrophilic Impression Material

#### Extra-Light Body

2-pack Berry Flavored, 2 x 50mL Cartridges, 6 x 4.2mm Mixing Tips, 6 x Intraoral Tips.

Rapid Set (2:10) Ea. **77600**

Standard Set (4:30) Ea. **77605**

#### Light Body

2-pack Berry Flavored, 2 x 50ml Cartridges, 6 x 4.2mm Mixing Tips, 6 x Intraoral Tips.

Rapid Set (2:10) Ea. **77610**

Standard Set (4:30) Ea. **77615**

#### Regular Body

2-pack Berry Flavored, 2 x 50ml Cartridges, 6 Mixing Tips.

Rapid Set (2:10) Ea. **77620**

Standard Set (4:30) Ea. **77625**

#### Heavy Body

2-pack Berry Flavored, 2 x 50ml Cartridges, 6 x 6.5mm Mixing Tips.

Rapid Set (2:10) Ea. **77630**

Standard Set (4:30) Ea. **77635**



# G&H® Impression Supplies

## Sultan® Healthcare Genie® Putty

Berry flavored.  
2 x 300mL jars and 2 scoops.

Rapid Set (2:30) **77650**  
Standard Set (4:30) **77655**



## Sultan® Healthcare Genie® Bite Registration

Mint flavored.  
2 x 50ml cartridges, 6 mixing tips.

Fast Set (0:90) **77640**  
Super Fast Set (0:60) **77645**



## Sultan® Healthcare Genie® Tray Adhesive

Liquid Polyvinylsiloxane.

14 mL **77100**



## Heraeus Kulzar Flexitime® VPS Imp. Material

**Correct Flow** -  
2 to 1 cartridge - Light Body.  
Includes: (2) 50mL Cartridges,  
(6) Mixing Tips, Users Guide

Ea. **50034806**

Refill Pack: (12) 50mL cartridges,  
(6) Mixing tips  
Ea. **66002186**

**MonoPhase** - Medium Body.  
Includes: (2) 50mL cartridges,  
(6) Mixing tips, Users Guide

Ea. **50034811**

Refill Pack: (12) 50mL cartridges,  
(6) Mixing tips  
Ea. **66002200**

**Dispensing Gun**  
High Performance for VP  
Ea. **VP-8202**



## Heraeus Kulzar Flexitime® Easy Putty

Flexitime® is a vinylpolysiloxane  
impression material that has a full  
range of indications and a working  
time from 1 to 2.5 minutes (total set  
time 3.5 to 5 minutes). 600 mL tub.

Ea. **50034802**



## Heraeus Kulzar Flexitime® Bite

Vinylpolysiloxane bite registration that  
is scannable for use with CAD system.  
Ensures efficiency with a set time of  
only 30 seconds.  
Bulk pack, 50 mL, 6/box.

Ea. **66038751**



## LuxaBite® Bite Registration

LuxaBite is a rigid bisacryl bite  
registration material that combines  
superior handling properties and a  
firmer set to yield the most accurate  
and stable bite registrations on the  
market.

Kit includes: (1) 50 mL, cartridge, 15  
Automix-Tips.

Kit **110560**

Mixing Tips, 25/pkg. **110609**

Dispensing Gun **110411**



# SAVE

## Discover Your Orthodontic Buying Power!

Your membership in the unique G&H®  
OrthoClub® results in big savings.  
Enjoy buying-group savings on more  
than 6,000 brand-name clinical  
supplies plus get special discounts on  
products manufactured by G&H.

*G&H's OrthoClub® –  
Nothing else like it in Orthodontics!*



## G&H® Impression Supplies

Sultan® Healthcare

### Mixing Tips

Use with impression material and bite registration. 48/pkg.

4.2 mm x 12 mm (Yellow) **72003**

6.5 mm x 12 mm (Green) **72001**

#### High performance, intraoral

100/pkg. (Yellow) **72004**



### Buffalo Spatulas/Knives

Flexible stainless steel blade permanently riveted to a hand-rubbed rosewood handle.

Ea.

3 1/2" **11R**

4 1/2" **4R**

1 1/2" Knife **6R**

1 1/2" Knife **7R**



Silicone

### Mixing Bowls

Special surface of silicone rubber is adaptable for orthodontic acrylics, resins and cements. Special shape prevents spillage and aids dispensing of exact amount.

Large - 2/pkg. **5920510**

Med. - 2/pkg. **LGSILDISH**

Small - 3/pkg. **SMSILDISH**



DisposaBowl®

### Disposable Mixing Bowls

The disposable mixing bowls will not crack or break. It is microwavable and great for heating very hot water and for mixing resins. Using the disposable mixing bowl keeps plumbing lines clear and saves chair time.

50/pkg. **DISPOSABOWL**



Spectrum/Flowbowl

### Green Mixing Bowls

Ea.

Amethyst **Medium (350cc)** **Large (600cc)**

Lt. Blue **904MBM-10C** **904MBL-10C**

Green **904MBM-2C** **904MBL-2C**

Red **904MBM-4C** **904MBL-4C**

Yellow **904MBM-5C** **904MBL-5C**

**904MBM-3C** **904MBL-3C**



Flexibowls

### Mixing Bowls

Ea.

Small (150cc) **1150060**

Med. (350cc) **1150070**

Large (600cc) **1150080**

X-Large (850cc) **1150090**



Rubber

### Mixing Bowls

Manufactured from quality black, flexible rubber. 4 1/2" diameter.

Ea. **1150030**



Whip Mix®

### Foilcote

When applied to plaster or stone, it seals the pores and forms a smooth surface that gives excellent separation from the mold. Eliminates the time-consuming tinfoiling and resulting creases.

3.5 oz. **09687**

Gal. **09709**



EZ-Sep

### Separating Medium

8 oz. **RES008**

32 oz. **RES032**



Wonderfill®

### Tongue Filler

Wonderfill requires no setup time and has no messy cleanup. After a lower impression is made, the tongue area is filled with Wonderfill. Plaster/stone is poured and sets, and then Wonderfill is removed for a perfectly clean model.

3.5 lb. **344**



# G&H® Impression Supplies

## Almore® Blue Sheet Wax

Dead soft when heated - Extremely accurate bite registration.  
3" x 6" Sheets

1 lb. **42600**

**Blue Bite Tabs**  
125/Box **42602**



## Bite Wax Sheets

These wax sheets are made of pure beeswax. They are strong, smooth and non-sticky for excellent bite registration. Scored to break apart easily. 3" x 6" x .060"

1 lb. box **BWX021**

5 lb. box **BWX022**

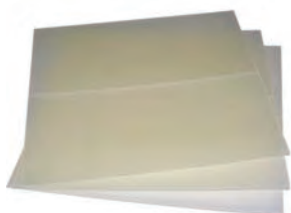

## Aluwax® Impression Wax

50/Box **DF-006**



## Aluwax® Waxed Cloth

Ea. **WCF-005**



## Smoothex® Debubbler

Surface tension reducing liquid.

8 oz. w/Pump **02313**

16 oz. **09849**

34 oz. **29394**



## Russman® Debubbler

8 oz. **RDS8**

32 oz. **RDS32**



## Cadco® Clean & Lube Spray

Used on alginate bowls between mixes for cleaning and reducing bowl abrasion.

4 oz. **23070**



## Cadco® High Spot Moisturizing Spray

Reduces bow abrasion - acts as a debubbler.

4 oz. **27081**



## Clean & Lube Towelettes

Clean and Lube wipes keep alginate bowls flexible and effectively removes alginate and stone residue. 7" x 9" - 25 Towelettes/Tube.

Ea. **23080**



## Alginate Remover

Removes alginate materials from nickel, chrome, steel and plastic impression trays. Two ounces of concentrated powder yields one quart of solution.

2 oz. **240**



## Bosworth Tac™ Tray Adhesive Spray

TAC™ securely holds the alginate in the tray when the impression is removed from the patient's mouth. TAC™ is alcohol-based for faster drying and easier clean-up and can be dissolved with isopropyl alcohol.

3.5 oz. **0921880**



## Tray Cleaner

Removes alginates, modeling compound and wax from metal trays.

454g **951-9194**



## G&H® Impression Supplies

### Cadco® Tray Cleaner

Concentrated granular formulation may be mixed for immediate scrub or as a twenty minute soak for metal impression trays.

400g **24035**



### Coe® Tray Cleaner

Mixes easily with water to remove alginate, wax and material compounds from metal trays and instruments. Cleans in as little as 15 minutes.

575g **250010**



### Non-Irritating Orange Solvent

32 oz. **21002**



### Whip Mix® Stones & Plasters

#### Silky Rock

Violet	25 lb.	<b>01910</b>
Violet	55 lb.	<b>31755</b>
Yellow	25 lb.	<b>01996</b>
Yellow	55 lb.	<b>33162</b>
White	25 lb.	<b>02070</b>
White	55 lb.	<b>27219</b>
Ivory	55 lb.	<b>33163</b>
Violet	80 Pkts.	<b>01953</b>



#### Prima Rock

Violet	25 lb.	<b>16608</b>
Violet	55 lb.	<b>31712</b>
Yellow	25 lb.	<b>16616</b>
Yellow	55 lb.	<b>31720</b>
Ivory	55 lb.	<b>34878</b>

#### Hard Rock

Aqua	55 lb.	<b>26530</b>
Green	55 lb.	<b>32069</b>
Ivory	55 lb.	<b>34002</b>



#### ResinRock

Peach	11 lb.	<b>34916</b>
Peach	55 lb.	<b>34975</b>
Blue	11 lb.	<b>34924</b>
Blue	55 lb.	<b>34967</b>
Gray	11 lb.	<b>34940</b>
Gray	55 lb.	<b>34959</b>
Ivory	11 lb.	<b>34970</b>
Ivory	55 lb.	<b>34971</b>



### Whip Mix® Stones & Plasters Cont.

#### Micro Stone

Gold	25 lb.	<b>02305</b>
Gold	50 lb.	<b>31763</b>
White	25 lb.	<b>02399</b>
White	50 lb.	<b>31771</b>



#### Ortho Stone

Super Wht.	25 lb.	<b>02682</b>
Super Wht.	50 lb.	<b>31801</b>



#### Mounting Stone

White	25 lb.	<b>02917</b>
Blue	25 lb.	<b>18740</b>

#### Jade Stone Die Material

Green	25 lb.	<b>18570</b>
Green	55 lb.	<b>31739</b>
Blue	25 lb.	<b>19291</b>
Blue	55 lb.	<b>31747</b>

#### Snap Stone

Pink	11 lb.	<b>23690</b>
Pink	25 lb.	<b>23698</b>
Pink	80 Pkts.	<b>26514</b>
Pink	50 lb.	<b>33219</b>



#### Lab Plaster - Regular Set

White	20 lb.	<b>02941</b>
White	50 lb.	<b>31828</b>

#### Lab Plaster - Fast Set

White	50 lb.	<b>31577</b>
-------	--------	--------------

#### Ortho Plaster

White	20 lb.	<b>03077</b>
White	50 lb.	<b>31836</b>



#### Mounting Plaster

White	20 lb.	<b>15520</b>
White	50 lb.	<b>33227</b>

### Modern Materials® Stones & Plasters

#### Denstone

White	25 lb.	<b>50046172</b>
White	50 lb.	<b>50046182</b>
Gold	25 lb.	<b>50046175</b>
Gold	50 lb.	<b>50046185</b>
Pink	50 lb.	<b>50046183</b>



#### Lab Stone

Buff	25 lb.	<b>50046277</b>
Buff	50 lb.	<b>50046287</b>
Blue	25 lb.	<b>50046279</b>
Blue	50 lb.	<b>50046289</b>



#### Die Keen Type II

Pink	25 lb.	<b>50046560</b>
Pink	50 lb.	<b>50046590</b>
Blue	25 lb.	<b>50046565</b>
Blue	50 lb.	<b>50046585</b>
Green	25 lb.	<b>50046578</b>
Green	50 lb.	<b>50046580</b>
Ivory	25 lb.	<b>50046615</b>
Ivory	50 lb.	<b>50046635</b>



#### Ortho Stone - Type III

White	25 lb.	<b>50046972</b>
White	50 lb.	<b>50046952</b>

# G&H® Clinical Supplies

Modern Materials®

## Stones & Plasters Cont.

### Ortho Plaster - Type II

Snow Wht. 25 lb. **50048170**

Snow Wht. 50 lb. **50048180**

### Lab Plaster - Regular Set

White 25 lb. **50048472**

White 50 lb. **50048452**

### Lab Plaster - Fast Set

White 25 lb. **50048512**

White 50 lb. **50048552**

### Lab Plaster - Slow Set

White 50 lb. **50048652**



Non-Yellowing

## Model Glow Soap

Model glow gives an incredibly high luster to gypsum models. Its special formulation does not yellow or flake and seals the pores to provide a protective coating.

Gal. **29009**



Orthodontic

## Model Storage Boxes

Heavy-duty, water resistant, compactly designed, very easy to assemble, with ample cell space. Each drawer holds 20 models.

Dimensions: 15.5" x 15.5" x 18"

4 Set/Drawers **OD004**

4 Set/Top Load **OB004**



Orthodontic

## Model Storage Boxes

Dimensions: 11.25" x 3.75" x 2.75"  
Comes with 4 or 6 pocket divider.

100/Box **610-070**

25/Box **610-071**

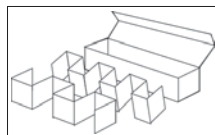

DeLar

## Split-Cast Large Formers

Includes surfactant and separating medium.

Kit **SCL020**



## Acetate Tracing Paper

Cephalometric and panoramic, matte-finish .003" acetate tracing paper offers excellent pencil adhesion and dimensional stability. The non-curling edges maintain flatness. A matte side accepts pencil or pen markings with excellent contrast clarity. (8" x 10" Tablet (100 sheets)

Ea. **ATP100810G**



## Archwire Marking Pencils

Made with high quality beeswax tip on disposable stick which ensures mark will stay in place. It is not water soluble like crayon-based markers.

100/pkg.

Red-tip Pencils **AMP020**

White-tip Pencils **AMP020W**



## Pop-Up Dispenser

Push-button action dispenses one pencil on demand.

Ea. **AMD010**

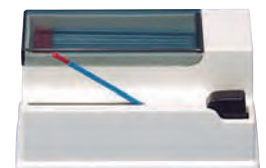

(Actual product style may vary from image)



## G&H® Clinical Supplies

### Photographic Mirrors - Glass

**G&H® Premium Glass Photographic Mirrors** offer unsurpassed quality and the finest possible color and image transfer. Manufactured of 3mm float glass for distortion-free surface and double-sided coated with chromium for maximum reflective qualities. G&H® mirrors are the finest of their kind. They are compatible with autoclave sterilization. See full-size mirror illustrations on following page.

- Ea.
- |                      |               |
|----------------------|---------------|
| Extra-Large Occlusal | <b>PRMRXL</b> |
| Adult Occlusal       | <b>PRMRAD</b> |
| Child Occlusal       | <b>PRMRCH</b> |
| Lingual              | <b>PRMRLG</b> |
| Buccal               | <b>PRMRBC</b> |
- Set of (4)**  
Includes all but PRMRXL
- PRMRKT4**

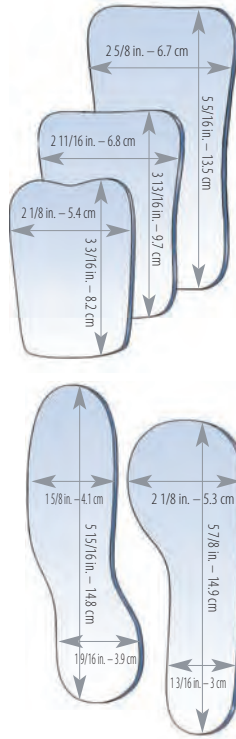

### Angled Occlusal Mirror

**G&H® Angled Occlusal Stainless Steel Photographic Mirrors** is double-ended to accommodate both small and large patients. The mirror is angled approximately 15° to allow patient or operator to hold and keep hand out of camera view. Polished on both sides.



Ea. **SSMROCANG**

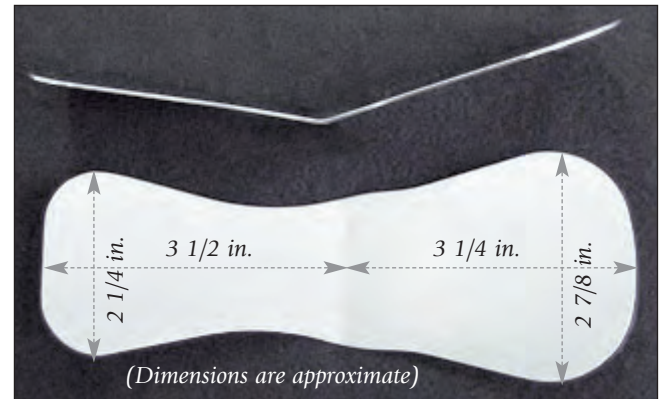

### Photographic Mirrors - Stainless Steel

**G&H® Stainless Steel Photographic Mirrors** offer the ultimate in durability. Highly polished stainless steel surfaces cannot chip, crack or peel. Double-sided for maximum life, the mirrors have polished, rounded edges for patient comfort and are compatible with autoclave sterilization. Note: sizes and shapes vary slightly from illustrations on following page.

- Ea.
- |          |               |
|----------|---------------|
| Occlusal | <b>SSMROC</b> |
| Buccal   | <b>SSMRBC</b> |
| Lingual  | <b>SSMRLG</b> |
- Set of (3)**  
Includes (1) of each
- SSMRKT3**



#### Cleaning and Sterilization Recommendations for Photographic Mirrors

- Gently wash mirrors with mild hand soap using alcohol to remove greasy substances such as lipstick.
- Dry the mirror with a soft cloth lightly then air dry until all moisture has evaporated.
- Any spots left on mirror will not come off after heat or autoclave sterilization. If the mirror can not be cleaned right away keep it wet or covered with a wet towel.
- Never place a mirror into an ultrasonic unit.
- Keep the mirror out of contact with all other instruments. Wrap the mirror into a microfiber cloth or paper towel and place it in the sterilizing pouch. The wrapping will absorb any steam that builds up on the mirror inside the pouch.
- Follow the sterilization recommendations as provided by the manufacturer of your sterilizer.



## EXCLUSIVE MEMBER BENEFITS

- ▶ The power of wholesale buying volume discounts on our entire line - over 6,000 items
- ▶ Special member-only promotional savings
- ▶ The quantities you need when you need them—no need to carry excessive inventory
- ▶ No minimum purchase required
- ▶ \$400 annual membership, is more than covered in annual savings. Like everything at G&H, your satisfaction is guaranteed!
- ▶ **Exclusive offers**
- ▶ **New member Bonus Pack - \$100 of FREE product samples**

**SIGN UP**  
**TODAY!**

Join today at:

**GHOrthoClub.com**  
or call: **888-723-7860**  
and **START SAVING!**

**The Club that pays you back in savings!**

**GHOrthodontics.com • Toll-Free 888-723-7860 • orders@ghortho.com**

\*Membership fee credited if not fully satisfied within the first 6 months.

## G&H® Clinical Supplies

### Universal Photographic Mirror Handle

**SureGrip™** universal photographic mirror handle is clinically functional and user friendly. Makes taking unobstructed intraoral photographs easy from any angle.

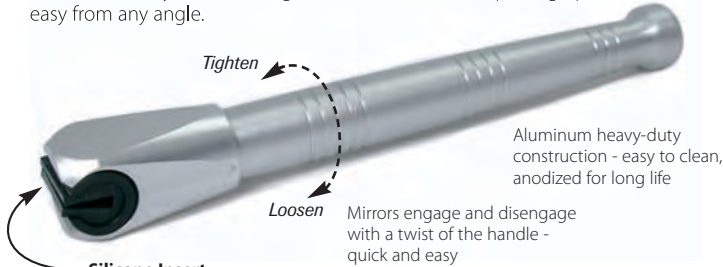

#### Silicone Insert

- Permanently attached to head unit
- Mirror locks positively in handle - will not slip
- Rotates to desired angle
- Fully autoclavable



**Fully adjustable** - mirror can be positioned and held at any angle.

Handle length: 4.5"

Suregrip™ for Premium Glass Mirrors **SGPR**  
 Suregrip™ for Stainless Steel Mirrors **SGSS**

#### Components

Premium Glass Mirror Head Unit **SGPRH**  
 Stainless Steel Mirror Head Unit **SGSSH**  
 Handle Only - (Fits either head) **SGH**



*Cold sterilization and dry heat sterilization not recommended*

### Moyco® Indian Head Mouth Mirrors

Electro-polished, rhodium-coated.  
 12/Box

- |                |                  |
|----------------|------------------|
| #3 Simple Stem | <b>011-24677</b> |
| #4 Simple Stem | <b>011-24678</b> |
| #5 Simple Stem | <b>011-24679</b> |
| #6 Simple Stem | <b>011-24680</b> |
| #3 Cone Socket | <b>011-24692</b> |
| #4 Cone Socket | <b>011-24693</b> |
| #5 Cone Socket | <b>011-24694</b> |
| #6 Cone Socket | <b>011-24695</b> |



### Mirror Head

Metal-coated.

12/Box

- |                |                  |
|----------------|------------------|
| #3 Cone Socket | <b>QM500-CS3</b> |
| #4 Cone Socket | <b>QM500-CS4</b> |
| #5 Cone Socket | <b>QM500-CS5</b> |
| #3 Simple Stem | <b>QM530-SS3</b> |
| #4 Simple Stem | <b>QM530-SS4</b> |
| #5 Simple Stem | <b>QM530-SS5</b> |



### Mirror Handle

Ea.

- |                                 |               |
|---------------------------------|---------------|
| <b>5" Handle - Simple Stem.</b> |               |
| Octagonal                       | <b>07-400</b> |
| Round                           | <b>07-410</b> |
| <b>5" Handle - Cone Socket</b>  |               |
| Octagonal                       | <b>07-405</b> |
| Round                           | <b>07-420</b> |



### Disposable Mouth Mirror

100/pkg.

**MMR-1**



### Disposable Mouth Mirror

48/pkg.

**200MMR-A**

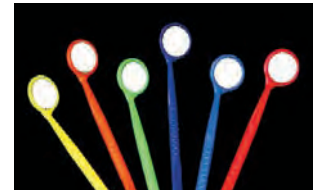

# G&H® Clinical Supplies

## Defend® Plastic Cups

5 oz. - 1,000/Box

White	<b>DC-7000</b>
Blue	<b>DC-7001</b>
Mauve	<b>DC-7002</b>
Green	<b>DC-7003</b>
Lavender	<b>DC-7004</b>



## Tidi® Plastic Cups

5 oz. - 1,000/Box

Lavender	<b>9210</b>
White	<b>9211</b>
Green	<b>9212</b>
Blue	<b>9213</b>
Yellow	<b>9214</b>
Gray	<b>9215</b>
Mauve	<b>9216</b>
Peach	<b>9218</b>



3.5 oz. - 1,000/Box

White	<b>9241</b>
Blue	<b>9243</b>



## Cup Holder

Ea. **1202P**

## Crosstex® Cup Holder

Ea. **PCC**



## Bausch Articulating Paper

200 microns, 300 strips in a plastic dispenser.

Ea. **BK-01**



## Bausch Occlusionspapier

Micro-thin 40 microns, 200 strips.

Ea. **BK-09**



## Accufilm I Occlusal Marking Film

280 strips.

Single Sided, Black	<b>S014</b>
Single Sided, Red	<b>S015</b>
Single Sided, Green	<b>S016</b>



## Accufilm II Occlusal Marking Film

Eliminates false occlusal markings. Use dull side for marking. 280 strips.

Double Sided, Red/Black	<b>S017</b>
Double Sided, Black/Black	<b>S018</b>
Double Sided, Red/Red	<b>S021</b>



## Crosstex® Occlusal Marking Film

144 strips.

X-Thin, Blue	<b>TPXT</b>
Thick, Blue	<b>TPTH</b>
Thin, Blue	<b>TPT</b>
Double Sided, Red/Blue	<b>TPBR</b>



## Topical Anesthetic

Contains 20% Benzocaine for maximum pain relief. Bubble gum flavored.

1 oz. **11-31005**



## Topical Anesthetic Spray

20% Benzocaine, delivers fast maximum strength pain relief, ideal for deep scaling and gag relief. Wild cherry flavored - 25 straws.

2 oz. **AD31000**



## Tidi® Disposable Headrest Covers

500/Box

10"x10"	<b>919511</b>
10"x13"	<b>919512</b>
13"x13"	<b>919513</b>



## G&H® Clinical Supplies

### Tidi® Disposable Headrest Covers

500/Box	
10"x10" - White	<b>919611</b>
10"x10" - Clear	<b>919612</b>
13"x10" - White	<b>919621</b>
13"x10" - Clear	<b>919622</b>
13"x13" - White	<b>919631</b>



### Headrest Covers

250/Box	
9½"x11"	<b>PS650</b>
10"x14"	<b>PS660</b>

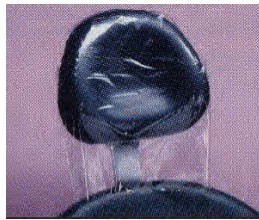

### Chair Covers

225 sleeves per roll - 27.5" x 24"	
Ea.	<b>915001</b>
Full chair cover - 200/Box	
Ea.	<b>PS105</b>
X-long full chair cover - 125/Box	
Ea.	<b>PS3850</b>



### Tray Sleeves

500/pkg.	
10½"x14"	<b>PS201</b>
11½"x16"	<b>PS203</b>



### Tidi® Tray Covers

<b>8½"x12½"</b> - 1,000/pkg.	
White	<b>917511</b>
Green	<b>917512</b>
Blue	<b>917513</b>
Yellow	<b>917514</b>
Mauve	<b>917516</b>
Lavender	<b>917519</b>
<b>9½"x12½"</b> - 1,000/pkg.	
White	<b>917521</b>
Blue	<b>917523</b>
<b>9½"x13½"</b> - 1,000/pkg.	
White	<b>917531</b>
<b>10"x17½"</b> - 1,000/pkg.	
White	<b>917541</b>
<b>11"x17¼"</b> - 1,000/pkg.	
White	<b>917551</b>
<b>11"x17¼"</b> - 1,000/pkg.	
Blue	<b>917553</b>
<b>5"x8"</b> - 1,000/pkg.	
White	<b>917571</b>



### Defend® Tray Covers

8 ½"x12 ¼" - 1,000/pkg.

White	<b>TC-9000</b>
Blue	<b>TC-9001</b>
Mauve	<b>TC-9002</b>
Green	<b>TC-9003</b>
Lavender	<b>TC-9004</b>



### Divided Trays

Size (B) 13½" x 9⅝", Ea.

Beige	<b>300BD-7</b>
Light Mauve	<b>300BDS-10PL</b>
Lilac	<b>300BDS-10PS</b>
Tangerine	<b>300BDS-12</b>
Vanilla	<b>300BDS-1PS</b>
Neon Blue	<b>300BDS-2N</b>
Baby Blue	<b>300BDS-2PS</b>
Sea Green	<b>300BDS-4PS</b>



### Operation Tub

Size 11½" x 9⅝" x 2⅝", Ea.

White	<b>500TB-1</b>
Flame	<b>500TB-5</b>
Beige	<b>500TB-7</b>



### Chrome Tray Racks

Ea.

<b>Size (A) - Holds 8 Trays</b>	<b>300TRA</b>
15"W x 9¾"D x 14⅞"H	
<b>Size (B) - Holds 8 Trays</b>	<b>300TRB-C</b>
14½"W x 9¾"D x 14⅞"H	
<b>Size (D) - Holds 8 Trays</b>	<b>300TRD</b>
14½"W x 9¾"D x 14⅞"H	
<b>Size (E) - Holds 8 Trays</b>	<b>300TRE</b>
16¼"W x 9¾"D x 13"H	
<b>Size (F) - Holds 6 Trays</b>	<b>300TRF</b>
10"W x 6¼"D x 13"H	



### Chrome Tub Rack

Holds 4 tubs. 15" x 9¾" x 14⅞"

Ea.	<b>500BRB</b>
-----	---------------



# G&H® Clinical Supplies

## Flat Tray

### Size (A) 10 1/4" x 10 1/2"

Ea.	
White	<b>300AF-1</b>
Light Blue	<b>300AF-2</b>

### Size (B) 13 1/2" x 9 3/4"

Ea.	
White	<b>300BF-1</b>
Mauve	<b>300BF-10</b>
Black	<b>300BF-11</b>
Teal	<b>300BF-14</b>
Light Blue	<b>300BF-2</b>
Light Yellow	<b>300BF-3</b>
Green	<b>300BF-4</b>
Flame	<b>300BF-5</b>
Coral	<b>300BF-6</b>
Beige	<b>300BF-7</b>
Light Gray	<b>300BF-9</b>
Neon Purple	<b>300BFS-10N</b>
Light Mauve	<b>300BFS-10PL</b>
Lilac	<b>300BFS-10PS</b>
Tangerine	<b>300BFS-12</b>
Vanilla	<b>300BFS-1PS</b>
Neon Blue	<b>300BFS-2N</b>
Baby Blue	<b>300BFS-2PS</b>
Neon Yellow	<b>300BFS-3N</b>
Neon Green	<b>300BFS-4N</b>
Sea Green	<b>300BFS-4PS</b>
Neon Pink	<b>300BFS-6N</b>
Sand	<b>300BFS-7PS</b>

### Size (D) 13 3/4" x 7 3/4"

Ea.	
White	<b>300DF-1</b>
Light Blue	<b>300DF-2</b>

### Size (E) 15" x 10 1/2"

Ea.	
White	<b>300EF-1</b>
Light Blue	<b>300EF-2</b>

### Size (F) 9 3/4" x 6 3/4" (Mini)

Ea.	
White	<b>300FM-1</b>
Black	<b>300FM-11</b>
Light Yellow	<b>300FM-3</b>
Green	<b>300FM-4</b>
Flame	<b>300FM-5</b>
Beige	<b>300FM-7</b>
Neon Purple	<b>300FMS-10N</b>
Neon Blue	<b>300FMS-2N</b>
Baby Blue	<b>300FMS-2PS</b>
Neon Yellow	<b>300FMS-3N</b>
Neon Green	<b>300FMS-4N</b>
Neon Pink	<b>300FMS-6N</b>
Sand	<b>300FMS-7PS</b>

## Tray Lids

<b>Size (B)</b>	
Ea.	<b>300BB-COVR</b>

<b>Size (F)</b>	
Ea.	<b>300FM-COVR</b>



## Tub and Tray Colors

### STANDARD



### PASTELS

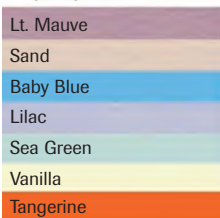

### NEONS



Tidi®

## Poly Towel 2-Ply

Poly-backed for dependable patient protection, diamond-embossed for a thicker, absorbent feel. 13"x18".

500/pkg.

Lavender	<b>919459</b>
White	<b>919461</b>
Green	<b>919462</b>
Blue	<b>919463</b>
Yellow	<b>919464</b>
Gray	<b>919465</b>
Mauve	<b>919466</b>
Beige	<b>919467</b>
Peach	<b>919468</b>
Teal	<b>919470</b>



## Patient Bibs 2-Ply

Horizontal embossing allows the moisture to flow horizontally across the towel, protecting the patient's clothing. 13"x18".

500/pkg.

Blue	<b>BIB-2</b>
Green	<b>BIB-4</b>
Lavender	<b>BIB-10L</b>
White	<b>BIB-1</b>
Yellow	<b>BIB-3</b>
Pink	<b>BIB-6</b>
Peach	<b>BIB-12P</b>



## Bib Holders

Front Load.

Ea.	<b>1205B</b>
-----	--------------



## Contour Mask Holder

Molded cone face mask organizer. 6 1/2" x 7 1/4" x 5 5/8".

Ea.	<b>1211</b>
-----	-------------

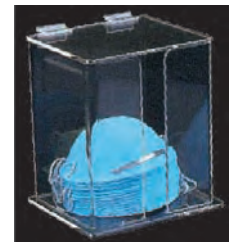

## Ear-Loop Mask Holder

Ear-loop face mask organizer. 8 1/2" x 5 1/4" x 5".

Ea.	<b>1212</b>
-----	-------------

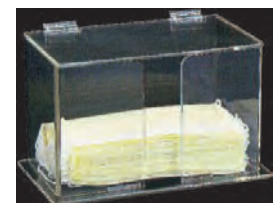

## G&H® Clinical Supplies

### Harmony® Ear-Loop Face Mask

Latex-free. Blue. 10 boxes/case  
50/Box **FEL220B**



### Adenna® Ear-Loop Face Mask

Fiberglass-free & latex-free. 10 boxes/case  
50/Box  
Blue **FEL110B**  
Pink **FEL110P**  
Violet **FEL110V**  
White **FEL110W**



### Crosstex® Ear-Loop Face Mask

Fiberglass-free & latex-free.  
Blue. 10 boxes/case  
50/Box **GCABL**



### Crosstex® Isofluid® Ear-Loop Face Mask

Fiberglass-free & latex-free.  
Lavender. 10 boxes/case  
50/Box **GCILV**



### Defend® Molded Cone Face Mask

50/Box, 10 boxes/case  
Ea./Box  
Blue **MK-1007**  
Pink - 10% smaller than blue **MK-1008**



### Defend® Ear-Loop Face Mask

100/Box, 10 boxes/case  
Ea./Box  
Blue **MK-2000**  
Pink - 10% smaller than blue **MK-2001**



### Proof™ Tie-On Face Mask

Fluid proof. 10 boxes/case  
50/Box **7003**



### Ultra 3-in-1 Fog Free Ear-Loop Face Mask

Inner and outer fog-free strips eliminate fogging up of eyeglasses. Along with being ultra breathable, they have ultra high filtration.

50/Box  
Blue **950-8040**  
Multi-Colored **950-8042**  
Peach **950-8044**



### Adenna® Gold Powder-Free Latex Gloves

100/Box (90/Box for XL), 10 boxes/case  
Ea./Box  
X-Small **GLD260**  
Small **GLD262**  
Medium **GLD265**  
Large **GLD266**  
X-Large **GLD268**



### Adenna® Bronze Powder-Free Latex Gloves

100/Box (90/Box for XL), 10 boxes/case  
Ea./Box  
X-Small **BRZ640**  
Small **BRZ642**  
Medium **BRZ645**  
Large **BRZ646**  
X-Large **BRZ648**



*Note: Adenna Bronze Latex Gloves are not available for Canadian shipment.*

### Adenna® Miracle® Powder-Free Nitrile Gloves

**200/Box (180/Box for XL),**  
10 boxes/case  
Ea./Box  
X-Small **MIR160**  
Small **MIR162**  
Medium **MIR165**  
Large **MIR166**  
X-Large **MIR168**



### Adenna® Powder-Free Nitrile Gloves

100/Box (90/Box for XL), 10 boxes/case  
Ea./Box  
X-Small **NPF880**  
Small **NPF882**  
Medium **NPF885**  
Large **NPF886**  
X-Large **NPF888**



# G&H® Clinical Supplies

## Adenna® Precision® Powder-Free Nitrile Gloves

100/Box (90/Box for XL), 10 boxes/case  
Ea./Box

X-Small	<b>PCS770</b>
Small	<b>PCS772</b>
Medium	<b>PCS775</b>
Large	<b>PCS776</b>
X-Large	<b>PCS778</b>



## Adenna® Night Angel® Powder-Free Black Nitrile Gloves

100/Box (90/Box for XL), 10 boxes/case  
Ea./Box

X-Small	<b>NGL220</b>
Small	<b>NGL222</b>
Medium	<b>NGL225</b>
Large	<b>NGL226</b>
X-Large	<b>NGL228</b>



## Adenna® Powder-Free Vinyl Gloves

100/Box (90/Box for XL), 10 boxes/case  
Ea./Box

X-Small	<b>VPF230</b>
Small	<b>VPF232</b>
Medium	<b>VPF235</b>
Large	<b>VPF236</b>
X-Large	<b>VPF238</b>



## Latex Finger Cots

144/Box

Small	<b>342-0690</b>
Medium	<b>342-0700</b>
Large	<b>342-0701</b>
X-Large	<b>342-0702</b>



## Glove Rack

Fits one standard size glove box horizontally or two boxes vertically. Mounts easily onto wall with included hardware.

Ea. **BHW501**



## Acrylic Glove Dispenser

#1400H: Fits one standard size glove box horizontally. Mounts easily onto wall. Dimensions are 10"W x 5 3/4"H x 3 1/8"D.  
#1400: Fits one standard size glove box vertically. Mounts easily onto wall. Dimensions are 5 3/4"W x 10"H x 3 1/8"D.

Horizontal Ea.	<b>1400H</b>
Vertical Ea.	<b>1400</b>



## Lead-Free By Dux® X-Ray Apron

23" width x 26" length measured from neckline. Blue microfiber.

Ea.	
With Collar	<b>31459</b>
Without Collar	<b>31458</b>



## Lead-Free By Dux® Panoramic Poncho

From the center of the neck: front 19" length, back 30" length and shoulder 23" width.

Ea.	<b>31460</b>
-----	--------------



## X-Ray Aprons

Ea.	
<b>Adult Apron</b>	
Beige	<b>20BEIGE</b>
Blue	<b>20BLUE</b>
<b>Adult Dual Apron</b>	
Beige	<b>26BEIGE</b>
Blue	<b>26BLUE</b>
<b>Child Dual Apron</b>	
Blue	<b>26CBBLUE</b>
<b>Child Apron</b>	
18" x 24" .3mm - Gray	<b>22GREY</b>
18" x 24" .3mm - Blue	<b>22BLUE</b>



**Lead Apron Hanger**  
Heavy duty steel, painted in white baked enamel. Mounting hardware included. 15"x2".

Ea.	<b>28</b>
-----	-----------



**Apron Hanger**  
Chrome plated, 3/16" steel hanger recommended to protect garments and increase product life. Will hold up to 50 lbs. (22.7 kg) and will not stress the lead vinyl or outer covering.

Ea.	<b>33</b>
-----	-----------

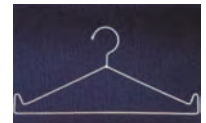

<b>Neck Collars</b>	
Adult - Slate Blue	<b>25SLATEBLUE</b>
Child - Slate Blue	<b>25CSLATEBLUE</b>
Adult - Blue	<b>25BLUE</b>
Adult - Gray	<b>25GRAY</b>
Adult - Beige	<b>25BEIGE</b>



## Kodak® Manual Processing GBX

Twin Pack	
28 oz. Dev. & Fixer	<b>190-1859</b>
Fixer	
28 oz.	<b>190-1875</b>
Developer	
28 oz.	<b>190-0943</b>





## G&H® Clinical Supplies

### Kodak® Automatic Processing Readymatic Chem Pack

2 Gal. Developer, 2 Gal. Fixer  
Ea. **102-8869**



### Kodak® Automatic Processing Readymatic Fixer

4 Gal./Case  
Gal. **871-2879**



### Kodak® Automatic Processing Readymatic Developer

4 Gal./Case  
Gal. **877-7534**



### Kodak® Ceph Film

50/Box  
TMH-1, 8x10 **141-3905**  
TML-1, 8x10 **158-9852**  
XDBF-1, 8x10 **802-1933**  
TMG-1, 8x10 **845-3938**



### Kodak® Ultra Speed Periapical Film

DF-56 #1 - 100/Box **127-3747**



### Kodak® Pan Film

50/Box  
TMH-15, 15x30 **106-7529**  
EVG-5, 5x12 **147-7405**  
TMH-5, 5x12 **176-3044**  
TMG-5, 5x12 **198-7627**  
DF-76, 15x13 **199-0712**  
EVG-15, 6x12 **837-2716**  
DF-75, 5x12 **871-3471**



### Kodak® Occlusal Film

25/Box  
DF-50 #4 **166-6163**



### Kodak® Duplicating Film

50/Box  
5x12 **121-5821**  
15x30 **149-3691**  
8x10 **175-3185**



### Fuji® Ceph Film

100/Box  
Super HR-U, Med. Speed,  
Green, 8x10 **HRU5080**  
RX Blue, 8x10 **PPB5080**  
Super HR-T, Med. Speed,  
Green, 8x10 **PHG5080**

### Fuji® Pan Film

100/Box  
Super HR-U, medium speed, green,  
high contrast orthochromatic film for  
use with green emitting rare earth  
screens  
Super HR-U, Med. Speed, **HRU5050**  
Green, 15x30  
Super HR-U, Med. Speed, **HRU5052**  
Green, 5x12

Super RX Blue, high speed, high  
contrast, blue sensitive film for use  
with blue emitting screens  
Super RX, Blue, 15x30 **PPB5050**  
Super RX, Blue, 5x12 **PPB5052**

Super HR-T, medium speed, green,  
high resolution, high contrast,  
orthochromatic film for use with green  
emitting rare earth screens

Super HR-T, Med. Speed, **PHG5050**  
Green, 6x12  
Super HR-T, Med. Speed, **PHG5052**  
Green, 5x12



### Fuji® Duplicating Film

100/Box  
MI-Dup, 5x12 **PDB5052**  
MI-Dup, 8x10 **PDB5080**

### Air Technique Developer

4 Gal./Case  
Gal. **40240**



# G&H® Clinical Supplies

Air Technique

## Fixer

4 Gal./Case

Gal. **40245**



Air Technique

## Chem Pak

2 Gal. Dev., 2 Gal. Fixer.

Ea. **40270**



Air Technique

## Starter Solution

Ea. **40280**

Dent-X

## Chem Pak

2 Gal. Dev., 2 Gal. Fixer **952-2958**



Dent-X

## Developer & Fixer

Excel Fixer, Gal. **952-2964**

Excel Developer, Gal. **952-2962**

Air Technique

## Formula 2000 Cleanser Twin Pack

This powerful, effervescent two-part cleaner dissolves deposits in minutes. For transport processors, rollers & dip tanks. Twin pack.

Ea. **43945**



Air Technique

## Spray 2000 Transport Cleaner

Regular maintenance of your Roller Transport Film Processor with Spray 2000™ Plus ensures the best quality radiographs and longest service life. 1 Liter (33.8 oz) spray, 1 sprayer top and 4 cleaning webs.

Ea. **43965**



Kodak®

## Roller Transport Clean Up Film

8x10 **103-9205**



Clear Image®

## Processor Cleaner

Gal. **CI-128-4**

Qt. - w/Pump **CI-32-12**



Sharp Image®

## Roller Transport Clean Up Sheets

Daily cleaning sheets.

50/pkg. **CI0810**



Dent-X® Easy Clean

## Processor Transport Cleaner

This environmentally safe cleaner is a water-soluble powder. Simply drop your racks, rollers or tanks into the solution and leave them overnight or over the weekend.

Ea. **9992602600**



Dent-X®

## Film Processor 810 Basic

Proven reliability and durability for over 25 years.

Ea. **810BASIC**



Dent-X®

## Film Processor 810 Plus

The same specifications as 810 Plus-AR, but without built-in chemical replenishment.

Ea. **810PLUS**



Dent-X®

## Film Processor 810 Plus A/R

Fully automatic with built-in chemical replenishment. Processing parameters controlled automatically.

Ea. **810PLUS/AR**



# Office & Patient Supplies



G&H® supplies a complete line of disposables & consumables and patient support items.

# G&H® For the Patient

## Retainer Cases

These are the finest retainer cases specially designed for G&H® to be patient friendly & functional.



*Secure locking mechanism keeps the case closed while a one-handed, easy-open release is featured. Varieties of colors give patients a wide choice.*



Dimensions:  
1" deep,  
3¼" wide,  
2½" front to back

- Unique Design
- One-Piece Vented Construction
- One-Handed Easy Release

### Patient Friendly Design

- Easy-Open – One-hand release
- Sleek Design – Goes anywhere
- 15 Different Colors, – Patient choice
- Vented Air Holes – Retainers stay fresh

### Quality Construction

- Heavy Gauge Plastic – Durable
- One-Piece Construction – Sturdy & Unbreakable
- Everlasting Hinge Design – Long Life
- Stays Closed – Positive Lock-Tight Latch
- Right Size – Big enough for appliance, small enough to fit in pocket or purse

### Order Options

- Wide Selection – 15 colors
- Single-Color Packs – Any color
- 50 Cases to a Pack – Single or Multi-color



### Multi-Color Pack (15 colors)

50/pkg.

**RETAS**

### Single Color Pack

50/pkg.

Black	<b>RETBK</b>	Purple	<b>RETPP</b>
Pink	<b>RETPK</b>	Red	<b>RETRD</b>
Blue	<b>RETBK</b>	Turquoise	<b>RETTQ</b>
Royal Blue	<b>RETRB</b>	Yellow	<b>RETYE</b>
Silver	<b>RETSV</b>	Fl. Yellow	<b>RETYW</b>
Green	<b>RETGN</b>	Clear	<b>RETCL</b>
Dk. Green	<b>RETGR</b>	White	<b>RETWH</b>
Orange	<b>RETOR</b>		



Deluxe

## Retainer Cases

1¾" Depth.  
25/pkg.

Assorted	<b>700-020</b>
Aqua	<b>700-019</b>
Black	<b>700-017</b>
Blue	<b>700-013</b>
Clear	<b>700-016</b>
Glow	<b>700-023</b>
Green	<b>700-014</b>
Neon Pink	<b>700-010</b>
Orange	<b>700-011</b>
Purple	<b>700-018</b>
Red	<b>700-012</b>
Yellow	<b>700-015</b>



Ultra-Guard

## Mouth Guards

10/pkg.

	W/Strap	W/O Strap
Assorted	<b>58000D</b>	<b>58100D</b>
Red	<b>58001D</b>	<b>58101D</b>
Green	<b>58002D</b>	<b>58102D</b>
Yellow	<b>58003D</b>	<b>58103D</b>
Blue	<b>58004D</b>	<b>58104D</b>
Black	<b>58005D</b>	<b>58105D</b>
Clear	<b>58006D</b>	<b>58106D</b>



12/pkg. Individually wrapped

	W/Strap	W/O Strap
Assorted	<b>24000</b>	<b>24100</b>
Red	<b>24001</b>	<b>24101</b>
Green	<b>24002</b>	<b>24102</b>
Yellow	<b>24003</b>	<b>24103</b>
Blue	<b>24004</b>	<b>24104</b>
Black	<b>24005</b>	<b>24105</b>
Clear	<b>24006</b>	<b>24106</b>



With Strap

## Mouth Guards

10/pkg.

	Regular	Junior
Assorted	<b>MGS-MC</b>	<b>SMGS-MC</b>
Aqua	<b>N/A</b>	<b>SMGS-A</b>
Blue	<b>MGS-B</b>	<b>SMGS-B</b>
Black	<b>MGS-BLK</b>	<b>SMGS-BLK</b>
Clear	<b>MGS-C</b>	<b>SMGS-C</b>
Green	<b>MGS-GRN</b>	<b>SMGS-GRN</b>
Maroon	<b>MGS-M</b>	<b>SMGS-M</b>
Orange	<b>MGS-OR</b>	<b>SMGS-OR</b>
Purple	<b>MGS-P</b>	<b>SMGS-P</b>
Red	<b>MGS-R</b>	<b>SMGS-R</b>
Silver	<b>MGS-SIL</b>	<b>SMGS-SIL</b>
Teal	<b>N/A</b>	<b>SMGS-T</b>
Violet	<b>N/A</b>	<b>SMGS-V</b>
White	<b>N/A</b>	<b>SMGS-W</b>
Yellow	<b>MGS-Y</b>	<b>SMGS-Y</b>



## G&H® For the Patient

Without Strap

### Mouth Guards

10/pkg.	Regular	Junior
Assorted	<b>MG-MC</b>	<b>SMG-MC</b>
Blue	<b>MG-B</b>	<b>SMG-B</b>
Black	<b>N/A</b>	<b>SMG-BLK</b>
Clear	<b>MG-C</b>	<b>SMG-C</b>
Green	<b>MG-GRN</b>	<b>SMG-GRN</b>
Maroon	<b>MG-M</b>	<b>SMG-M</b>
Orange	<b>N/A</b>	<b>SMG-OR</b>
Red	<b>MG-R</b>	<b>SMG-R</b>
Silver	<b>MG-SIL</b>	<b>SMG-SIL</b>
White	<b>N/A</b>	<b>SMG-W</b>
Yellow	<b>MG-Y</b>	<b>SMG-Y</b>

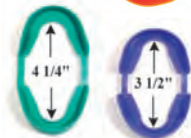

Regular Junior

Tuff Guard

### Mouth Guards

3 openings for unrestricted breathing - convenient dispenser box.

5/pkg.	<b>TGD-MC</b>
Assorted	<b>TGD-A</b>
Aqua	<b>TGD-B</b>
Blue	<b>TGD-BLK</b>
Black	<b>TGD-C</b>
Clear	<b>TGD-GRN</b>
Green	<b>TGD-M</b>
Maroon	<b>TGD-OR</b>
Orange	<b>TGD-P</b>
Purple	<b>TGD-R</b>
Red	<b>TGD-SIL</b>
Silver	<b>TGD-T</b>
Teal	<b>TGD-V</b>
Violet	<b>TGD-W</b>
White	<b>TGD-Y</b>
Yellow	



Aligner Tray Seater

### Chewies

- Best alternative to cotton rolls
- Provides uniform force in specific areas
- Seats aligners with an imperfect fit

20/pkg.	<b>AC-25GMPP</b>
Mint/Green	<b>AC-25PBGPP</b>
Bubblegum/Pink	<b>AC-25WPP</b>
Plain/White	



### Sonic Cleaner

Gets appliances, including retainers, sparkling clean in 5-10 minutes. When used in conjunction with Retainer Brite® tablets. Cleans deep - at 6,500 waves per second, and is a compact 3 1/2" x 4". Operates on two AA batteries (not included). Six-month replacement warranty included.

Ea. **SCL**

*NOTE: Sonic Cleaner and Retainer Brite are US sales only.*



### Retainer Brite®

Retainer Brite® cleaning tablets clean retainers, nightguards, mouthguards, splints and most other removable appliances.

- Helps remove plaque & tartar
- Kills germs & bacteria
- Cleans & brightens appliances

**96** total tablets (bulk packed) **RB-92**

**36** total tablets (bulk packed) **RB-36**

*NOTE: Sonic Cleaner and Retainer Brite are US sales only.*



### Waterpik® Power Flosser

Clinically proven as effective and easier to use than manual floss. Replaceable AA battery included.

Ea. **FLA-220**

#### Refill Tip Cartridge

30 disposable flossing tips per cartridge.

Ea. **FT-01**



### Butler Gum® Eez Thru® Floss Threaders

Helps thread floss under orthodontic appliances.

5 threaders per envelope,  
100 envelopes/box **840P**



# G&H® For the Patient

## Plak Smacker® Ultra Thin Threaders

10 Threaders/Envelope, 100  
Envelopes/pkg.

Ea. **10412**



## Johnson & Johnson® Waxed Floss

5 yards. 144/pkg.

Regular **9863**  
Mint **9864**



## Waxed Floss

55 yards.

Ea. **30611P**



## Butler Gum® Eez Thru® Flossers

Convenient on-the-go flossing. Super  
slick floss slides easily between teeth  
without shredding, breaking, or  
sagging.

3 Flossers/Pack, 48 Packs/Box.

Ea. **891PA**



## Refill Patient Floss

200 yard refill.

Ea.  
Mint **2733**  
Regular **2749**



## Refillable Floss Dispenser

Ea. **207FSD**



## Butler Gum® - Red Disclosing Tablets

Helps detect harmful plaque on teeth.  
The red color reveals overlooked areas  
when brushing or flossing.

250/pkg. **00690112**



## Gum™ Soft-Picks

GUM™ Soft-Picks have 76 soft, rubber  
bristles that easily slide between teeth  
and braces to remove food. They clean  
deep and are more gentle on gums  
than wooden or plastic picks.

5 Picks/Envelope, 72 Envelopes/Box

Ea. **632P**



## Gumpik™ Interproximal Picks

Assorted in 6 bright colors.

48 Picks/Envelope, 48 Envelopes/Box

Ea. **2400**



## Perfecta REV™ Whitening System

Take-home whitening treatment delivers  
optimal whitening in only 15 minutes,  
once a day.

Kit includes: (2) 3cc water based  
whitening gel syringes @ 14%, (1) 4 oz.  
mint finishing rinse

Ea. **4000142**



## Patient Ortho Tote Bags

Plastic starter kit bag. 12" x 15"

100/pkg.

Boy/Girl **TOTEBG**  
Red/White/Blue **TOTERWB**



## Orthodontic Emergency Kit

Specially developed by an  
orthodontist for his patients, the kit  
allows patients to temporarily repair  
broken or loose wires until they can  
make an appointment. Fewer  
emergency calls for you and your staff  
on evenings and weekends, and your  
patients appreciate the value added  
service.

Ea. **969-456**



## G&H® For the Patient



### Patient Survival Kit

Zip pouch survival kit includes handy pouch to insert your business card, rubber grip v-trim dual head toothbrush, spiral brush, 3-minute timer, V-trim travel toothbrush, mint relief wax, floss threaders, 15-yard mint floss spool and mouth mirror.

24 Kits/Box, 6 Boxes/Case  
Ea. **12031P**



### Patient Health Care Kit

Includes travel toothbrush, 2 minute timer, interproximal brush, orthodontic wax, floss threaders, floss and mouth mirror.

Ea. **38008**

### Plaksmaker® Interproximal Brushes

The clear cover conveniently converts into a handle. 5 assorted colors.

144/pkg. **00027**



### Plaksmaker® Interproximal Brushes

Flexible spiral brushes. 4 assorted colors.

144/pkg. **00034**



### Interproximal Brushes

Elastomeric handle for better gripping control with protective cap that is an extended handle.

72/pkg.  
Blue **20046**  
Green **20047**



### Interproximal Brush

This travel interproximal brush is the perfect hygiene tool for patients on the go. The clear cover conveniently converts into a handle, and the brushes are packaged in an assortment of colors. Colors include black, blue, red, purple, green and yellow.

100 brushes/pkg.  
2mm - 3mm **2500**  
2mm - 4mm **2600**  
3mm - 7mm **2650**



Brush cover converts to a handle

### Convenient Travel Toothbrushes

Travel brushes come in assorted translucent colored covers which convert to a handle.

Straight Bristles, 72/pkg. **00129**  
V-Cut Bristles, 72/pkg. **00122**



### Deluxe Travel Toothbrushes

Plastic handle with a color matching opaque textured plastic case that becomes a handle extension. 4 assorted colors. Not individually wrapped.

72/Box **44003**



### Economy Travel Toothbrushes

4 assorted colors. Not individually wrapped.

72/Box **44001**



# G&H® For the Patient

## Disposable Toothbrushes

Soft end rounded bristles with U.S. formulated paste. Straight plastic 6.5" handle w/ narrow neck.

100/pkg.

Pre-Pasted  
Plain

**10917**  
**10918**



## Disposable Toothbrushes

Excellent for short-term use and as a low-cost brush for patients. Pre-pasted brushes are perfect for office visits.

100/pkg.

Regular  
Pre-Pasted

**TB-25PW**  
**TB-25WITH**



## Toothbrush Covers

Assorted colors.

144/pkg.

**200TBX-A**



## Sand Tooth Brushing Timers

3-minute sand timers.

72/pkg.

**20403**



## Cool Mint Listerine®

1.5 liter bottle

**42755**



## Alcohol-Free Listerine® Zero

(6) 1.3 liter bottles

**257-1414**



## 0.4% Stannous Fluoride Gel

This fluoride treatment gel provides the benefits of stannous fluoride, inhibits plaque growth, helps eliminate hypersensitivity, and aids in the prevention of caries.

4.3 oz.

Mint

**004-0102-001**

Bubble Gum

**004-0202-001**

Strawberry

**004-0402-001**

Grape

**004-0802-001**



## Ortho Sil Patient Relief Silicone

50/pkg.

**SBMC**



## BracSil Ortho Relief Silicone

50/pkg.

**700-099**



## Unscented Patient Relief Wax

50/pkg.

Red

**WB-R**

Silver

**WB-SIL**



## Patient Wax Packs

Our wax provides relief from most any source of contact irritation that occurs during orthodontic treatment. Specially formulated to stay in place and not dry out during use.

100/pkg.

Unscented

**PWX536**

Cinnamon

**PWX636**

Wintergreen

**PWX736**





## G&H® For the Patient

### BraceGard™ & Brace Relief™

These silicone patient packs offer superior protection from contact irritation during orthodontic treatment. Silicone provides a smoother, more comfortable surface than wax and will stay in place longer.

**Brace Relief™ Silicone Patient Pack**  
Contains (4) 1 3/4" strips plus (1) 3g tube.  
36 patient packs/box **79DT**

**BraceGard™ Silicone Patient Pack**  
Contains (3) 1 3/4" strips per pkg.  
80/sleeve **79/6DP**

Brace Relief and Brace Gard are trademarks of Infa-Lab, Inc. (Not for export to Europe.)



### Embrace™ Lip Protectors

These flexible protectors fit over brackets and secure onto archwire to protect lip and cheek areas. Especially useful for musicians and others when lip irritation can be a problem. Not suitable for contact sports. Clear, Universal size.

10/pkg. **LPCL01**



**EMBRACE™**  
LIP PROTECTORS

### Elasti Bites Therapeutic Bite Wafers

25/pkg.  
Cherry **EB-25**  
Grape **EB-25G**  
Bubblegum **EB-25PBG**



### Elastics Storage Key Rings

These attractive key rings conveniently store intraoral elastics. They are available in neon assorted pack with orange, yellow, purple, pink, and turquoise - or basic assorted pack of silver, black, dark green, dark red, and dark blue. Each key ring includes one elastic placement tool.

50/pkg.  
Neon Assorted **ESC050**  
Basic Assorted **ESC150**



### Elastics Placement Tool

These handy instruments help patients simplify the positioning of elastics. The double-ended design features a hook for pulling and a notched end for pushing elastics and placing as prescribed. They are available in a neon assorted pack with orange, yellow, purple, pink, and turquoise - or a basic assorted pack of silver, black, dark green, dark red, and dark blue.

100/pkg.  
Neon Assorted **EPT100**  
Basic Assorted **EPT150**



### Demonstration Models

These models are a must for patient and staff education. Manufactured from a durable and color-stable polymer, our models will remain attractive for many years with minimal care. Use with or without included hinge.

Ea. **DEM010H**



*Class I Ideal with attachable hinge.*



Mojo Monkey



Al E. Gator



Ollie Z. Mutt

### Zoo Animal Teaching Aids

Help create a relaxed atmosphere for teaching good oral hygiene to patients of all ages. Animals are fully flossible and equipped with removable tongue and Velcro® toothbrush strap. Puppets allow for animated movement and include a small reservoir to squirt water for added entertainment. These plush animals are great for individual or group presentations. Approximately 15" seated. One toothbrush is included with each animal.

Ea.  
Mojo Monkey **PM901**  
Al E. Gator **PA400**  
Ollie Z. Mutt **PD700**



# G&H® Disinfectants/Cleaners

Towelettes

## Caviwipes®

CaviWipes are durable, nonwoven, nonabrasive towelettes that offer quick, easy-to-use, time-saving convenience. 12 Canisters/Case.

6"x6" - 160 Wipes/Canister **13-1100**  
9"x12" - 65 Wipes/Canister **13-1150**



Towelettes

## Discide® Ultra

12 Canisters/Case.  
6"x6" - 160 Wipes/Canister **60DIS**



Towelettes

## Sani-Cloth® Plus Germicidal

12 Canisters/Case.  
6"x6" - 160 Wipes/Canister **SANLS**



Sani-Cloth® Dispenser

## Wire Wall Mount

Holds Sani-Cloth® canister for convenient dispensing.

Ea. **PLG**

Note: Dispenser will not hold other brands of wipes.



Towelettes

## Sanitex Plus®

12 Canisters/Case.  
6"x6" - 160 Wipes/Canister **SANLC**



Disinfecting Spray

## Lysol® I.C.

19 oz. **95029**



Ultradose

## Tartar & Light Stain Remover

Use one packet per cleaning.

24/Box

**028**



Ultradose

## General Purpose Cleaner

This powder cleans instruments, burs, general equipment, orthodontic appliances, gold and porcelain. One packet makes one gallon of cleaning solution.

24/Box

**UD030**



Prosonic

## General Purpose

Gal.

**21351**



Prosonic

## Tartar & Stain Remover

Gal.

**21352**



## Opti-Cide 3® Disinfectant

4 Gallons/Case.

Gal.

24 oz. w/Pump

**OCP04-128**

**OCS12-024**



## G&H® Disinfectants/Cleaners

### Metrex® Cavicide® Disinfectant

4 Gallons/Case

Gal. **13-1000**  
24 oz. w/Pump **13-1024**



### Discide® Ultra Disinfectant

4 Gallons/Case.

Gal. **3565G**  
Qt. **3565Q**



### Concentrated E-Vac Evacuation System Cleaner

Specially formulated to dissolve organic debris, rope saliva and blood. Powerful non-foaming solution cleans away calcium buildup in the lines. Gallon makes 128 treatments.

Gal. **00107**



### Super-Concentrated PureVac® Evacuation Cleaner

Dissolves away the toughest debris to provide optimal suction.

2 Liter **21113**  
5 Liter **21115**



### Defend® SRG® Evacuation System Cleaner

Gallon makes 128 treatments.

Gal. **SO-9100**



### 3% Glutaraldehyde MicroCide 28® Sterilant

Provides an efficient and safe means for high-level disinfection or sterilization. 4 Gallons/Case.

Gal. **MC28-04-128**



### 2.5% Glutaraldehyde Metricide 28™ Sterilant

Reusable, high-level disinfectant for up to 28 days. 4 Gallons/Case.

Gal. **10-2800**



### 2.5% Glutaraldehyde Procide-D™ Sterilant

Reusable, high-level disinfectant on immersible lensed and delicate instruments for up to 28 days. 4 Gallons/Case.

Gal. **10-2860**



### Non-Glutaraldehyde Sporox II® Sterilant

Powerful hydrogen-peroxide based sterilant and high-level disinfectant for heat-sensitive instruments. 4 Gallons/Case.

Gal. **75156**



### Non-Glutaraldehyde Compliance™ Sterilant

Does not require activation or test strip and can be used at room temperature. 4 Gallons/Case.

Gal. **10-2500**



### Defend General Purpose Cleaner

Non-ammoniated rust inhibitor. 4 Gallons/Case.

Gal. **SO-9400**



### UltraDose® Ultrasonic Cleaning Solution

An excellent cleaner of instruments, burs and orthodontic appliances. Each 1 ounce packet makes one gallon of cleaning solution.

24/Box **012**



# G&H® Disinfectants/Cleaners

## Ortho-Clean® Ultrasonic Cleaner

Gal. **OC401**



## UltraDose® Germicidal Ultrasonic Cleaner

Cleans and disinfects inanimate, non-porous instrument and appliance surfaces.

16 oz. **UD036**



## Dentronix® MP-US Plus

Does not require distilled water. No-rinse formulation saves time and is odorless.

(4) - 8 oz. **DMP-USP**



## Enzymatic Cleaner VibraKleen Tablets

20/pkg. **50037100**



## Crosstex® Efferzyme Tablets

Made from a biodegradable, non-chlorine formulation that contains fast acting protease enzymes. Place 2 tablets in gallon of warm water.

52/Box **JET**



## EZ Scoop Alginate Remover

Ultra-high performance alginate remover and tray cleaner. Non-corrosive, non-toxic and biodegradable.

840g **DP2900**



## EZ Scoop Plaster/Stone Remover

840g **DP2400**



## EZ Scoop Autoclave Cleaner

Ultra-high performance autoclave chamber cleaner. Safely cleans and is non-corrosive and biodegradable.

750g **DP3000**



## Chamber Brite® Autoclave Cleaner

Premeasured packs.

10/pkg. **006-3210**



## Speed Clean® Autoclave Cleaner

16 oz. bottle **953-5770**

## Birex® SE One-Step Germicidal Detergent

(4) 1/8 fl. oz. pkts. **954-0594**



## BluTab™ Waterline Maintenance Tablets

50/pkg. **953-4056**



## PeelPro™ Self-Sealing Sterilization Pouch

Dual internal and external steam and gas sterilization indicators. Autoclavable or chemclavable.

200/pkg.  
2 3/4"x10" **88000**  
3 1/2"x10" **88010**  
5 1/4"x11" **88015**



## Self-Sealing Sterilization Pouch

For steam or dry heat - color indicator.

100/pkg.  
2"x9 1/2" **I0032**  
3"x10" **I0033**  
4"x10" **I0034**  
6"x11" **I0036**



## G&H® Sterilization/Cotton Rolls

### Adenna® Self-Sealing Sterilization Pouch

200/pkg.  
2 1/4" x 4" **SPH2350**  
2 3/4" x 10" **SPH2810**  
3 1/2" x 10" **SPH3510**  
3 1/2" x 6 1/2" **SPH3565**  
5 1/4" x 11" **SPH5311**



### Sure-Check® Sterilization Pouch

Gives you the assurance of confirming all 3 sterilization parameters: time, temperature and presence of steam.

200/pkg.  
5 1/4" x 10" **SCM2**  
3 1/2" x 9" **SCS2**  
3 1/2" x 5 1/4" **SCXS2**  
2.25" x 4" **SCXX2**



### Sure-Check® Sterilization Strips

Indicates all conditions for sterilization have been achieved - time, temperature, and presence of steam.

100/Box **SCK**



### EMS Sterilizer Monitoring Service

The EMS is certified for use in steam, dry heat, and EO gas processes.

12/pkg. **EMS-012**  
52/pkg. **EMS-052**



### Nyclave® Dry Heat Indicator Labels

Pressure sensitive - changes color with dry heat sterilizer temperatures.

125/Box **862-1747**



### Cellulose Indicator Tape

Indicates specific temperature has been achieved during sterilization cycle.

3/4" - 60 yd./Roll **STM**  
1/2" - 60 yd./Roll **STS**



### Highly Permeable CSR Wrap

Use with ETO, steam, gamma irradiation or E-beam sterilization technology.

100/pkg.  
12"x12" **SW12**  
15"x15" **SW15**  
18"x18" **SW18**  
20"x20" **SW20**  
24"x24" **SW24**



### Crosstex® Sani-Tube®

Use in steam, chemical vapor or dry heat (up to 425°F/218°C).

2"x100'/Roll **SI2**  
3"x100'/Roll **SI3**  
4"x100'/Roll **SI4**  
6"x100'/Roll **SI6**



### Richmond/Tidi Cotton Rolls

Braided - Rolls are braided with silky yarn. Non-sterile.

3/8" x 1 1/2" Med. - 2,000/Box **200204**  
4" Medium - 200/Box **201226**  
6" Medium - 200/Box **201208**



**Wrapped** - 100% cotton interior. Wrapped in non-woven fabric and starch-free. Non-sterile.

3/8" x 1 1/2" Med. - 2,000/Box **200404**  
5/16" x 1 1/2" - 2,000/Box **969120**  
3/8" x 6" - 500/Box **969122**

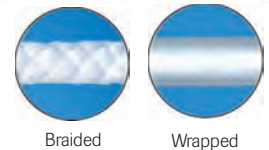

### Crosstex® Cotton Rolls

Non-sterile, made from 100% cotton.

1 1/2" x 3/8" - 2,000/Box **DNAC**



### White Cotton Roll Holder

Holds one pkg. of cotton rolls.

Ea. **1426**



# G&H® Sterilization/Cotton Rolls

## Cotton Roll Dispenser

Hinged lid for easy loading. Holds one pkg. of rolls.

Ea. **207CRD-1**



## Crosstex® Cotton Tip Applicators

1,000/Box

3" **CS-3000**  
6" **CS-6000**



## Spring Action Sponge Dispenser

Spring action releases pads one at a time.

Ea. **4002SD-1**



## Woven Gauze Sponges

Cotton-filled, non-sterile gauze sponges feature a woven gauze facing with an absorbent cotton fill.

2"x2" - 5,000/Box **919000**  
4"x4" - 2,000/Box **908224**



## Non-Woven Gauze Sponges

4-ply, poly/rayon closed weave, non-sterile, nonwoven sponges. Will not catch on brackets.

2"x2" - 5,000/Box **2020-NW**  
4"x4" - 2,000/Box **4040-NW**



## Cotton-Filled Gauze Sponges

8-ply sponges are shred-resistant and are made of 100% cotton filled.

2"x2" - 5,000/Box **CS-0100**



## Defend® Tongue Depressors

100% wood, smooth and splinter-free. 6" in length and non-sterile.

500/Box **TD-9000**



## Vionex® Skin Lotion

Lotion does not contain mineral oil or petrolatum, which breaks down latex. It is not greasy and does not interfere with gloving. Contains Aloe Vera.

8 oz. **10-1318**



## Vionexus® No-Rinse Spray

1 Liter **10-1800**



## Vionex® Hand Wash Gel

No-rinse gel antiseptic handwash.

18 oz. **10-1628**



## Vionex® Hand Soap

Gal. **10-1500**



## Micrell™ Antibacterial

Hand Soap

8 oz. **9752**  
Gal. **9755**



## Moist Sure™ Antibacterial

Hand Soap

Gal. **95728**



## G&H® Paper Towels/Eye Protection

### Sanitize™ Waterless Gel

18 oz. **JWGP**



### Vionex® No-Rinse Spray No-Touch Dispenser

Eliminates cross-contamination.  
Ea. **10-1810**



### 70% Isopropyl Alcohol

32 oz. bottle  
Dispenser **00097  
48**



### Single-Fold - Natural Paper Towels

Made with 100% recycled fiber.  
( 23.50 cm x 26.04 cm )  
16 packs of 250 towels, 4,000 total  
towels.

Ea. **SPC01800**



### Multi-Fold - Natural Paper Towels

Made with 100% recycled fiber.  
( 22.86 cm x 24.13 cm )  
16 packs of 250 towels, 4,000 total  
towels.

Ea. **SPC01920**



### Multi-Fold - White Paper Towels

Made with 100% recycled fiber and  
over 88% post-consumer content.  
9.5" x 9.12" - 16 packs of 250 towels,  
4,000 total towels.

Ea. **GJO21100**



### C-Fold - White Paper Towels

Made with 100% recycled material.  
10" x 13" ( 25.4 cm x 33.02 cm )  
10 packs of 240 towels, 2,400 total  
towels.

Ea. **SPC01095**



### C-Fold Towel Holder

Provides easy access to C-Fold  
absorbent towels.

Ea. **1206**



### UV Protective Safety Glasses

Uvex Skyper and Uvex Skyper Spec  
2000 protective eyewear for use  
without prescription glasses. These  
glasses absorb 99.9% of harmful UVA  
and UVB radiation.

Uvex Skyper **SG**  
Uvex Skyper Spec 2000 **SGU**



### Deluxe Safety Glasses

The fully adjustable temples and  
lightweight nylon frame allow for  
optimal comfort and fit. The molded-  
in nose bridge comfortably fits a wide  
variety of faces.

Clear/Black Frame **99910**  
Amber/Black Frame **99914**  
Clear/Blue Frame **99920**



### Economy Safety Glasses

One-piece construction with defined  
side shields and brow guard for more  
protection.

Clear **CB9255**  
Gray **CB9257**



### Sleek Safety Glasses

Clear **CB9259**  
Gray **CB9261**



### UV Glasses

Ea. **3600**



### Bio-Hazard Waste Bags

Ties included.

10 gal. - 250/Box **PS8653**  
16 gal. - 250/Box **PS8654**  
33 gal. - 100/Box **1961C**



# G&H® Sharps Containers/Barrier Film

Biohazard

## Sharps Containers

1 Qt. **SC-01QT**  
4 Qt. **SC-04QT**  
8 Qt. **SC-08QT**



Latex

## Multi-Use Barriers

For use with pens, pencils, scalars, mirror handles, bite blocks, toggle switches and much more.

500/pkg. **088-058**



## Bite Block Cover

Clear, convenient plastic barriers for use with Pano-X-Ray machine bite blocks. Economical way to reduce cross-contamination, eliminating the need for disinfection or sterilization. 1" x 2"

1000/pkg. **1850**



Siemens

## Bite Block Cover

Clear, convenient plastic barriers for use with Siemens X-Ray machine bite blocks. Economical way to reduce cross-contamination, eliminating the need for disinfection or sterilization. 1 1/2" x 3"

500/pkg. **1850S**



## T-Light Handle Protector

Easy to use elastic barrier, one size fits virtually all T-Bar lamp handles. Made of natural rubber latex.

250/Box **088-015**



Clean Cover

## T-Light Handle Protector

Reduce the risk of cross-contamination when touching the light repeatedly. 5 3/4" x 4 1/4"

500/Box **1914**



Air/Water

## Syringe Tip Cover

Designed to be used with virtually all air/water syringes. Easily slides over the existing syringe tip. The hub design provides for easy, one-handed tip rotation. Dispose of after each patient.

100/pkg. **1950**



Air/Water

## Syringe Tip Cover

Offers convenient protection against cross contamination. 2 1/2" x 10"

500/pkg.  
Closed End **915002**  
Open End **915006**

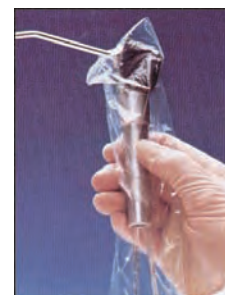

## Surface Barrier Film

Surface barriers reduce the risk of cross contamination caused by airborne aerosols, splash and spatter. 4"x6" (10x15cm).

1,200 Ft.  
Blue **PS1250B**  
Clear **PS1250C**  
Green **PS1250G**  
Purple **PS1250P**

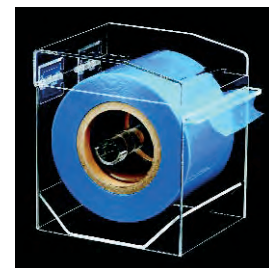

Eyewear

## Disinfecting Tray

Includes one tub with lid containing 2 white plastic tray holders (one for immersing eyewear into disinfectant and one for drying eyewear beside the container). Dimensions 7 1/4" x 9" x 3".

Tray - w/4 pair glasses **1869**  
Tray - without glasses **1869B**





## Looking for lab supplies?



**You'll find what you need in our full line of quality products!**

*From lab supplies to clinical treatment products, G&H offers more than 6,000 brand-name items and precision G&H manufactured products.*

Order online at: [GHOrthodontics.com](http://GHOrthodontics.com)

Low/Medium Heat

### Compound Sticks

15/pkg.

Red/Low Heat **6060300**

Green/Low Heat **6060500**

Brown/Medium Heat **6060700**



Hygienic

### Bite Wafers

Without Foil - 50/pkg.

**H00839**

With Foil - 24/pkg.

**H00825**



### Utility Wax Strips

75/Box

**UWX1164**

450/Box

**700-117**



Miltex®

### Beauty Wax

**Pink** - 1 lb.

Soft

**116-56450**

Medium

**116-56510**

X-Hard

**116-56630**

**Pink** - 5 lb.

Soft

**117-56470**

Medium

**117-56530**

X-Hard

**117-56650**

**White** - 1 lb.

Soft

**120-57130**



Miltex®

### 10X Pink Wax

1 lb.

**195-55500**



Miltex®

### Sticky Wax

24/box

Red

**180-58351**

Brown

**180-58291**



Modern Materials®

### Bite Wax Sheets

Yellow

1 lb.

**50093614**

5 lb.

**50093654**



# G&H® Lab Supplies

## Modern Materials® Utility Wax Strips

Large - 75 Strips **50094191**



## Modern Materials® Copr wax

84/Box **50092178**



## Modern Materials® Check Bite

Yellow Wafers  
120/pkg. **50095194**



## .003 Thickness Cephalometric Tracing Paper

8"x10", 100 Sheets/Pad  
Ea. **ATP100810G**



## Pozzi®/Leone® Ortho Resin Acrylic

**Ortho Resin Acrylic Kit**  
Kit includes 16 oz. Powder & 8 oz. Liquid

Clear Kit **19822/C**  
Pink Kit **19822/P**

**Ortho Resin Liquid** (Monomer)  
8 oz. Clear **20024/C**  
8 oz. Pink **20024/P**

**Ortho Resin Powder** (Polymer)  
16 oz. **20032**



## Leone® Glitters Ortho Resin

50g  
Silver **R4300-00**  
Gold **R4301-00**  
Multicolor **R4302-00**  
Blue **R4303-00**  
Red **R4304-00**



## Trim-Rite® Releasing Agent

Helps prevent vacuum formed plastic from sticking to models.

12 oz. **21004**



## ProForm® Retainer Material

5"x5" - .030 Super Clear  
25/pkg. **9615025**  
50/pkg. **9614816**



## G&H® Lab Supplies

ProForm®

### Mouthguard Resin Material

	.160 - 25/pkg.	.160 - 300/pkg.	.200 - 12/pkg.
Clear	<b>9597940</b>	<b>9598010</b>	<b>9601215</b>
Yellow	<b>9597760</b>	<b>9597930</b>	<b>9601535</b>
Green	<b>9597700</b>	<b>9597890</b>	<b>9601485</b>
Blue	<b>9597680</b>	<b>9597880</b>	<b>9601225</b>
Red	<b>9597740</b>	<b>9597910</b>	<b>9601515</b>
Black	<b>9597660</b>	<b>9597870</b>	<b>9601275</b>
Orange	<b>9597720</b>	<b>9597900</b>	
Purple	<b>9597725</b>	<b>9597905</b>	
White	<b>9597750</b>	<b>9597920</b>	



Essix®

### Plastics

100 Sheets/pkg.

A+ 5" Square/Vac. .030"	<b>10035</b>
A+ 5" Square/Vac. .040"	<b>10045</b>
A+ 5" Square/Vac. .060"	<b>10065</b>
A+ 5" Square/Vac. .080"	<b>10085</b>
A+ 125mm Square/Bio. .030"	<b>10030</b>
A+ 125mm Square/Bio. .040"	<b>10040</b>
A+ 125mm Square/Bio. .060"	<b>10060</b>
A+ 125mm Square/Bio. .080"	<b>10080</b>
A+ 125mm Round/Bio. .030"	<b>11030</b>
A+ 125mm Round/Bio. .040"	<b>11040</b>
A+ 125mm Round/Bio. .060"	<b>11060</b>
A+ 125mm Round/Bio. .080"	<b>11080</b>
Ace 5" Square/Vac. .030"	<b>1A350</b>
Ace 5" Square/Bio. .030"	<b>1A347</b>
Ace 5" Round/Bio. .030"	<b>1A325</b>
Ace 5" Square/Vac. .035"	<b>1AH50</b>
Ace 5" Round/Bio. .035"	<b>1AH25</b>
Ace 5" Square/Vac. .040"	<b>1A450</b>
Ace 5" Square/Bio. .040"	<b>1A478</b>
Ace 5" Round/Bio. .040"	<b>1A425</b>
C+ 5" Square/Vac. .040"	<b>1C500</b>
C+ 125mm Square/Bio. .040"	<b>1C478</b>
C+ 5" Round/Bio. .040"	<b>1C125</b>



### Therma Frost™ Refrigerant Spray

Chairside use for chilling Thermal Activated NiTi. For use outside the oral cavity only.

10 oz. **TFROST**



### Headband Style Magnifier

One-touch design - switch between 1.8X, 2.3X, 3.7X & 4.8X

Ea. **1150120**



Compact

### Micro Torch

Lightweight and compact, this torch is equipped with an instant electronic ignition system for reliable starting. Includes a removable base for free-standing or handheld use.

Ea. **MT-9000**



Leone®

### Silver Solder Wire Form

Cadmium free. Silver content: 55%. Wire form, 0.40 mm in diameter. 10g approx.

Ea. **R0222-00**



Leone®

### Silver Solder Tape Form

Cadmium free. Silver content: 55%. Tape form, 1 x 0.5 mm. 10g approx.

Ea. **R0223-00**



Leone®

### Silver Solder Straights

Cadmium free. Silver content: 55%. Rods, 1 mm in diameter. 10g approx.

Ea. **R0224-00**



### Solder

0.031" 1/4 troy ounce, 6 ft.

Ea. **SLVSLD**



Leone®

### Fluoride Flux Paste

1 oz. **R0226-00**



### Flux

1/4 lb. **75012**



4" Diameter

### Rag Wheel

Ea. **1180160**



3" Diameter

### Heatless Stone

Ea. **1900080**



# G&H® Equipment

Prestige 2100

## Autoclave Sterilizer

Mechanical interlock system prevents lid from being removed while pressure remains in the chamber. Gasket offset device prevents pressure build up if lid is not correctly fitted. At only 9.9 pounds net weight with chamber size of approx. 8" x 9", this is ideal for most sterilization applications.

- Chamber size: 8.25" x 9"
- Size: 14" x 13.5"
- Cycle time: 26 mins.
- Capacity: 2.37 gal.
- With basket

Ea. **21006**

**Green Lid Gasket 219500**



Saniclave 200

## Steam Sterilizer

A front loading, corrosion resistant, stainless steel chamber and door make this steam sterilizer extremely easy to load and clean.

Ea. **RS-SC-200**

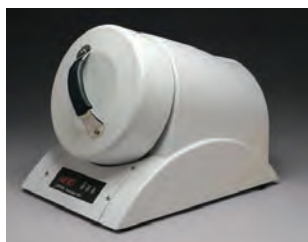

Cox®

## Dry Rapid Heat Sterilizer

This sterilizer utilizes dry heat rather than steam and pressure. It won't corrode, dull or pit your instruments or cause them to rust, thus extending the life of every costly instrument.

- 6-minute sterilization
- Instrumentation rack
- Mesh basket
- Cooling rack
- Cooling fan
- 110v

Ea. **Z-COX-N-110V**



Danville Engineering®

## MicroCab+

MicroCab+ is the most effective sandblast and grinding containment system available. Custom ergonomic design offers integrated handle, bright fluorescent light and ultra quiet fan/filter. Dimensions: 6.2" H x 8.7" W x 10.5" D.

- Small & compact, great space saver
- Super quiet suction system
- Extra large internal workspace
- Swing open filter access
- 110v

Ea. **91010**

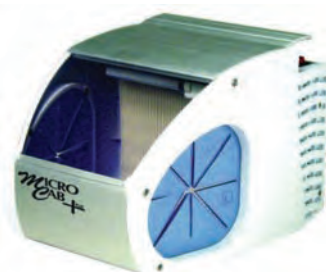

Please note individual component parts exist for MicroCab+ (New), MicroCab Plus +, and MicroCab units. Please verify which unit you are ordering components for. Appropriate components for each unit are available as listed.

## MicroCab Filter

Fits MicroCab, MicroCab Plus+, and MicroCab+. (New).

Ea. **49055**



## MicroCab Window

For MicroCab only.

(MicroCab+ and MicroCab Plus+ window parts listed below).

Ea. **49105**

Protective Shield, 10/pkg. **201359**



## Replacement Windows

MicroCab Plus+, 10/pkg. **91286**

MicroCab+ (New), 10/pkg. **93817**

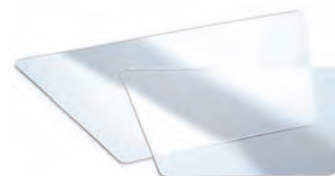

## Microcab Hand Guards

MicroCab, 2/pkg. **59024**

MicroCab Plus+ AND  
MicroCab+ (New), 2/pkg. **91518**



Danville Engineering®

## MacroCab Plus

Compact, yet larger than MicroCab, unit offering an efficient and comfortable design where you only insert your fingers with handpiece to work. Bright, fluorescent light provides ideal illumination. Featuring built-in dust collection/filtration system.

- Dimensions: 7" H x 10" W x 14" D.
- Large, compact and versatile for easy use
- Super quiet suction system
- Built-in bright, fluorescent lighting
- Swing open access to easily clean filter
- 110v

Ea. **91556**



Please note individual component parts exist for MacroCab Plus (New), and MacroCab units. Please verify which unit you are ordering components for. Appropriate components for each unit are available as listed.

## MacroCab Filter

MacroCab, Ea. **116545**

MacroCab Plus, Ea. **91557**



## MacroCab Window

For MacroCab only.

Ea. **185508**

Protective Shield, 10/pkg. **201360**



## G&H® Equipment

### Replacement Windows

For MacroCab Plus only.  
10/pkg.

**93960**



### MacroCab Hand Guards

MacroCab, 2/pkg.  
MacroCab Plus, 2/pkg.

**59026**  
**91518**



MacroCab  
Hand Guard

MacroCab Plus  
Hand Guard

### Handler® Etcher Catcher Dust Collector

The Etcher Catcher is constructed to be ergonomically accommodating when used with hand held blasting pencils, preventing dusts from collecting on table tops and surrounding areas. Dimensions: 11" W x 9" H x 16" D.

- Includes filter & self-contained dust collector
- Collects aluminum oxide when blasting
- Ergonomically designed
- Large yet compact for space savings

Ea. **52CSU**



### Handler® Porta-Vac Dust Collector

Will collect 0.5 microns of dust and larger particles. The durable white powder coated heavy gauge steel frame is built to last. Dimensions: 8½" W x 12" H x 12" D.

- Self-contained light dust collector
- Collects 0.5 micron or smaller
- Ready to use right out of the box
- Replaceable filter and shield

Ea. **550**

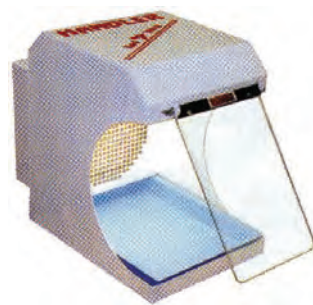

### Aluminum Oxide

1 lb.

90 Mic. - Tan  
50 Mic. - White

**15201**  
**15301**



### Handler® Super Sucker Dust Collector

Designed to provide maximum suction capacity, the No.62 Super Sucker develops 225 cfm (6.36M3/min) suction capacity through two top inlets. Dimensions: 14¾" wide x 8½" deep x 17¾" high.

- Secondary filter traps dust particles to 0.5 microns
  - Charcoal filtration reduces monomer odors
  - Compact size fits bench top or under bench
- Includes:  
(1) 87210 Fishmouth  
(1) 87 Fishmouth  
(4) 66C-6 Clamps  
(1) 10' 66C-4 Flexi Hose

Ea.

**62**



### Danville Engineering® MicroEtcher II-A

The MicroEtcher IIA is recognized as one of the most valuable tools for orthodontists. The MicroEtcher provides precise surface micro-roughening, improving bond strength up to 400%. Surface area and surface reactivity is dramatically increased for maximum bond. Sandblasting is fast and easy with most surface roughening procedures requiring only a few seconds.

- Totally autoclavable
- Fast & easy cement removal
- Finger button control

Ea.

**22005-01**



### Danville Engineering® MicroEtcher II

All the performance and applications offered by the model IIA. Only the nozzle is autoclavable. All stainless construction. Replaceable carbide tip.

- Nozzle can be rotated 360° and removable for autoclaving
- Fast & easy cement removal
- Finger button control

Ea.

**22000-03**



# G&H® Equipment

## Danville Engineering® MicroEtcher ERC

The economical MicroEtcher ERC model offers the same performance and durability as the MicroEtcher II and II-A. The nozzle rotates 360° but is not removable. ERC can be cold sterilized but not autoclaved. It is not intended for intraoral use, and features stainless construction.

- Finger button control
- Clean & prepare orthodontic brackets
- Nozzle can be swivelled 90° to either side

Ea. **21000-03**



## Replacement Oxide Jars

Ea. **201502-00**  
Microetcher II/II-A **25026**  
Microetcher ERC



## Quick Disconnect Kit

Quick disconnect kits allow easy connection to house air. Full pressure air line is cut and slid onto barbed tee.

Ea. **44000**  
Operator **44007**  
Lab



## Quick Disconnect Male Assembly

Ea. **44020**



## Direct Lab Connector

For all microetchers permanent.  
Ea. **44025**



## Microetcher II Nozzle

Interchangeable nozzles for the MicroEtcher II and II-A. New smaller .032" tip is ideal for intraoral applications as it reduces the amount of dust and provides for a more focused pattern of abrasive.

Ea. **201802-00**  
.048" Reg. **201865-00**  
.032" Slim



## Sand Traps for Microetcher

Soft plastic spheres slip onto high speed suction, and with the MicroEtcher tip inserted through the top opening, traps the abrasive.

15/pkg. **22006**



## Etchmaster® Cordless Starter Kit

Kit includes: Cordless EtchMaster® Handpieces, 5 Regular and 5 Lingual Small BE/50 Hard Abrasive Lingual Tips and 4 CO2 Cartridges.

Kit **EM**  
Lingual Component Pack **EMCL**  
CO2 Cartridge **EMCO2**  
Regular Component Pack **EMCR**



## Etchmaster® 4-Hole Handpiece Starter Kit

Kit includes: Cordless EtchMaster® Handpiece, 6 Regular and 6 Lingual Small BE/50 Hard Abrasive Lingual Tips and 4 CO2 Cartridges.

Kit **EMHA**



## Hard Abrasive Tips

50 micron aluminum oxide. Typically for restorative, preventive sealants, orthodontic brackets, and cosmetic bonding.

25/pkg. **EMTLL**  
Large - Lingual **EMTRL**  
Large - Regular **EMTLS**  
Small - Lingual **EMTRS**  
Small - Regular



## Micro Lab 350 Micro Motor

- On/off foot pedal
- 0-35,000 rpm
- Forward/reverse direction

Ea. **MICROLAB350SETA**



## G&H® Equipment

Ram Power 35

### Micro Motor/ Variable Speed

Variable speed dial 0-35,000 rpm. Safety overload protection and reset button. Selection for forward/reverse direction. Variable speed foot pedal.

Ea. **RAMPOWER35SETB**



Ram Power 45

### Micro Motor/ Variable Speed

Variable speed dial 0-45,000 rpm. Safety overload protection and reset button. Selection for forward/reverse direction. Variable speed foot pedal.

Ea. **RAMPOWER45SETB**



Ram Pro 500

### Micro Motor/ Variable Speed

Variable speed dial 0-35,000 rpm. Safety overload protection and reset button. Selection for forward/reverse direction. Variable speed foot pedal. Microprocessor controlled dynamic braking.

Ea. **RAMPRO500NSETB**



RX 300

### Micro Motor/ Variable Speed

Variable speed dial 3,000-35,000 rpm. Safety overload protection and reset button. Selection for forward/reverse direction. Variable speed foot pedal.

Ea. **RX300VAR**



Handler®

### Chuck Changer w/26A Lathe

The 16 chuck/changer is factory installed to the right side of a 26A low base, red wing lathe. The movement of the activating handle allows the technician to change from 1/4" [0.6cm] to 3/32" [0.2cm] burs, mandrels and chuck accessories without stopping the lathe.

Ea. **16B**



Handler

### Red Wing Lathe - 1/4 HP

A full 1/4 HP, 1725/3450 rpm lathe for use on top of laboratory bench (115 volts/60Hz). Its 4 1/2" [11.4cm] shaft height allows for easy use by the technician with hands resting on the tabletop. Shipped with standard, tapered shafts, each lathe includes a right and left chuck remover.

Ea. **26A**



Jacobs Type

### Jr. Chuck

This chuck is designed for use on polishing motors which have a 1/2" [1.3cm] shaft.

Straight Shaft **8**  
Tapered Shaft **8T**



Handler®

### Arbor Band Chuck Right

Ea. **13R**



### Stone Chuck Right

Ea. **30620**



Handler®

### Tapered Brass Chuck Left

Ea. **7BL**



Handler®

### Tapered Brass Chuck Right

Ea. **7BR**



Handler

### Red Wing Lathe 1/3 HP 110v

A 1/3 HP two speed 1725/3450 rpm high base polishing motor with 6" shaft height. Built to accommodate larger diameter buffs and chuck accessories, the 28H provides added torque for the frequent polisher. The unit is shipped with standard tapered shafts with chuck removers.

Ea. **28H**



# G&H® Equipment

## Handler® Chuck Changer

w/Accessories **16**  
w/o Accessories **16-0**



## Ray Foster® Variable Speed Lathe

A powerful 1/3 HP in a totally enclosed, dust and splash-proof housing for trouble free polishing and grinding. The unique variable speed lathe provides up to 4,000 rpm, giving you more power and speed than ever in a counter top lathe.

Ea. **PR90**



## Ray Foster® Variable Speed Lathe Quick Chuck

A powerful 1/3 HP in a totally enclosed, dust and splash-proof housing for trouble free polishing and grinding. The unique variable speed lathe provides up to 4,000 rpm, giving you more power and speed than ever in a counter top lathe. Quick-change chuck mounted on right side.

Ea. **PR92**



## Ray Foster® 2-Speed Lathe 1/3 HP

Ea. **PR75**



## Ray Foster® 12" Ortho Trimmer + Diamond Wheel

Same great features of the MT15 but with a diamond grinding wheel. The 100% diamond grinding surface cuts with superior speed and consistency, and provides a smoother finish than similar grades of other abrasive media.

Ea. **MT15D**



## Ray Foster® 12" Ortho Trimmer w/Accessories

Equipped with the orthodontic angulating work table. Accessories supplied with the orthodontic model trimmer include vertisquare, angle guide, and 70mm adjustment gauge. 1/2-HP motor, with 1.25 service factor producing .625 HP actual power. (1) 12" dia., 1/4" thick grinding wheel. Pictured with optional water spray attachment.

Ea. **MT15A**



## Ray Foster® 12" Ortho Trimmer w/Accessories + Diamond Wheel

Same great features and accessories of the MT15A but with a diamond grinding wheel. The 100% diamond grinding surface cuts with superior speed and consistency, and provides a smoother finish than similar grades of other abrasive media. Pictured with optional water spray attachment.

Ea. **MT15AD**



## Whip-Mix® 12" Diamond Deluxe Trimmer w/Accessories

This 12" model features a fully adjustable work table with angle ranges from 85° to 120° from the grinding wheel surface. A hinged front cover held by a single wing nut allows easy access to change or reverse the abrasive wheel. Equipped with fully adjustable work table and blue wonder diamond wheel. 1/2-HP motor.

Ea. **25143**

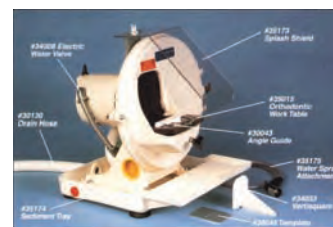

## Handler® Ortho-Angulator

Angulator attachment for precise grinding of angles onto plaster or stone models. Easily set to desired angle up to 120° from mid-line in 5° increments. Produces precise angled models for study and presentation. For Handler 10" [25cm] or 12" [30cm] model trimmers.

Ea. **32-14INS**





## G&H® Equipment

Handler®

### 12" Trimmer 1/2 HP 110v

A 12" [30cm] diameter model trimmer powered by a 1/2 HP ball bearing, capacitor start motor. Shipped complete, ready for use with minor set-up. Finished with a durable, baked coating.

- Full radius perforated no-splash water spray
- All accessories for immediate use included
- Front swings open for easy cleaning
- Reverse groove grinding wheel for fast cutting
- No-stall motor
- Easy change wheel

Ea. **32**



Ray Foster®

### 12" Ortho Trimmer

Equipped with the orthodontic angulating work table, the Ray Foster 12" model trimmer speeds trimming of study models, and produces accurate and attractive results. 1/2-HP motor, with 1.25 service factor producing .625 HP actual power. (1) 12" dia., 1/4" thick grinding wheel.

Ea. **MT15**



Wehmer®

### Dual Wheel Model Trimmer 110v

This machine is equipped to get the job done at a cost-effective price point. 1/2-HP motor with 12" coarse and fine carborundum wheels. Standard orthodontic table and tools.

Ea. **108/110**



Wehmer®

### Pro Dual Wheel Diamond Model Trimmer 110v

Our most popular dual wheel trimming package. 50% more horsepower coupled with diamond cutting technology on the coarse wheel side provides 30-40% faster trimming. 3/4-HP motor with 12" coarse and fine carborundum wheels. Standard orthodontic table and tools and electric water control valve.

Ea. **108P/110**



Wehmer®

### Ultimate Dual Wheel Diamond Trimmer 110v

With orthodontic work table and accessories.

Ea. **108PFLE/110**



Wehmer®

### Single Wheel Orthodontic Model Trimmer

Precision table and tools allow rough trimming to standard angles with a machine that takes up less space and is easy to maintain. 1/2-HP motor with a 12" coarse carborundum wheel.

Ea. **125-0**



Wehmer®

### Dual Trimmer Drain Tray

For 108 Dual Wheel Trimmer. Elevates the dual trimmer less than 2" while significantly enhancing drainage capability and containing splash and splatter. Great with diamond wheels.

Ea. **1126**

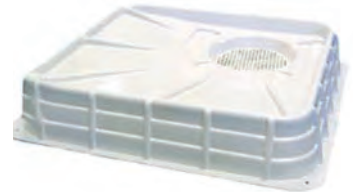

Wehmer®

### 12" Carborundum Trimming Wheel Fine

Trim on both sides of wheel.

Ea. **3305**



Wehmer®

### 12" Diamond Trimming Wheel Coarse

Fits Wehmer® trimmers only. Natural diamond abrasive with epoxy-glass backing. 3/16" thickness.

Ea. **1150**



Wehmer®

### Electric Water Valve

Automatically turns water on and off with trimmer power switch. For dual-wheel 110v trimmers.

Ea. **3336**



# G&H® Equipment

## Wehmer® Work Light

Provides added illumination at the work area. Turns on and off with main power switch of trimmer. For dual-wheel 110v trimmers.

Ea. **3390**



## Wehmer® Trimmer Shield & Mounting Bracket

Shatterproof polycarbonate keeps debris and water out of your face. Shield removes easily for cleaning and can be moved between coarse and fine wheel. For dual-wheel 110v trimmers.

Ea. **3500**



## Wehmer® Dual Trimming Table

Standard trimming table with knob.

Ea. **3170**



## Whip Mix® Model Trimmers

10" - 2 position work table & 10" x 1/4" coarse abrasive wheel.

Ea. **09474**

12" w/ fully adjustable work table & 12" x 1/4" coarse abrasive wheel.

Ea. **09644**



## Whip Mix® 12" Deluxe Model Trimmer

Equipped with accessories: electric water valve, water spray, attachments, and splash shield. (Sediment tray not included with any trimmer)

Ea. **09512**



## Whip Mix® 12" Deluxe Ortho Trimmer

Orthodontic work table (No diamond wheel). Equipped with accessories: electric water valve, water spray, attachments, and splash shield. (Sediment tray not included with any trimmer)

Ea. **09601**



## Whip Mix® General Purpose Vibrator

Provides quiet, long lasting performance. The vibrator features variable intensity vibration, ergonomic design and an easily detachable rubber top for convenient cleaning. 4 1/4"

Ea. **10650**



## Whip Mix® Heavy Duty Vibrator

Designed to provide an infinite range in vibration, with long or short wave options and variable intensity in both wave length options. Also has an easily detachable rubber top for convenient cleaning. 6" x 8"

Ea. **10675**



## Keystone® Vibrator

A heavy-duty vibrator powerful enough to be used in all types of labs but small enough to work great in an office. This unit has a weighted aluminum base for stability, a 4" diameter rubber top, 3-speed control switch and rubber suction feet to hold the unit in place.

Ea. **7000352**



## Ray Foster® Variable Speed Vibrator

This vibrator is excellent for general purpose use. Solidly constructed with a cast metal housing, 4 1/4" (10.8 cm) diameter removable plastic top and a variable speed control option.

Ea. **DV34**



## G&H® Equipment

Ray Foster®

### Heavy Duty Vibrator

The DV36 Vibrator provides high vibration intensity with a three-speed switch. It has a removable rubber top measuring 6½" (16.5 cm) diameter.

Ea. **DV36**



Ram®

### Vibrator 4" Round

4" round table with removable or replaceable cover. Has variable speed dial to adjust the power.

Ea. **VIB**



Ram®

### Vibrator 6"x8" Table

Ea. **VIBLG**



### Metal Plaster Trap

An excellent plaster trap for offices or small labs. Top-mounted drain valve offers instant runoff benefits and the side sight-hole shows when the internal bag is filled. Aluminum construction with removable poly bags. 2¾ gallon capacity. 10½" H x 9¼" W. 10 year warranty.

Ea. **7000360**



### Plaster Trap Liners

6/pkg. **7000403**



Disposable

### Plaster Trap Kits

Easy way to dispose of plaster while conforming to EPA issues, the plaster traps are easy to install and change. Includes 2 attachment hoses, end caps, fittings, bucket & lid.

3.5 Gal. **7000365**  
5 Gal. **7000366**



Disposable

### Plaster Trap Buckets

3.5 Gal. **7000367**  
5 Gal. **7000368**



Disposable

### Plaster Trap Replacement Hoses

2/pkg. **7000369**



Handler®

### Plaster Bin

A three compartment plaster bin which may be hung on the wall or placed on a benchtop. Each compartment of this plaster bin is built to hold 25 lbs [11.3 Kg] of stone or plaster. Special design prevents gypsums from pushing out from lower access door when plaster bin is being filled. All metal construction.

Ea. **81C**



8 Quart

### Pressure Pot

This pressure pot features a heat control thermostat and an internal temp gauge allowing for an accurate reading. Internal diameter of 9.5" and depth of 6.75".

Ea. **66041**



6 & 9 Quart

### Pressure Pots

Both sizes are large enough to contain a model and articulator.

6 Qt. **T1330-00**  
9 Qt. **T1335-00**



Hydraulic Curing Unit

### Pressure Pot

Internal pressure can be generated either hydraulically using water or air can be added from a compressor. The pressure pot is large enough (6" diameter by 6" deep), to hold a standard reline jig or smaller articulator.

Ea. **9622760**



# G&H® Equipment

Whip Mix®

## Vacuum Power Mixer w/Accessories

300ml & 500mL Vac-U-Mixers, plastic tubing & connections.

Ea. **29181**



Whip Mix®

## Ortho Vacuum Power Mixer Plus 110v

The combination unit is equipped with two drive shafts which rotate at different speeds. The faster speed (1,725 rpm) reduces mixing time required for small quantities (90 gram or less) of investment. The slower speed (425 rpm) is for all mixing purposes, with or without vacuum.

Ea. **29262**

Whip Mix®

## VPM2 Programmable Vacuum Mixer

The VPM2 is designed for vacuum mixing all types of gypsums, plasters and investments. You can enter up to 30 separate programs using several parameters to custom mix a material. Utilizing multiple stages, the VPM2 can be programmed for time, speed and paddle direction.

Ea. **29339**



Whip Mix®

## Vac-U-Mixer Bowls w/Paddle Assembly

For vacuum mixing stone, alginate, investment or plaster.

Ea. **200mL, 100 g cap. #6400 08672**  
**300mL, 150 g cap. #4450 08702**  
**500mL, 350 g cap. #6500 08761**  
**875mL, 800 g cap. #6600 08834**



Whip Mix®

## 1200 ML Vac-U-Mixer Stainless Steel Bowl w/Lid

For vacuum mixing stone, alginate, investment or plaster.

1200mL (1,000 g capacity)  
Ea. **08842**



Wehmer®

## Vacuum Spatulator Wall Mount 110v

Includes (2) 800cc bowls, bowl covers & agitators.

Ea. **107/110**



Wehmer®

## Vacuum Spatulator w/Stand 110v

Includes table stand, (2) 800cc bowls, bowl covers & agitators.

Ea. **107S/110**



Wehmer®

## Vacuum Spatulator Pro w/Stand 110v

Includes table stand, (2) 1,000cc stainless steel bowls.

Ea. **107SP/110**



Whip Mix®

## Flexible Vac-U-Mixer Bowl

Flexible Vac-U-Mixer VPM2 mixing unit. (Holds 875 mL or 650 g)

Ea. **15675**



Catalina®

## Waterbath 110v

The unit is equipped with a stainless steel basin, built-in thermometer, thermostat control and riser tray. Adjustable temperature settings range from 100° F - 212° F. The stainless steel basin measure 10<sup>3</sup>/<sub>8</sub>" x 6<sup>3</sup>/<sub>8</sub>" x 4" and is capable of holding 3<sup>1</sup>/<sub>2</sub> quarts of water. Insert tray is sold separately.

Ea. **42900**

**Insert Tray**  
Ea. **42901**



## G&H® Equipment

### Catalina® Waterbath 2000 110v

The unit is equipped with a stainless steel basin, detachable thermometer, and thermostat control. Adjustable temperature settings range from 100° F - 212° F. The stainless steel basin measure 6<sup>3</sup>/<sub>8</sub>" x 6<sup>3</sup>/<sub>8</sub>" x 4" and is capable of holding 1<sup>1</sup>/<sub>2</sub> quarts of water. Insert tray is sold separately.

Ea. **42904**

**Insert Tray for Catalina® 2000**  
Ea. **42905**



### Whipmix® Waterbath 110v

Digital temperature control with indicator light, stainless steel casing, removable stainless steel pan, and unit stops heating when pan is removed.

Ea. **05350**



### Sultan Pro-Sonic® 300 3/4 Gal. Unit

Tank size: 9.5" x 5.5" x 4" (24.1 x 14 x 10.2 cm)  
Overall size: 13.5" x 12" x 11.5" (34.3 x 30.5 x 29.2 cm)  
Tank capacity: .075 gal (2.8 L),  
Mechanical timer.

Ea. **61028**



### Sultan Pro-Sonic® 600 1.5 Gal. Unit

Tank size: 11.5" x 6" x 6" (29.2 x 15.2 x 15.2 cm)  
Overall size: 16" x 12" x 14.5" (40.6 x 30.5 x 36.8 cm)  
Tank capacity: 1.5 gal (5.71 L),  
Mechanical timer.

Ea. **61057**



### Sultan Pro-Sonic® 1000 2.5 Gal. Unit

Tank size: 11.5" x 9.5" x 6" (29.2 x 24.1 x 15.2 cm)  
Overall size: 16" x 15.5" x 14.5" (40.6 x 39.3 x 36.8 cm)  
Tank capacity: 2.5 gal (9.5 L).  
Mechanical timer.

Ea. **61095**



### Sultan Pro-Sonic® 2000 5.5 Gal. Unit

Tank size: 19.5" x 11.5" x 6" in (49.5 x 29.2 x 15.2 cm)  
Overall size: 24" x 18" x 14.5" in (61 x 45.7 x 36.8 cm)  
Tank capacity: 5.5 gal (20.8 L).  
Mechanical timer.

Ea. **61099**



### Coltene Whaledent® BioSonic® Ultrasonic Cleaner UC-125

Selectable cleaning cycle, countdown timer, solution tracking function to inform how long the solution has been in use. 1.25 gal (2.84 L)  
Overall dimensions: L 16.5 x W 10.5 x H 13.75" (L 42 x W 26.7 x H 35 cm)  
Tank dimensions: L 11.25" x W 5.62" x H 5" (L 28.6 x W 14.3 x H 12.7 cm)

Ea. **UC125B115**

**Basket for UC-125**  
Ea. **UC151**



### Coltene Whaledent® BioSonic® Ultrasonic Cleaner UC-300

Overall dimensions: L 19 x W 12 x H 12.25" (L 48.26 x W 30.48 x H 31.12 cm)  
Tank-dimensions: L 14 x W 9 x H 6.75" (L 35.56 x W 22.86 x H 17.15 cm)  
Tank capacity 3.8 gal (14.4 L)

Ea. **UC300B115**

**Basket for UC-300**  
Ea. **UC310**



### L&R® Sweepzone 200 w/Timer & Drain

Standard timer and drain.  
Overall dimensions: L 12.6 x W 6.9 x H 8.25" (L 32.1 x W 1.5 x H 21 cm)  
Tank dimensions: L 11.75 x W 6 x H 4" (L 29.8 x W 15.2 x H 10.2 cm)  
Tank capacity: 1 gal (4 L)

Ea. **SW902**



# G&H® Equipment

L&R®

## Sweepzone 310 w/Timer & Drain

Standard timer and drain. Fan cooled.  
Overall dimensions: L 16.5 x W 10 x H 12"  
(L 41.9 x W 25.4 x H 30.5 cm)  
Tank dimensions: L 15.5 x W 9 x H 6"  
(L 39.4 x W 22.9 x H 15.2 cm)  
Tank capacity: 3.25 gal (12.3 L)

Ea. **SW910**



Accessories sold separately

L&R®

## Solid Basket

For 200/300 units.

Ea. **18666**



L&R®

## Mesh Basket

For 200 series units only.

Ea. **19103**



Aluminum

## Splash Pans

### 6" Splash Pan

12" high x 6" wide x 10" deep  
[30cm x 15cm x 25cm] with insert pan.

Ea.  
Light on left side **83WL-L**  
Light on right side **83WL-R**



### 8" Splash Pan

12" high x 8" wide x 12" deep [30cm x 20cm x 30cm] with insert pan.

Ea.  
Without light **84NL**  
Light on left side **84WL-L**  
Light on right side **84WL-R**

Aluminum

## Splash Pans w/Shield

### 6" Splash Pan w/Shield

12" high x 6" wide x 10" deep  
[30cm x 15cm x 25cm] with insert pan.

Ea.  
Without light **83NL-S**

### 8" Splash Pan w/Shield

12" high x 8" wide x 12" deep [30cm x 20cm x 30cm] with insert pan.

Ea.  
Without light **84NL-S**  
Light on left side **84WL-LS**  
Light on right side **84WL-RS**



Acrylic

## Splash Pans Shield

A clear, acrylic shield for placement onto existing or new splash hood. Manufactured of clear acrylic, the 6" wide x 9" long [15cm x 23cm] shield is adjustable to any vertical position within 180° for maximum protection from flying debris and wet pumice.

Ea. **86B**



White

## Germicide Tray

Sturdy plastic construction, stainless steel lid, 1 qt. capacity and one-step lift and drain. Can be recessed into counter top (template available upon request). Compatible with most chemical disinfectants and sterilants. 10.75" x 5" x 2.75".

Ea. **31046**



Perforated

## Instrument Steri Container

8.5" x 2" x 1.75", white, autoclavable to 250°F.

Ea. **203SC-1**

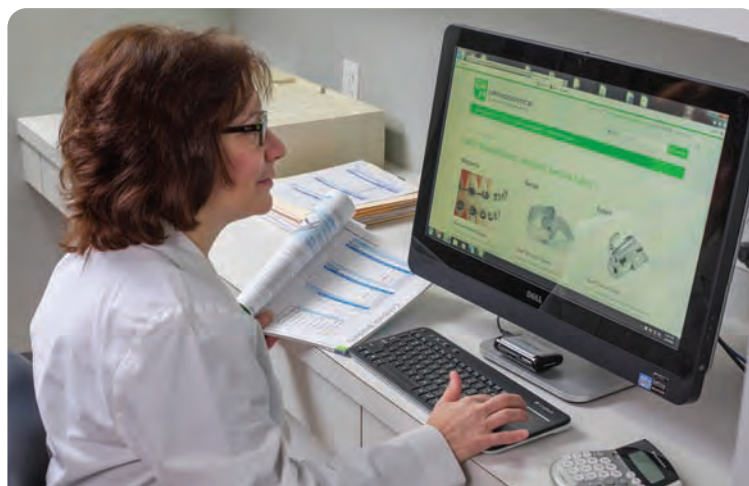
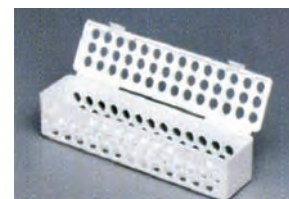

**Ordering G&H Products Online is Easy!**

Use our "Quick Reorder" feature to reorder frequently purchased products - it's quick and easy!  
[GHOrthodontics.com](http://GHOrthodontics.com)

## G&H® Equipment

Air Vac XQ

### Vacuum Former 110v

Utilizes compressed air to create all types of orthodontic appliances in less time, with precise adaptation and superior accuracy. 5-year warranty on parts and labor.

- Virtually silent operation
- "Bead well" feature
- Lab quality results
- Compact & lightweight
- 5-year parts & labor guarantee

Ea. **7000470**



ProForm 2

### Vacuum Former 110v

- Dual chamber
- All aluminum construction
- Two-post sliding frame
- Center based vac motor
- 5-year parts & labor guarantee

Ea. **9594130**



ProForm Express

### Vacuum Former 110v

- Non-rotating hexagonal post
- All aluminum construction
- Symmetrical heating unit
- 5-year parts & labor guarantee

Ea. **9594470**



Econo Vac III

### Vacuum Former 110v

- Heavy-duty spring & latch
- All aluminum construction
- Symmetrical heating unit
- 5-year parts & labor guarantee

Ea. **7000330**



Trim-Rite®

### Release Agent

Trim-Rite® release agent provides guaranteed separation between the working cast and the thermoformed plastic. Will not turn plastic yellow.

Ea. **21004**



Wall Mount

### Safelight

5 1/2"

Ea. **SL105**



Wall Mounted

### Cephalostat

Wall mounted with standard set-up.

Ea. **102**



Wehmer®

### Film & Digital Cassette

8" x 10" with stops.

Ea. **4201**

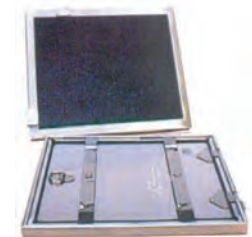

Kodak®

### Lanex Intensifying Screens

Rarex earth/green.

Ea. **4581**



Deluxe

### Cephalometric Chair

450 lb. lift column and remote foot pedal.

Ea. **106**



Portable

### Ceph Viewing Box

This lightweight, portable viewer is ideal for tracing, cephalometric examination, and patient consultations. Durable all metal construction with two 8 watt fluorescent lamps for easier viewing.

Ea. **S701-01**



# INDEX

## A

Acetate Tracing Paper .....	118
Acrylic Resin .....	144
Adhesives .....	82
Aesthetic Archwires .....	60
Air/Water Syringe Tips .....	88
Alcohol .....	141
Alginate .....	112, 113
Alginate Flavoring .....	113
Alginate Mixer .....	113
Alginate Remover .....	116, 138
Alginate Spatulas .....	112
Alginator .....	113
Alginator Bowl .....	113
Aluminum Oxide .....	147
Anesthetic, Topical .....	122
Angulator .....	150
Antibacterial Hand Soap .....	140
Applicators, Mini Tips .....	86
Apron Hangers .....	126
Apron, X-Ray .....	126
Archforms .....	37
Archwire Dispenser .....	39
Archwire Force Graphs .....	41
Archwire Marking Pencils .....	118
Archwire Protective Tubing .....	74
Archwire Storage Box .....	36
Archwire Testing .....	40
Articulating Paper .....	122
Australian Wire Arches .....	68
Australian Wire Combination .....	68
Australian Wire Products .....	67
Australian Wire, Spooled .....	67
Australian Wire, Straight .....	67
Autoclave Cleaner .....	138
Autoclave Sterilizer .....	146
Auxiliary Attachments .....	34

## B

Ball Clasps .....	65
Ball Post Archwires .....	59
Bands	
Bicuspid Bands .....	33
Saturn™ Molar Bands .....	32, 33
Titan™ Molar Bands .....	30, 31
Barrier Film, Surface .....	142
Barrier Milk .....	104
Barriers, Multi-Use .....	142
Beta Titanium .....	55
Beta Titanium T-Loop .....	55
Bib Holders .....	124
Bibs, Patient .....	124
Bite Block Cover .....	142
Bite Registration Material .....	114
Bite Stick .....	103
Bite Wafers .....	135, 143, 144
Bite-Bumper™ .....	91
Bonded Retainer Overview .....	63
Bonding Aligner Adhesive .....	82
Bonding Brushes .....	86
Bowls, Mixing .....	115
Brace Relief .....	135
Bracket Tray .....	87
Bracket Tray Holder .....	87
Brackets, Cosmetic	
Prism™ Composite .....	17, 18, 19
Vapor™ Ceramic .....	14, 15, 16
Brackets, Metal .....	2
Agility® Self-Ligating .....	10, 11, 12, 13
Focus™ .....	7, 8, 9
miniPrevail™ .....	3, 4, 5, 6
Brass Separating Wire .....	66
Brush Tips .....	86
BT3™ Beta Titanium .....	55
Buccal Tubes	
Magnum™ .....	24, 25, 26, 27, 28
Viper™ Low Profile .....	20, 21, 22
Viper™ Low Profile Convertible .....	23
Burs .....	107, 108, 109, 110

Burs & Points .....	107
Burs, Diamond .....	108
Burs, Interproximal .....	108
Buttons .....	34

## C

Caliper, Digital .....	105
Canes .....	74
Cavicide® Disinfectant .....	137
Caviwipes® .....	136
Ceph Film .....	127
Ceph Viewing Box .....	157
Cephalometric Chair .....	157
Cephalometric Tracing Paper .....	144
Cephalostat .....	157
Cervical Neckpads .....	95
Chain Dispenser .....	79
Chain, Polymer .....	80
Chain, Powerlinx™ .....	80
Chair Covers .....	123
Check Bite .....	144
Cheek Retractors .....	89
Chewies .....	131
Chilling Instrument .....	103
Chin Cup Headcaps .....	95
Chucks .....	149
Cleaner, Film Processor .....	128
Cleaner, General Purpose .....	137
Cleaners .....	137
Cleats .....	34
Clinical Supplies .....	81
Coil Eyelets .....	34
Colboloy™ Blue .....	66
Compound Sticks .....	143
Copper Nickel Titanium .....	43
Copwax .....	144
Cotton Dispenser .....	140
Cotton Pellets .....	87
Cotton Roll Dispenser .....	140
Cotton Roll Holder .....	139
Cotton Rolls .....	139
Cotton Tip Applicators .....	140
Crimpable Stops .....	71
CSR Wrap .....	139
Cup Holders .....	122
Cups, Plastic .....	122
Curing Light .....	92
Curing Light Tip Shields .....	92
Cutter, Carbide .....	108
Cutting Burs .....	108

## D

Dappen Dish .....	87
Debubblizer .....	116
Demonstration Models .....	135
Developer, Film Chemistry .....	127
Disc Mandrels .....	110
Disc Safety Guard .....	110
Discide® .....	136
Discide® Ultra .....	137
Disclosing Tablets .....	132
Discs & Cutters .....	109, 110
Disinfecting Tray .....	142
Dispensing Tips .....	86
Dry Angles .....	88
Dry Field Kits .....	90
Dry Heat Indicator Labels .....	139
Dry Tips .....	88
Duplicating Film .....	127
Dust Collector .....	147
DYB™ Archforms .....	39
DYB™ Archwires .....	50

## E

Efferzyme Tablets .....	138
Ejectors .....	88
Elastic Lugs .....	34
Elastic Power Thread .....	74
Elastic Tubing .....	74
Elastics Placement Tools .....	135
Elastics Storage Key Rings .....	135
Elastics, Enchanted Series .....	75
Elastics, Extreme Sports Series .....	75

Elastics, Non-Latex .....	74, 78
Elastomeric Chain .....	79
Dyna-Link™ Chain .....	79
PowerLinx™ Chain .....	80
Slim-Chain™ .....	79
Elastomeric Chain Dispenser .....	79
Elastomeric Color Chart .....	78
Elastomeric Display Booklet .....	78
Elastomeric Ligature Ties .....	77
Elastomeric Products .....	73
Elastomeric Separators .....	74
Elastomerics .....	73
Enzymatic Cleaner .....	136
Evac System Cleaner .....	137
Evacuation Screens .....	88
everStick® Ortho .....	96
Expansion Screws .....	72
Expansor Keys .....	143
Extrusion Hooks .....	90
Eyelets .....	34

## F

Face Masks, Cone .....	125
Face Masks, Ear-Loop .....	125
Face Masks, Protraction .....	93
Face Masks, Reverse Pull .....	93
Face Masks, Tie-On .....	125
Facebows .....	94
Fiber Reinforced Composite .....	96
Film Cassettes .....	157
Film Chemistry .....	127
Film Processor .....	128
Finishing Appliance .....	97
Fixer, Film Chemistry .....	128
Floss .....	132
Floss, Threaders .....	131, 132
Flosser, Power .....	131
Fluoride Flux Paste .....	145
Fluoride Gel .....	134
Flux .....	145
Force Gauge .....	101
Fuji Ortho .....	86
Fuji® Film Supplies .....	127

## G

G4™ Nickel Titanium .....	44
G4™ Pre-Stopped NiTi .....	47
Gauze Sponges .....	140
Germicidal Detergent .....	138
Germicide Tray .....	156
Glasses, Safety .....	141
Glasses, UV .....	141
Glove Rack .....	126
Gloves .....	125
Gloves, Latex .....	125
Gloves, Nitrile .....	125, 126
Gloves, Vinyl .....	126

## H

Hand Instruments .....	101
Band Pusher .....	101
Band Seater .....	101
Bracket Holder .....	102
Bracket Positioner .....	102
Distal Bender .....	101
Explorer .....	101
Hemostat .....	102, 103
Ligature Director .....	101
Separating Plier .....	103
Tweezer .....	102
Hand Lotion .....	140
Hand Sanitizer .....	141
Hand Soap .....	140
Hand Spray Dispenser .....	141
Hand Spray, No-Rinse .....	140
Handle Protector .....	142
Handpiece Lubricating Oil .....	106
Handpiece Motors .....	105
Head Caps, High Pull .....	95
Headgear Accessories .....	95
Headgear Pouches .....	95
Headgear Storage Cases .....	95
Headrest Covers .....	122, 123



Heatless Stone .....	145
Holders, Mask .....	124
Hooks .....	71

## I

Impression Material .....	113, 114
Impression Supplies .....	115
Impression Tray adhesive .....	114
Impression Tray Adhesive Spray .....	116
Impression Tray Cleaner .....	116, 117
Impression Tray Wax Strips .....	112
Impression Trays .....	111
Impression Trays, Disposable .....	111
Impression Trays, Metal .....	112
Instrument Code Rings .....	105
Instrument Holder .....	104
Instrument Racks .....	103
Instrument Replacement Pads .....	103
Instrument Steri Container .....	156
Instruments, Hand .....	101
Instruments/Pliers .....	98
Adhesive Removing Pliers .....	100
Arch Forming, Tweed Style .....	99
Band Removing Pliers .....	100
Bird Beak Pliers .....	100
Bracket Removing Pliers .....	100
Crimping Pliers .....	100
Cutter, Distal End .....	98
Finishing Pliers .....	100
Jaraback Pliers .....	99
Loop Forming .....	99
Pin & Ligature Cutter .....	98
Separating Plier, Elastomeric .....	103
Three Jaw Pliers .....	99
Utility Pliers, HOW .....	99
Utility Pliers, Weingart .....	99
Wire Contouring Pliers .....	100
Wire Cutter, Safety Hold .....	98
Intensifying Screens .....	157
Interproximal Brushes .....	133
Interproximal Picks .....	132
Interproximal Reduction .....	107
Interproximal Strippers .....	109

## K

Ketac-Cem™ .....	86
Koby Ties .....	66
Kodak® Film Supplies .....	127

## L

Latex Gloves .....	125
Lathes .....	149, 150
LED Curing Light .....	92
LEDEX™ Curing Light .....	92
Ligature Ties, Elastomeric .....	77
Bambino™ Ties .....	77
Mini-Ties .....	77
Select-Ties .....	77
Versa-Ties™ .....	77
Ligature Ties, Pre-Cut .....	66
Ligature Ties, Stainless Steel .....	66
Ligature Wire, Spooled .....	66
Lightning Strips .....	107
Lingual Archforms .....	38
Lingual Archwire (Australian) .....	63
Lingual Archwires .....	61, 62
Lingual Archwires (Preformed) .....	61
Lingual Archwires (Universal) .....	62
Lingual Attachments .....	34
Lingual Buttons .....	34
Lingual Cleats .....	34
Lingual Retention .....	96
Lingual Sheaths .....	34
Lip Bumpers .....	94
Lip Protectors .....	135
Lip Retractors .....	89
Looped Stainless Archwires .....	58
Lysol® Spray .....	136

## M

M5™ Copper Nickel Titanium .....	42, 43
MacroCab .....	146
Magnifier .....	145

Mandrels .....	110
Marking Film, Occlusal .....	122
Mask Holders .....	124
Measuring Gauges, Springs .....	104
Mesh Basket .....	156
Metricide 28™ Sterilant .....	137
Micro Etchers .....	147, 148
Micro Etching Supplies .....	148
Micro Motor .....	148, 149
Micro Torch .....	145
Microbrushes® .....	86
MicroCab+ .....	146
MicroCide 28® Sterilant .....	137
MicroEtcher II .....	147
Mini-Mold™ Kits .....	91
Mirror Cleaning Instructions .....	119
Mirror Handles .....	121
Mirrors, Mouth .....	121
Mirrors, Photographic .....	119
Mirrors, Stainless Steel .....	119
Mixing Bowls .....	115
Mixing Pads .....	87
Mixing Spatulas .....	87
Mixing Tips .....	86
Mixing Wells .....	87
Model Base Formers .....	118
Model Glow Soap .....	118
Model Plasters .....	117
Model Split Cast Formers .....	118
Model Stones .....	117
Model Storage Boxes .....	118
Models, Demonstration .....	135
Moisturizing Spray .....	116
Motors, Handpiece .....	105
Mouth Guards .....	130, 131
Mouth Mirrors .....	121
Mouth Props .....	89
Mouthguard Resin Material .....	145
Mouthwash .....	134
Multi-Strand Stainless Steel .....	64

## N

Neckpads, Headgear .....	95
Neet Springs .....	65
NeoDrys .....	88
NEOsmile™ Tooth Positioner .....	97
Nickel Cobalt Archwires .....	66
Nickel Cobalt Straight Lengths .....	65
Nickel Titanium Archwires .....	45
DYB™ Pretorqued Archwires .....	50, 51
G4orce™ NiTi .....	46
G4™ NiTi Archwires .....	45
Lingual Archwires .....	61
M5™ Copper Nickel Titanium .....	42, 43
Pre-Stopped G4™ NiTi .....	47
Pretorqued Archwires .....	52
Pretorqued Reverse Curve NiTi .....	54
Reverse Curve NiTi .....	53
NiTi Coil Springs .....	70

## O

Occlusal Appliance .....	91
Occlusal Marking Film .....	122
Operation Tubes .....	123
Opti-Cide 3® Disinfectant .....	136
Oral Evacuators .....	88
Orange Solvent .....	117
Ortho Emergency Kit .....	132
Ortho Survival Kit .....	133
Overbite Ruler .....	104

## P

Palatal Bars .....	71
Palatal Expanders .....	72
Paper Towels .....	141
Paragon™ Instruments .....	98
Patient Health Care Kit .....	133
Patient Relief Silicone .....	134
Patient Relief Wax .....	134
Patient Wax Packs .....	134
Photographic Mirror Handle .....	121
Photographic Mirrors .....	119
Photographic Mirrors, Dimensions .....	120

Photographic Retractors .....	89
Plaster Bin .....	153
Plaster Trap Buckets .....	153
Plaster Trap Hoses .....	153
Plaster Trap Kits .....	153
Plaster Trap Liners .....	153
Plaster Trap, Metal .....	153
Plaster/Stone Remover .....	138
Plasters .....	117
Plastics, Sheets .....	145
Platinum Proportion Archwires .....	48, 49
Plier Racks .....	103, 104
Pliers, Bracket Removing .....	100
Pliers, Wire Forming .....	99
Polishing Brushes .....	110
Posted Stainless Steel .....	59
Pre-Stopped NiTi .....	47
Pressure Pots .....	153
Pretorqued NiTi Archwires .....	52
Private Logo Elastics .....	76
Processor Cleaner .....	128
Procide-D™ Sterilant .....	137
Progressive Force NiTi .....	46
Prophy Angles .....	106
Prophy Cups .....	106
Prophy Paste .....	106
Protraction Face Masks .....	93
Pumice .....	107
Pumice Cups .....	106

## Q

Quad-Helix Expanders .....	71
----------------------------	----

## R

Radiometer .....	92
Radiopaque Separators .....	74
Rag Wheel .....	145
Refrigerant Spray .....	145
Release Agent .....	157
Releasing Agent .....	144
Reliance® Bonding Supplies .....	82
1st & Final™ .....	85
Assure® Sealant .....	83
Assure™ .....	82
Band-Lok™ .....	84
Button Hook Aligner Attachment .....	82
Crown Lok™ .....	84
Enhance L.C.™ .....	85
Etchant .....	85
Excel® .....	83
Faci Forms .....	84
Flow Tain™ .....	82
Hilgers Bond-A-Braid™ .....	85
L.C.R.™ .....	82
Light Bond® .....	82
Maximum Cure® .....	83
Metal Conditioner .....	85
Ortho Flex-Tech™ .....	85
Pad Lock™ .....	82
Perfect-a-Smile™ .....	85
Phase II™ .....	83
Plastic Conditioner .....	85
Pontic Paint .....	85
Porc-Etch™ .....	85
Precedent® .....	84
Pro Seal™ .....	83
Quick Cure™ .....	82
Rely-A-Bond® .....	83
Renew Finishing System™ .....	85
S.E.P.™ Self-Etching Primer .....	85
Therma-Cure™ .....	82
Ultra Band-Lok™ .....	84
Veneer Paste .....	84
Resin Material, Mouthguard .....	145
Resin, Ortho .....	144
Retainer Brite .....	131
Retainer Cases .....	130
Retainer Material .....	144
Retention Systems .....	85
Retraction Loops .....	58
Retractors .....	89
Reverse Curve .....	53
Reverse Pull Face Mask .....	93

Rotation Wedges .....	74
Ruler 104 .....	
Ruler, Overbite .....	104
<b>S</b>	
Safelight .....	157
Safety Glasses .....	141
Safety Release Modules .....	94
Saliva Ejector Traps .....	88
Saliva Ejectors .....	88
Sand Blast Containment .....	146
Sand Traps .....	148
Sani-Cloth® Wipes .....	136
Sani-Tube® .....	139
Sanitex Plus® .....	136
Seating Lugs .....	34
Separating Medium .....	115
Sharps Containers .....	142
Sheaths .....	34
Shepherd Hooks .....	71
Shur Wax .....	144
Silver Solder .....	65
SmartBond® Adhesive .....	90
Soft Stainless Steel Wire .....	65
Soft-Picks .....	132
Solder .....	145
Solder (Silver) .....	65
Solder, Silver .....	145
Solder, Straights .....	145
Solder, Tape .....	145
Sonic Cleaner .....	131
Spatulas, Knives .....	115
Spatulas, Mixing .....	87
Spatulators, Vacuum .....	154
Splash Pan Shields .....	156
Splash Pans .....	156
Sponge Pellets .....	87
Sponges, Gauze .....	140
Spooled Wire .....	65
Sporox II® Sterilant .....	137
Springs (Molar Distalizing) .....	71
Springs Section .....	65, 69, 70, 71, 72
Closed Coil Kits .....	69
Closed Coil TAD Springs .....	69
Closed Coil w/Eyelets .....	69
Nickel Titanium Springs .....	69
TAD Spring Kits .....	69
Springs, Stainless Steel .....	70
Stain Remover, Instrument .....	104
Stainless Steel Archwires .....	56
Heat-Treated Stainless Steel .....	57
Lingual Archwires .....	62
Looped Archwires .....	58

Multi-Strand Stainless Steel .....	64
Posted Archwires .....	59
S304 Stainless Steel Archwires .....	56
Tooth-Colored Archwires .....	60
Starter Solution, Film Chemistry .....	128
Sterilants .....	137
Sterilization Indicator Tape .....	139
Sterilization Pouches .....	138, 139
Sterilization Strips .....	139
Sterilizer, Autoclave .....	146
Sterilizer, Dry Heat .....	146
Sterilizer, Steam .....	146
Stones & Plasters .....	117, 118
Stones, Mounted .....	107
Stops 71 .....	
Straight Lengths .....	65
Stranded Archwires .....	64
Surgical Hooks .....	71
Surgical Milk .....	104
Syringe Tips, Metal .....	88
Syringe Tip Cover .....	142
Syringe Tip Dispenser .....	87

<b>T</b>	
T-Light Handle Protector .....	142
TAD Springs .....	69
Tartar & Stain Remover .....	136
Teaching Aids .....	135
Teeth Whitening .....	132
Therma Frost™ Chilling Spray .....	43
Therma-Stick™ Chilling Instrument .....	43
Threaders, Floss .....	132
Timers, Toothbrushing .....	134
Titanium Molybdenum .....	55
Tongue Blocks .....	88
Tongue Depressors .....	140
Tongue Filler .....	115
Tooth Dryer .....	105
Tooth Positioner .....	97
Tooth-Colored Archwires .....	60
Toothbrushes .....	134
Toothbrushes, Disposable .....	134
Toothbrushes, Travel .....	133
Toothbrushing Timers .....	134
Topical Anesthetic .....	122
Torch, Micro .....	145
Towel Holder .....	141
Towels, Paper .....	141
Towels, Poly .....	124
Tracing Paper, Acetate .....	118
Tray Covers .....	123
Tray Racks .....	123
Tray Sleeves .....	123

Trays, Divided .....	123
Trays, Flat .....	124
Trimmer Accessories .....	151
Trimmer Work Light .....	152
Trimmers .....	150, 151
Trimmers, Diamond Wheel .....	150
Tub Racks .....	123

<b>U</b>	
Ultrasonic Cleaner .....	136, 137, 138
Ultrasonic Equipment .....	155
Ultrasonic Units .....	155

<b>V</b>	
Vacuum Former .....	157
Vacuum Mixer Accessories .....	154
Vacuum Mixers .....	154
Vacuum Spatulators .....	154
Vibrators .....	152, 153
Viper Combination Convertible™ .....	24

<b>W</b>	
Waste Bags, Bio-Hazard .....	141
Waterbath .....	154, 155
Waterline Maintenance Tablets .....	138
Wax, Beauty .....	143
Wax, Bite Registration .....	116
Wax, Bite Sheets .....	116, 143
Wax, Coprwax .....	144
Wax, Impression .....	116
Wax, Modern Pink .....	144
Wax, Pink 10X .....	143
Wax, Red Base Plate .....	144
Wax, Sticky .....	143
Wax, Utility Strips .....	143, 144
Waxed Cloth .....	116
Welding Equipment .....	156
Wet Field Adhesive .....	90
Whitening System .....	132
Wipes, Disinfectant .....	136
Wire Cutter .....	98
Wire Forming Pliers .....	99
Wire Products .....	35

<b>X</b>	
X-Ray Apron .....	126
XR1™ Heat-Treated Archwires .....	57

<b>Z</b>	
Zoo Animal Teaching Aids .....	135

## Payment Options

Net 30 days, upon credit approval. Past due balances may be charged 1.5% per month finance charge at the sole discretion of G&H®. G&H® accepts Mastercard, Visa and American Express for any purchase. When using credit cards, please provide complete name, card number and expiration date, and CV2 code. We request a minimum order of U.S. \$25 to help keep processing costs down.

## Pricing and Policies

Product pricing is available online for G&H® customers by logging onto the G&H® website with your customer number and password. Or, you can call us at 1-800-526-1026 during our regular office hours and our customer service representatives will be happy to assist you.

We are constantly engaging in research to improve our quality and design. Therefore, G&H® reserves the right to improve, modify, or discontinue products at any time without prior notice. All prices are in U.S. funds and are subject to change without notice. Purchaser assumes all risk and liability resulting from the use of these products. In the event of any claimed defect, G&H®'s sole responsibility is limited to the replacement of the material, or at G&H®'s option, issuing credit for the purchase price. G&H® will not be responsible for other claims for incidental and consequential

damages. Any and all implied warranties of merchantability or fitness for any particular purpose or use are waived and excluded.

## Return Policy

G&H® warrants all materials and workman-ship to be free from defects. Products must be returned within 90 days from date of purchase and must be returned in original packaging and in resalable condition. G&H® reserves the right to final determination as to acceptance of product for exchange or credit. Restock fees may apply. Prior to the return of any merchandise, please contact G&H® Customer Service for a return authorization number.

## Shipping Options

All domestic and international orders are shipped via UPS unless a specific carrier is preferred and approved prior to ordering. Alternate shipping services are available including express or overnight shipping where available - please call for more information.

## Trademarks

G&H, OrthoForce, Ortho Club, ODP, miniPrevail and the G&H logo are registered trademarks of G&H Wire Company. The following trademarks/ service marks and copyrights in this catalog are the property of G&H® Wire Company:

Accu-Lock, Agility, Comfort Zone, Focus, Magnum, Lucent, Prism, Mirage, Clarion, Diamante, Viper, Vapor, Titan, Saturn, Paragon, Armada, Excelsior, G4, M5, XR1, BT3, G4orce, Zenith, SureGrip, Embrace, Edge-Lok, Enforce frc, Colboloy, Straight-Line, Ultraesthetic, Enchanted, Slim-Chain, Dyna-Link, Versa-Tie, Bambino-Tie, Solo-Pack, Europa, Trueform, Thermo-Frost, Thermo-Stick, NEOsmile, DYB, "With G&H® OrthoForce® orthodontic archwires, you are always in control.", "Nobody knows NiTi like G&H®".

All other trademarks are property of their respected owner.

© 2016 G&H® Orthodontics

G&H® Wire Company holds certification for ISO 13485:2003 and the Medical Device Directive 93/42, 2007/47/EC as well as the Canadian Medical Device Guidelines.



**G&H® makes brackets in the U.S.A., and that makes the difference.**



**G&H® BRACKETS MOST PREFERRED BY ORTHODONTISTS**

Vapor™ Ceramic Bracket System | miniPrevail® Metal Bracket System



Bracket features at-a-glance

**State-of-the-art engineering and the highest-quality materials**

	miniPrevail®	Vapor™
Mini twin design for comfort and control	✓	✓
Distinctive compound contoured mesh bonding base for anatomical fit	✓	
Revolutionary bonding base - adhesive flows through the portals for unprecedented secure bonding and safe debonding		✓
MIM*   CIM* manufactured for bracket strength	✓	✓
Parallel tie wings / Rhomboidal shape	✓	✓
<b>No special debonding instrument required</b>	✓	✓
<b>Excellent value - manufacturer pricing</b>	✓	✓
<b>Available in popular bracket prescriptions</b>	✓	✓
Roth	✓	✓
High Torque	✓	✓
MBT	✓	✓
Edgewise	✓	✓
Nearly invisible, aesthetic appearance		✓
Temporary color-coded ID system with permanent identification indents for ease of use	✓	✓
Full rotational control	✓	✓
Low profile and rounded facial contours for patient comfort	✓	✓



*Have questions about our brackets?*

call: **888-723-7860**

\*MIM - Metal Injection Molding, CIM - Ceramic Injection Molding



**ORTHODONTICS®**

Quality Manufacturing. Exceptional Service.



## Over 6,000 Products! Brand Names You Know and Trust

**The Club With Clout!** Your membership in the unique G&H OrthoClub results in big savings for you. Enjoy buying-group savings on brand-name clinical supplies as well as all G&H manufactured products, plus get special member only offers and discounts. Join the club and save!

[GHOrthoClub.com](http://GHOrthoClub.com)



**BRACKETS**



**BANDS**



**TUBES**



**WIRES**



**SPRINGS**



**ELASTOMERICS**

Precision engineered and manufactured in the U.S.A.

**GHOrthodontics.com**

2165 Earlywood Drive Franklin, IN 46131 USA

888-723-7860 U.S. & Canada +1 317-346-6655 International

Email us at [orders@GHOrtho.com](mailto:orders@GHOrtho.com)



MKT.001.A